

ELECTRICAL CHARACTERISTICS (@TA=25°C unless otherwise specified)

TYPE	V _{ZT@I_{ZT}} (Volts) Nominal	I _{ZT} (mA)	Z _{ZT@I_{ZT}} (Ω) MAX	I _{ZK} (mA)	Z _{Zk@I_{Zk}} (Ω) MAX	I _{R@V_R} (μA) MAX	V _R (Volts)
1N4728A	3.3	76	10	1	400	100	1
1N4729A	3.6	69	10	1	400	100	1
1N4730A	3.9	64	9	1	400	50	1
1N4731A	4.3	58	9	1	400	10	1
1N4732A	4.7	53	8	1	500	10	1
1N4733A	5.1	49	7	1	550	10	1
1N4734A	5.6	45	5	1	600	10	2
1N4735A	6.2	41	2	1	700	10	3
1N4736A	6.8	37	3.5	1	700	10	4
1N4737A	7.5	34	4	0.5	700	10	5
1N4738A	8.2	31	4.5	0.5	700	10	6
1N4739A	9.1	28	5	0.5	700	10	7
1N4740A	10	25	7	0.25	700	10	7.6
1N4741A	11	23	8	0.25	700	5	8.4
1N4742A	12	21	9	0.25	700	5	9.1
1N4743A	13	19	10	0.25	700	5	9.9
1N4744A	15	17	14	0.25	700	5	11.4
1N4745A	16	15.5	16	0.25	700	5	12.2
1N4746A	18	14	20	0.25	700	5	13.7
1N4747A	20	12.5	22	0.25	750	5	15.2
1N4748A	22	11.5	23	0.25	750	5	16.7
1N4749A	24	10.5	25	0.25	750	5	18.2
1N4750A	27	9.5	35	0.25	750	5	20.6
1N4751A	30	8.5	40	0.25	1000	5	22.8
1N4752A	33	7.5	45	0.25	1000	5	25.1
1N4753A	36	7.0	50	0.25	1000	5	27.4
1N4754A	39	6.5	60	0.25	1000	5	29.7
1N4755A	43	6.0	70	0.25	1500	5	32.7
1N4756A	47	5.5	80	0.25	1500	5	35.8
1N4757A	51	5.0	95	0.25	1500	5	38.8
1N4758A	56	4.5	110	0.25	2000	5	42.6



RATING AND CHARACTERISTICS CURVES (1N4728A-1N4758A)

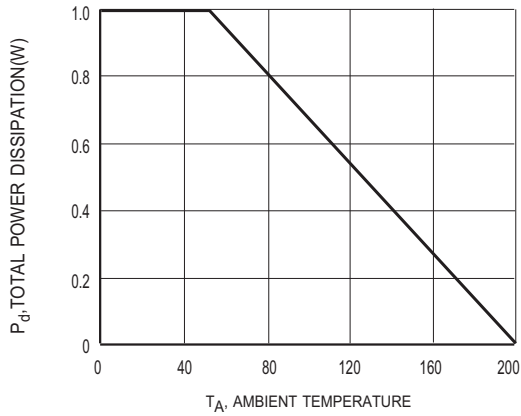

Figure1 Power Dissipation vs Ambient Temperature

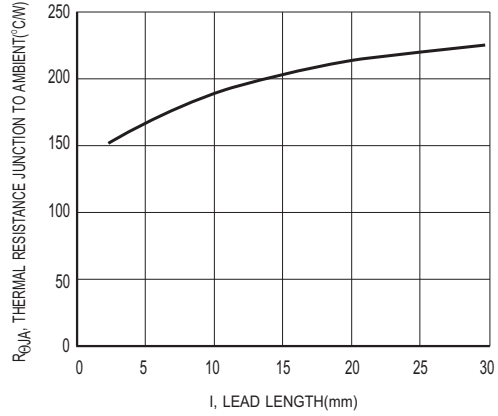

Figure2 Typical Thermal Resistance vs Lead Length

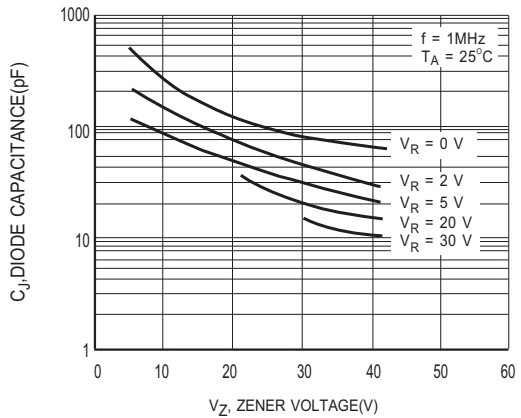

Figure3 Junction Capacitance vs Zener Voltage

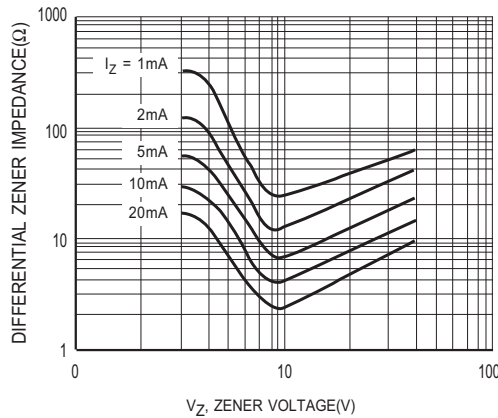

Figure4 Typical Zener Impedance vs Zener Voltage

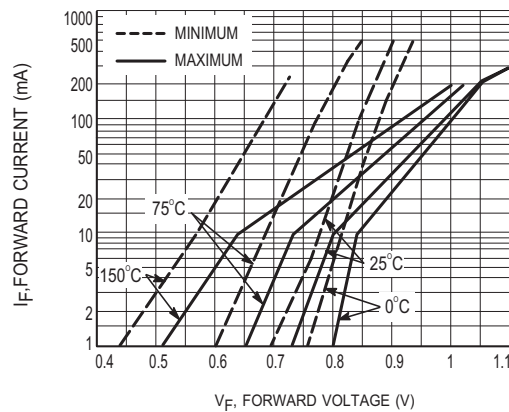

Figure5 Typical Forward Characteristics





Attachment information about 1N4735A

1. Internal Circuit



2. Marking on the body

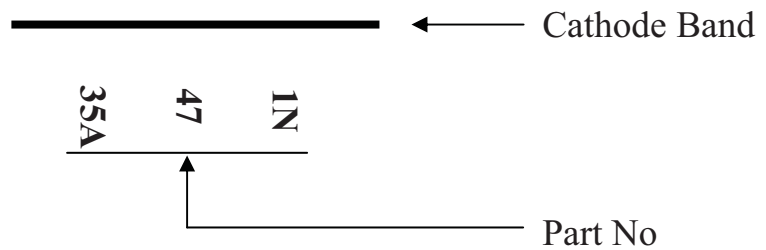

2. MARKING

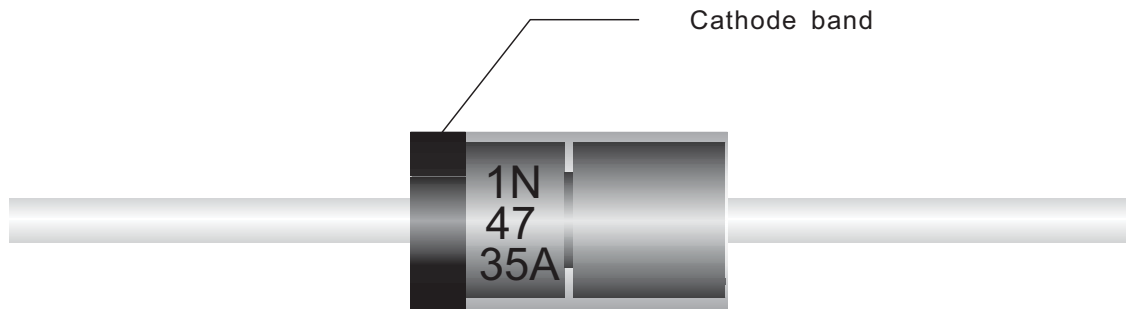

3. TAPING

Axial lead devices are packed in accordance with EIA standard RS-296-E and specifications given below.

COMPONENT OUTLINE	COMPONENT PITCH A ± 0.5mm	INTER TAPE PITCH B ± 1.0mm	CUMULATIVE PITCH TOLERANCE
DO-41G	5.0mm	52.0mm	1.0mm/20pitch

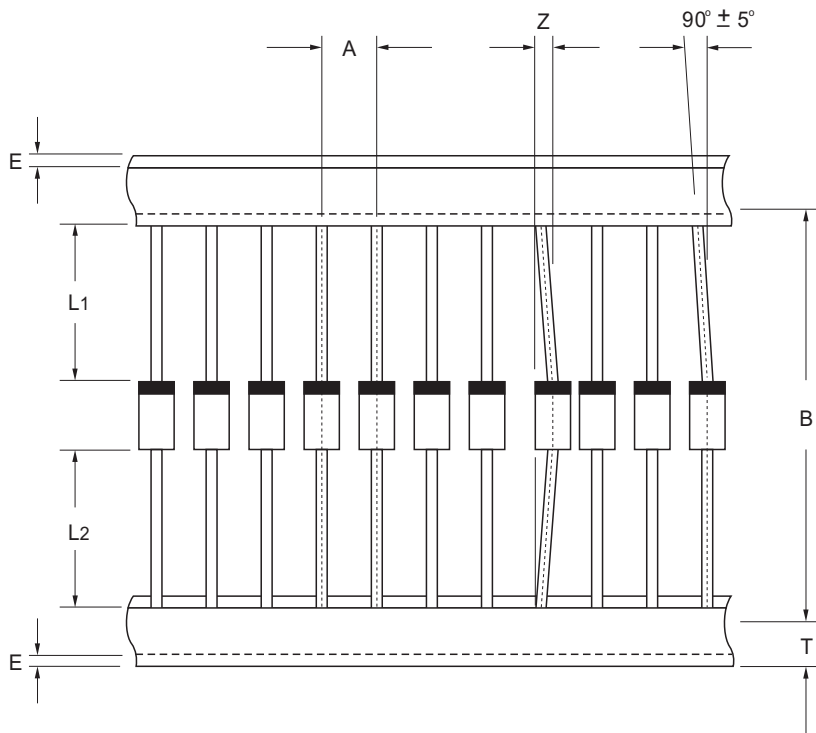

ITEM	SYMBOL	SPECIFICATIONS(mm)	SPECIFICATIONS(inch)
Component alignment	Z	1.2max	0.048max
Tape width	T	6.0±0.4	0.236±0.016
Exposed adhesive	E	0.8max	0.032max
Body eccentricity	L1-L2	1.0max	0.040max

NOTES: Each component lead shall be sandwiched between tapes for a minimum of 3.2mm (0.126")

PACKAGING OF DIODE

BULK PACK

PACKAGE	PACKING CODE	EA PER BOX	INNER BOX SIZE (mm)	CARTON SIZE (mm)	EA PER CARTON	GROSS WEIGHT(Kg)
DO-35	-B	10,000	240*100*100	410*350*275	120,000	21.5
DO-41G	-B	5,000	90*240*100	400*268*225	40,000	12.11

REEL PACK

PACKAGE	PACKING CODE	REEL (EA)	COMPONENT SPACE(mm)	TAPE SPACE (mm)	REEL DIA (mm)	CARTON SIZE (mm)	EA PER CARTON	GROSS WEIGHT(Kg)
DO-35	-T	10,000	5.0	52	356	370*370*420	50,000	11.00
DO-41G	-T	5,000	5.0	52	356	370*370*420	25,000	11.50
SOT-23/-3L	-T	3,000	---	---	178	438*438*220	180,000	---
LL-34	-T	2,500	---	---	178	385*270*220	90,000	7.50
SOD-123	-T	3,000	---	---	178	438*438*220	180,000	9.00
SOD-323	-T	3,000	---	---	178	438*438*220	180,000	9.00
SOT-323	-T	3,000	---	---	178	438*438*220	180,000	9.00
LL-41	-W	5,000	---	---	330	370*370*420	50,000	6.6

AMMO PACK

PACKAGE	PACKING CODE	REEL (EA)	COMPONENT SPACE(mm)	TAPE SPACE (mm)	BOX SIZE (mm)	CARTON SIZE(mm)	CARTON (EA)	GROSS WEIGHT (Kg)
DO-35	-F	5,000	5.0	52	250*80*80	425*270*220	100,000	20.00
DO-41G	-F	3,000	5.0	52	250*80*80	425*270*220	60,000	20.00

DISCLAIMER NOTICE

Rectron Inc reserves the right to make changes without notice to any product specification herein, to make corrections, modifications, enhancements or other changes. Rectron Inc or anyone on its behalf assumes no responsibility or liability for any errors or inaccuracies. Data sheet specifications and its information contained are intended to provide a product description only. "Typical" parameters which may be included on RECTRON data sheets and/ or specifications can and do vary in different applications and actual performance may vary over time. Rectron Inc does not assume any liability arising out of the application or use of any product or circuit.

Rectron products are not designed, intended or authorized for use in medical, life-saving implant or other applications intended for life-sustaining or other related applications where a failure or malfunction of component or circuitry may directly or indirectly cause injury or threaten a life without expressed written approval of Rectron Inc. Customers using or selling Rectron components for use in such applications do so at their own risk and shall agree to fully indemnify Rectron Inc and its subsidiaries harmless against all claims, damages and expenditures.

