

1SMB59xxBT3 Series, SZ1SMB59xxT3G Series

ELECTRICAL CHARACTERISTICS

($T_L = 30^\circ\text{C}$ unless otherwise noted,
 $V_F = 1.5\text{ V Max. @ } I_F = 200\text{ mA(dc)}$ for all types)

Symbol	Parameter
V_Z	Reverse Zener Voltage @ I_{ZT}
I_{ZT}	Reverse Current
Z_{ZT}	Maximum Zener Impedance @ I_{ZT}
I_{ZK}	Reverse Current
Z_{ZK}	Maximum Zener Impedance @ I_{ZK}
I_R	Reverse Leakage Current @ V_R
V_R	Reverse Voltage
I_F	Forward Current
V_F	Forward Voltage @ I_F
I_{ZM}	Maximum DC Zener Current

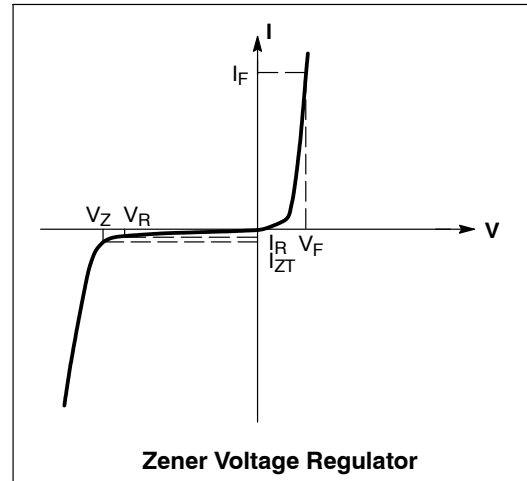

1SMB59xxBT3 Series, SZ1SMB59xxT3G Series

ELECTRICAL CHARACTERISTICS (Devices listed in **bold, italic** are ON Semiconductor Preferred devices.)

($T_L = 30^\circ\text{C}$ unless otherwise noted, $V_F = 1.5\text{ V Max.}$ @ $I_F = 200\text{ mA(dc)}$ for all types)

Device* (Note 2)	Device Marking	Zener Voltage (Note 3)				Zener Impedance (Note 4)			Leakage Current		I_{ZM} mA(dc)
		V_Z (Volts)			@ I_{ZT}	Z_{ZT} @ I_{ZT}	Z_{ZK} @ I_{ZK}		I_R @ V_R		
		Min	Nom	Max	mA	Ω	Ω	mA	μA	Volts	
SZ/1SMB5913BT3, G	913B	3.13	3.3	3.47	113.6	10	500	1	100	1	454
SZ/1SMB5914BT3, G	914B	3.42	3.6	3.78	104.2	9	500	1	75	1	416
SZ/1SMB5915BT3, G	915B	3.70	3.9	4.10	96.1	7.5	500	1	25	1	384
1SMB5916BT3, G	916B	4.08	4.3	4.52	87.2	6	500	1	5	1	348
SZ/1SMB5917BT3, G	917B	4.46	4.7	4.94	79.8	5	500	1	5	1.5	319
SZ/1SMB5918BT3, G	918B	4.84	5.1	5.36	73.5	4	350	1	5	2	294
SZ/1SMB5919BT3, G	919B	5.32	5.6	5.88	66.9	2	250	1	5	3	267
SZ/1SMB5920BT3, G	920B	5.89	6.2	6.51	60.5	2	200	1	5	4	241
SZ/1SMB5921BT3, G	921B	6.46	6.8	7.14	55.1	2.5	200	1	5	5.2	220
SZ/1SMB5922BT3, G	922B	7.12	7.5	7.88	50	3	400	0.5	5	6	200
SZ/1SMB5923BT3, G	923B	7.79	8.2	8.61	45.7	3.5	400	0.5	5	6.5	182
SZ/1SMB5924BT3, G	924B	8.64	9.1	9.56	41.2	4	500	0.5	5	7	164
SZ/1SMB5925BT3, G	925B	9.5	10	10.5	37.5	4.5	500	0.25	5	8	150
SZ/1SMB5926BT3, G	926B	10.45	11	11.55	34.1	5.5	550	0.25	1	8.4	136
SZ/1SMB5927BT3, G	927B	11.4	12	12.6	31.2	6.5	550	0.25	1	9.1	125
SZ/1SMB5928BT3, G	928B	12.35	13	13.65	28.8	7	550	0.25	1	9.9	115
SZ/1SMB5929BT3, G	929B	14.25	15	15.75	25	9	600	0.25	1	11.4	100
SZ/1SMB5930BT3, G	930B	15.2	16	16.8	23.4	10	600	0.25	1	12.2	93
SZ/1SMB5931BT3, G	931B	17.1	18	18.9	20.8	12	650	0.25	1	13.7	83
SZ/1SMB5932BT3, G	932B	19	20	21	18.7	14	650	0.25	1	15.2	75
SZ/1SMB5933BT3, G	933B	20.9	22	23.1	17	17.5	650	0.25	1	16.7	68
SZ/1SMB5934BT3, G	934B	22.8	24	25.2	15.6	19	700	0.25	1	18.2	62
SZ/1SMB5935BT3, G	935B	25.65	27	28.35	13.9	23	700	0.25	1	20.6	55
SZ/1SMB5936BT3, G	936B	28.5	30	31.5	12.5	28	750	0.25	1	22.8	50
SZ/1SMB5937BT3, G	937B	31.35	33	34.65	11.4	33	800	0.25	1	25.1	45
SZ/1SMB5938BT3, G	938B	34.2	36	37.8	10.4	38	850	0.25	1	27.4	41
SZ/1SMB5939BT3, G	939B	37.05	39	40.95	9.6	45	900	0.25	1	29.7	38
SZ/1SMB5940BT3, G	940B	40.85	43	45.15	8.7	53	950	0.25	1	32.7	34
SZ/1SMB5941BT3, G	941B	44.65	47	49.35	8	67	1000	0.25	1	35.8	31
1SMB5942BT3, G	942B	48.45	51	53.55	7.3	70	1100	0.25	1	38.8	29
1SMB5943BT3, G	943B	53.2	56	58.8	6.7	86	1300	0.25	1	42.6	26
SZ/1SMB5944BT3, G	944B	58.9	62	65.1	6	100	1500	0.25	1	47.1	24
SZ/1SMB5945BT3, G	945B	64.6	68	71.4	5.5	120	1700	0.25	1	51.7	22
SZ/1SMB5946BT3, G	946B	71.25	75	78.75	5	140	2000	0.25	1	56	20
SZ/1SMB5947BT3, G	947B	77.9	82	86.1	4.6	160	2500	0.25	1	62.2	18
1SMB5948BT3, G	948B	86.45	91	95.55	4.1	200	3000	0.25	1	69.2	16
1SMB5949BT3, G	949B	95	100	105	3.7	250	3100	0.25	1	76	15
1SMB5950BT3, G	950B	104.5	110	115.5	3.4	300	4000	0.25	1	83.6	13
1SMB5951BT3, G	951B	114	120	126	3.1	380	4500	0.25	1	91.2	12
1SMB5952BT3, G	952B	123.5	130	136.5	2.9	450	5000	0.25	1	98.8	11
1SMB5953BT3, G	953B	142.5	150	157.5	2.5	600	6000	0.25	1	114	10
1SMB5954BT3, G	954B	152	160	168	2.3	700	6500	0.25	1	121.6	9
1SMB5955BT3, G	955B	171	180	189	2.1	900	7000	0.25	1	136.8	8
SZ/1SMB5956BT3, G	956B	190	200	210	1.9	1200	8000	0.25	1	152	7

2. **TOLERANCE AND TYPE NUMBER DESIGNATION** The type numbers listed indicate a tolerance of $\pm 5\%$.

3. **ZENER VOLTAGE (V_Z) MEASUREMENT**

Nominal Zener voltage is measured with the device junction in thermal equilibrium with ambient temperature at 25°C .

4. **ZENER IMPEDANCE (Z_Z) DERIVATION** Z_{ZT} and Z_{ZK} are measured by dividing the ac voltage drop across the device by the ac current applied. The specified limits are for $I_{Z(ac)} = 0.1 I_{Z(dc)}$ with the ac frequency = 60 Hz.

*The "G" suffix indicates Pb-Free package available.

1SMB59xxBT3 Series, SZ1SMB59xxT3G Series

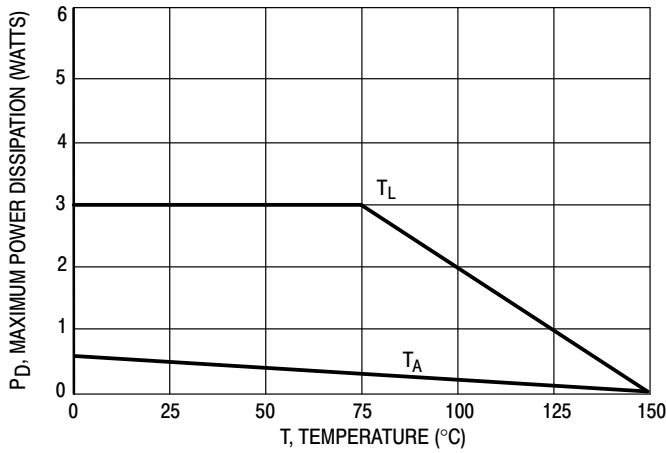

Figure 1. Steady State Power Derating

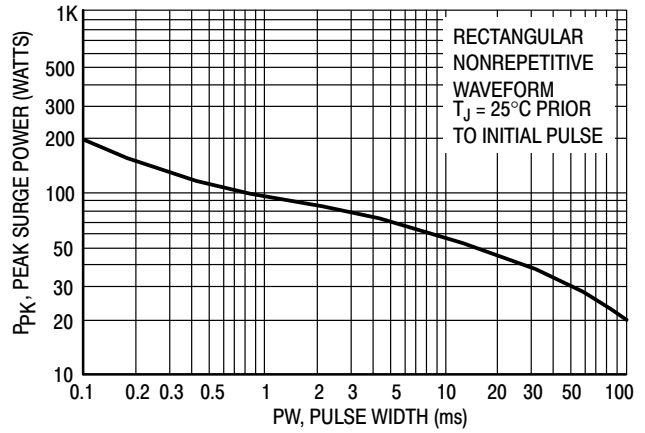

Figure 2. Maximum Surge Power

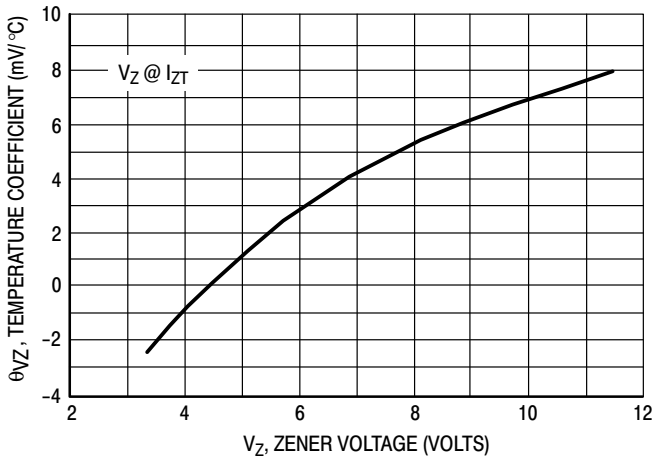

Figure 3. Zener Voltage - To 12 Volts

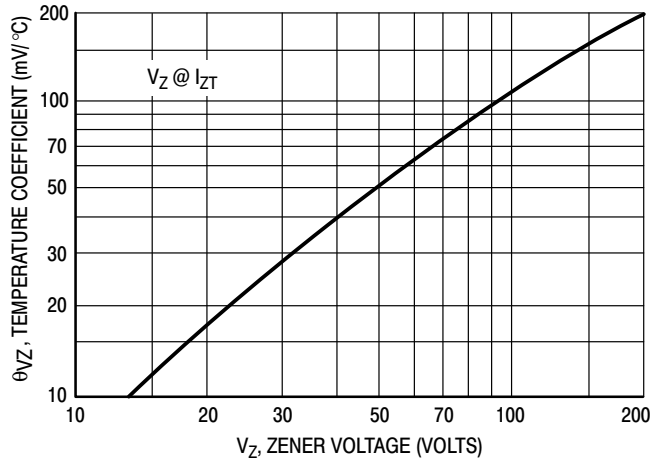

Figure 4. Zener Voltage - 14 To 200 Volts

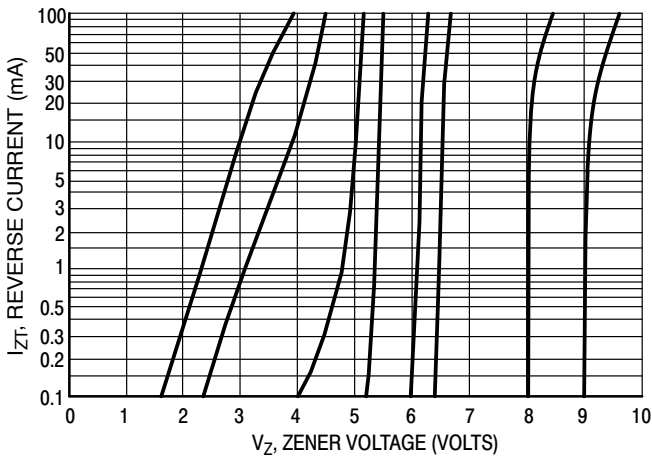

Figure 5. $V_Z = 3.3$ thru 10 Volts

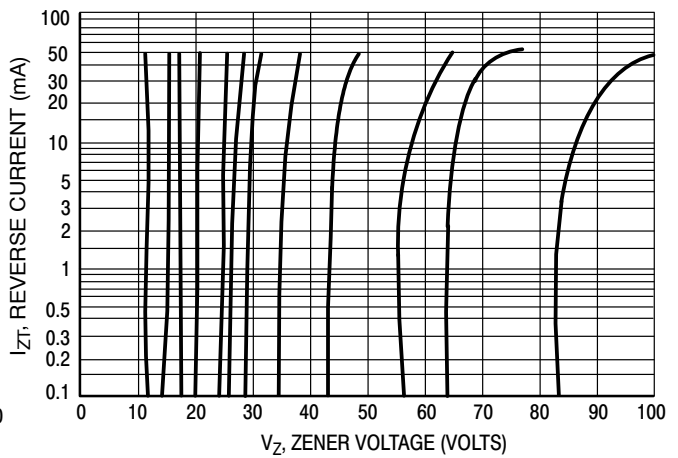

Figure 6. $V_Z = 12$ thru 82 Volts

1SMB59xxBT3 Series, SZ1SMB59xxT3G Series

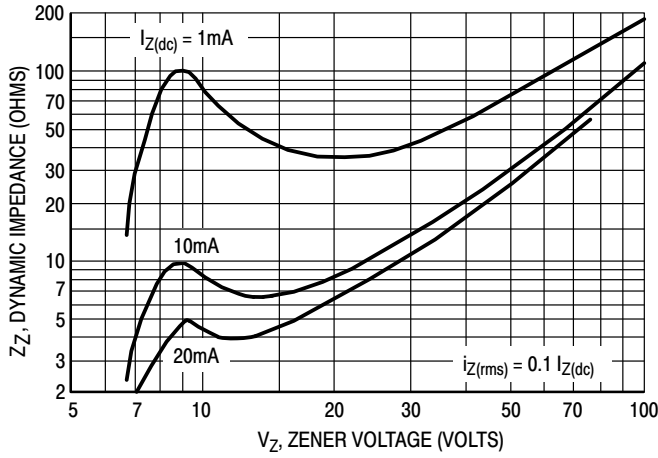

Figure 7. Effect of Zener Voltage

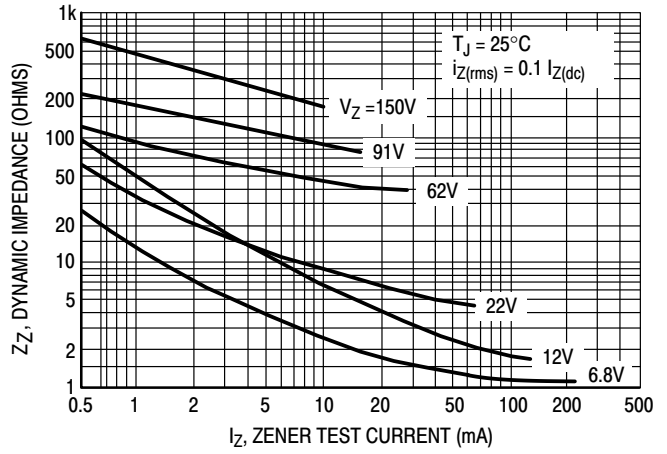

Figure 8. Effect of Zener Current

Rating and Typical Characteristic Curves ($T_A = 25^\circ C$)

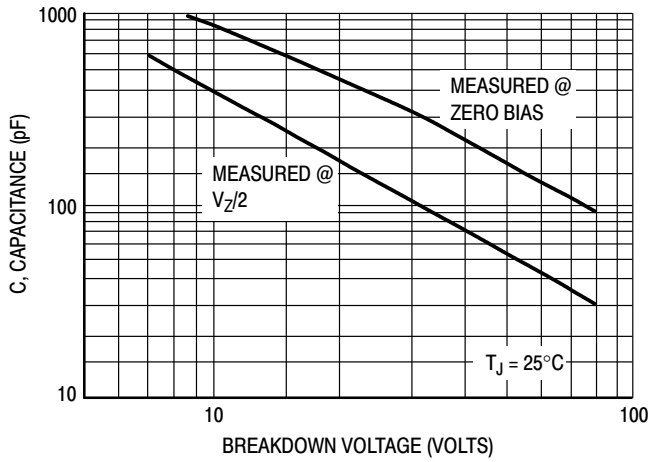

Figure 9. Capacitance Curve

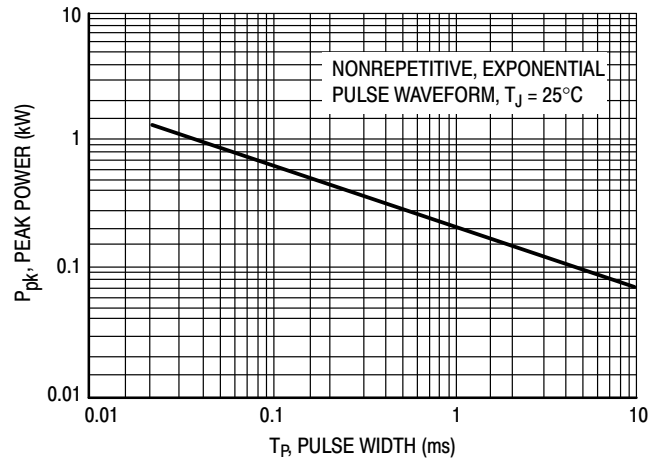

Figure 10. Typical Pulse Rating Curve

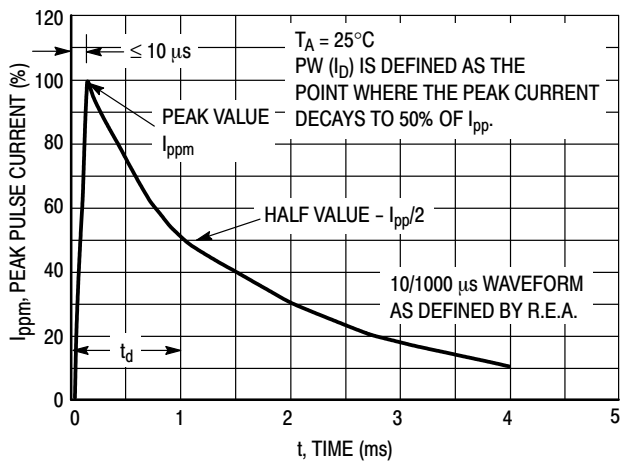

Figure 11. Pulse Waveform

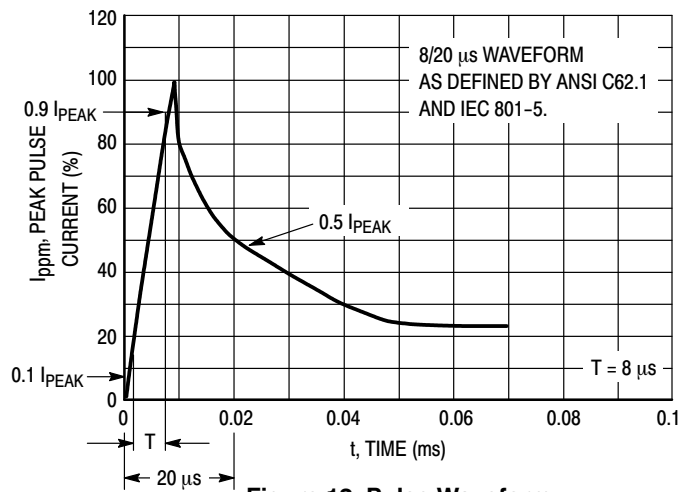
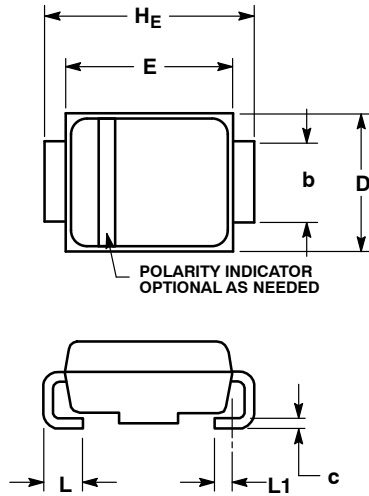

Figure 12. Pulse Waveform

1SMB59xxBT3 Series, SZ1SMB59xxT3G Series

PACKAGE DIMENSIONS

SMB CASE 403A-03 ISSUE H



- NOTES:
1. DIMENSIONING AND TOLERANCING PER ANSI Y14.5M, 1982.
 2. CONTROLLING DIMENSION: INCH.
 3. D DIMENSION SHALL BE MEASURED WITHIN DIMENSION P.

DIM	MILLIMETERS			INCHES		
	MIN	NOM	MAX	MIN	NOM	MAX
A	1.90	2.20	2.28	0.075	0.087	0.090
A1	0.05	0.10	0.19	0.002	0.004	0.007
b	1.96	2.03	2.20	0.077	0.080	0.087
c	0.15	0.23	0.31	0.006	0.009	0.012
D	3.30	3.56	3.95	0.130	0.140	0.156
E	4.06	4.32	4.60	0.160	0.170	0.181
HE	5.21	5.44	5.60	0.205	0.214	0.220
L	0.76	1.02	1.60	0.030	0.040	0.063
L1	0.51 REF			0.020 REF		

SOLDERING FOOTPRINT*

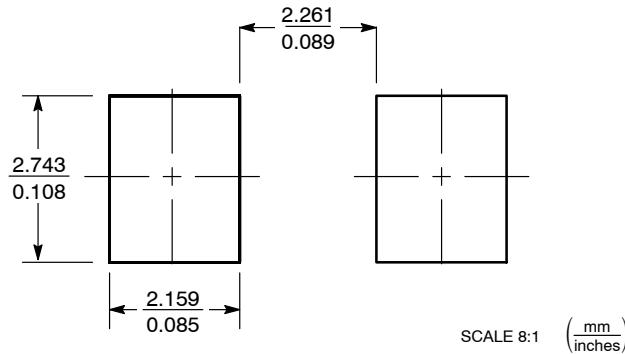

*For additional information on our Pb-Free strategy and soldering details, please download the ON Semiconductor Soldering and Mounting Techniques Reference Manual, SOLDERRM/D.

ON Semiconductor and are registered trademarks of Semiconductor Components Industries, LLC (SCILLC). SCILLC reserves the right to make changes without further notice to any products herein. SCILLC makes no warranty, representation or guarantee regarding the suitability of its products for any particular purpose, nor does SCILLC assume any liability arising out of the application or use of any product or circuit, and specifically disclaims any and all liability, including without limitation special, consequential or incidental damages. "Typical" parameters which may be provided in SCILLC data sheets and/or specifications can and do vary in different applications and actual performance may vary over time. All operating parameters, including "Typicals" must be validated for each customer application by customer's technical experts. SCILLC does not convey any license under its patent rights nor the rights of others. SCILLC products are not designed, intended, or authorized for use as components in systems intended for surgical implant into the body, or other applications intended to support or sustain life, or for any other application in which the failure of the SCILLC product could create a situation where personal injury or death may occur. Should Buyer purchase or use SCILLC products for any such unintended or unauthorized application, Buyer shall indemnify and hold SCILLC and its officers, employees, subsidiaries, affiliates, and distributors harmless against all claims, costs, damages, and expenses, and reasonable attorney fees arising out of, directly or indirectly, any claim of personal injury or death associated with such unintended or unauthorized use, even if such claim alleges that SCILLC was negligent regarding the design or manufacture of the part. SCILLC is an Equal Opportunity/Affirmative Action Employer. This literature is subject to all applicable copyright laws and is not for resale in any manner.

PUBLICATION ORDERING INFORMATION

LITERATURE FULFILLMENT:
Literature Distribution Center for ON Semiconductor
P.O. Box 5163, Denver, Colorado 80217 USA
Phone: 303-675-2175 or 800-344-3860 Toll Free USA/Canada
Fax: 303-675-2176 or 800-344-3867 Toll Free USA/Canada
Email: orderlit@onsemi.com

N. American Technical Support: 800-282-9855 Toll Free
USA/Canada
Europe, Middle East and Africa Technical Support:
Phone: 421 33 790 2910
Japan Customer Focus Center
Phone: 81-3-5817-1050

ON Semiconductor Website: www.onsemi.com
Order Literature: <http://www.onsemi.com/orderlit>
For additional information, please contact your local Sales Representative

1SMB5913BT3/D