

## Electrical Characteristics (at TA = 25°C unless otherwise noted)

Part Number	Marking Code	Zener Voltage	Test Current	Zener Impedance			Leakage Current		Surge Current
		Vz@IzT	IzT	ZzT @ IzT	ZzK @ IzK	IzK	IR	VR	I <sub>surge</sub>
		Volts	mA	oHMs	oHMs	mA	uA	Volts	mA
CZRA4728-G	Z3V3	3.3	76	10	400	1.0	100	1.0	1380
CZRA4729-G	Z3V6	3.6	69	10	400	1.0	100	1.0	1260
CZRA4730-G	Z3V9	3.9	64	9	400	1.0	50	1.0	1190
CZRA4731-G	Z4V3	4.3	58	9	400	1.0	10	1.0	1070
CZRA4732-G	Z4V7	4.7	53	8	500	1.0	10	1.0	970
CZRA4733-G	Z5V1	5.1	49	7	550	1.0	10	1.0	890
CZRA4734-G	Z5V6	5.6	45	5	600	1.0	10	2.0	810
CZRA4735-G	Z6V2	6.2	41	2	700	1.0	10	3.0	730
CZRA4736-G	Z6V8	6.8	37	3.5	700	1.0	10	4.0	660
CZRA4737-G	Z7V5	7.5	34	4	700	0.5	10	5.0	605
CZRA4738-G	Z8V2	8.2	31	4.5	700	0.5	10	6.0	550
CZRA4739-G	Z9V1	9.1	28	5	700	0.5	10	7.0	500
CZRA4740-G	Z10	10	25	7	700	0.25	10	7.6	454
CZRA4741-G	Z11	11	23	8	700	0.25	5	8.4	414
CZRA4742-G	Z12	12	21	9	700	0.25	5	9.1	380
CZRA4743-G	Z13	13	19	10	700	0.25	5	9.9	344
CZRA4744-G	Z15	15	17	14	700	0.25	5	11.4	304
CZRA4745-G	Z16	16	15.5	16	700	0.25	5	12.2	285
CZRA4746-G	Z18	18	14	20	750	0.25	5	13.7	250
CZRA4747-G	Z20	20	12.5	22	750	0.25	5	15.2	225
CZRA4748-G	Z22	22	11.5	23	750	0.25	5	16.7	205
CZRA4749-G	Z24	24	10.5	25	750	0.25	5	18.2	190
CZRA4750-G	Z27	27	9.5	35	750	0.25	5	20.6	170
CZRA4751-G	Z30	30	8.5	40	1000	0.25	5	22.8	150
CZRA4752-G	Z33	33	7.5	45	1000	0.25	5	25.1	135
CZRA4753-G	Z36	36	7.0	50	1000	0.25	5	27.4	125
CZRA4754-G	Z39	39	6.5	60	1000	0.25	5	29.7	115
CZRA4755-G	Z43	43	6.0	70	1500	0.25	5	32.7	110

## Electrical Characteristics ( at $T_A = 25^\circ\text{C}$ unless otherwise noted)

Part Number	Marking Code	Zener Voltage	Test Current	Zener Impedance			Leakage Current		Surge Current
		$V_Z @ I_{ZT}$	$I_{ZT}$	$Z_{ZT} @ I_{ZT}$	$Z_{ZK} @ I_{ZK}$	$I_{ZK}$	$I_R$	$V_R$	$I_{surge}$
		Volts	mA	( $\Omega$ )Max	( $\Omega$ )Max	mA	( $\mu\text{A}$ )Max	Volts	mA
CZRA4756-G	Z47	47	5.5	80	1500	0.25	5	35.8	95
CZRA4757-G	Z51	51	5.0	95	1500	0.25	5	38.8	90
CZRA4758-G	Z56	56	4.5	110	2000	0.25	5	42.6	80
CZRA4759-G	Z62	62	4.0	125	2000	0.25	5	47.1	70
CZRA4760-G	Z68	68	3.7	150	2000	0.25	5	51.7	65
CZRA4761-G	Z75	75	3.3	175	2000	0.25	5	56.0	60
CZRA4762-G	Z82	82	3.0	200	3000	0.25	5	62.2	55
CZRA4763-G	Z91	91	2.8	250	3000	0.25	5	69.2	50
CZRA4764-G	Z100	100	2.5	350	3000	0.25	5	76.0	45

Note: 5% tolerance of Zener voltage.

## RATING AND CHARACTERISTIC CURVES (ACZRA4728-G Thru. ACZRA4764-G)

Fig.1 - Max. Continuous Power Derating

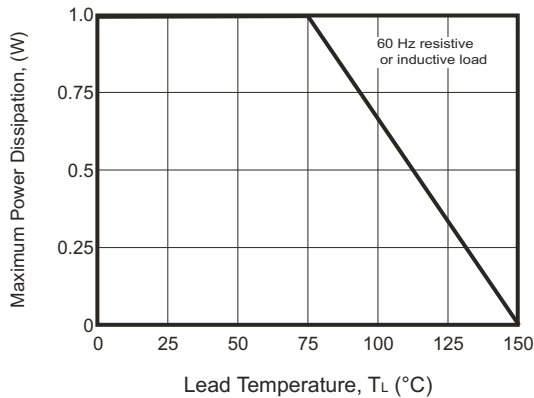
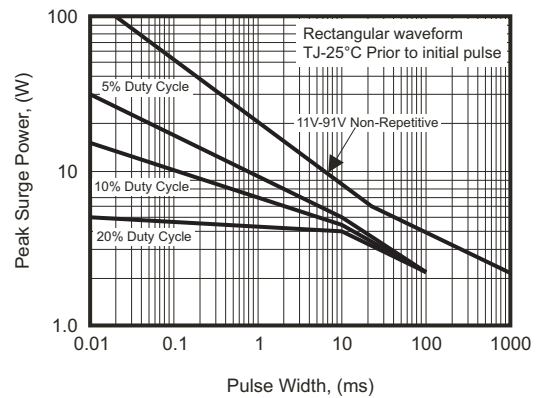

Fig.2 - Maximum surge power



## RATING AND CHARACTERISTIC CURVES ( CZRA4728-G Thru. CZRA4764-G)

FIG 3A. Range for Units to 12 Volts

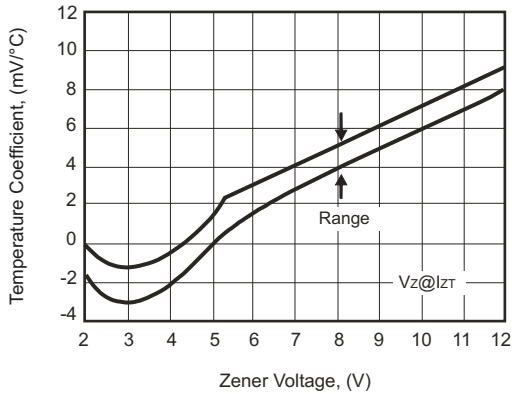

FIG 3B. Range for Units 12 to 100 Volts

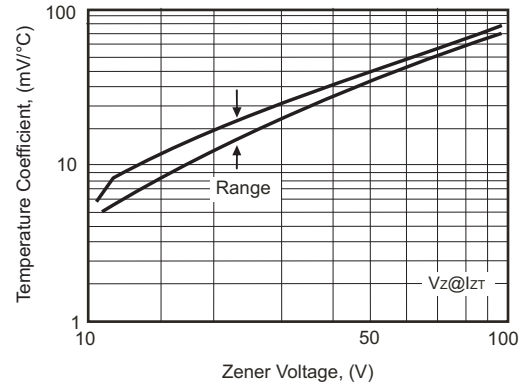

FIG 4. Temperature Coefficients (-55°C to +150°C temperature change ; 90% of the units are in the ranges indicated.)

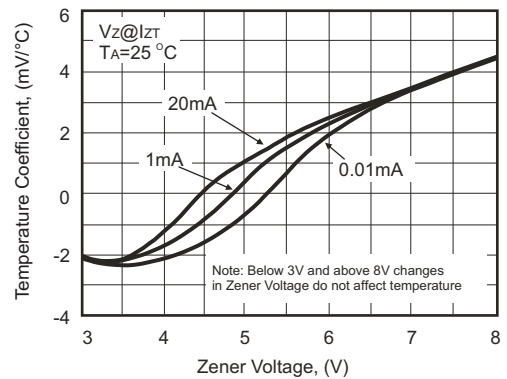
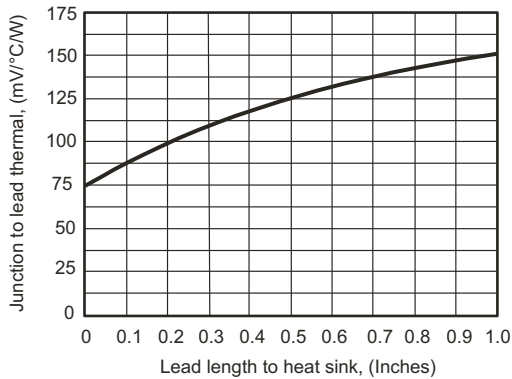

FIG 5. Typical Thermal Resistance Versus Lead

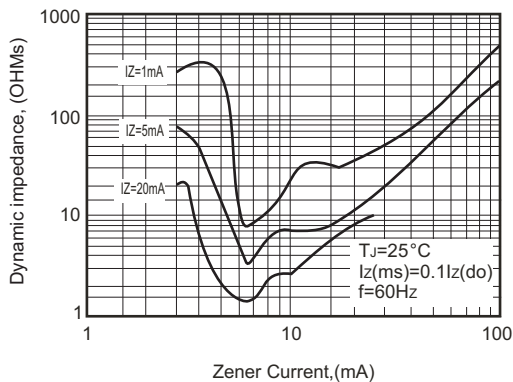
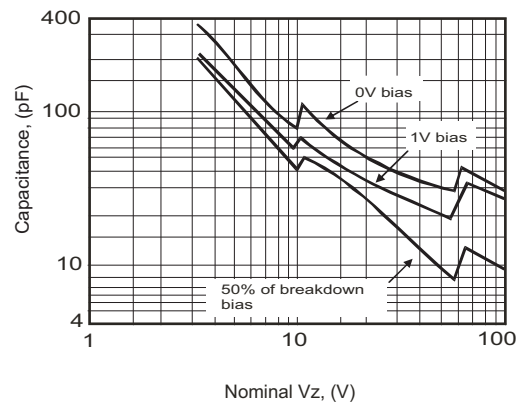
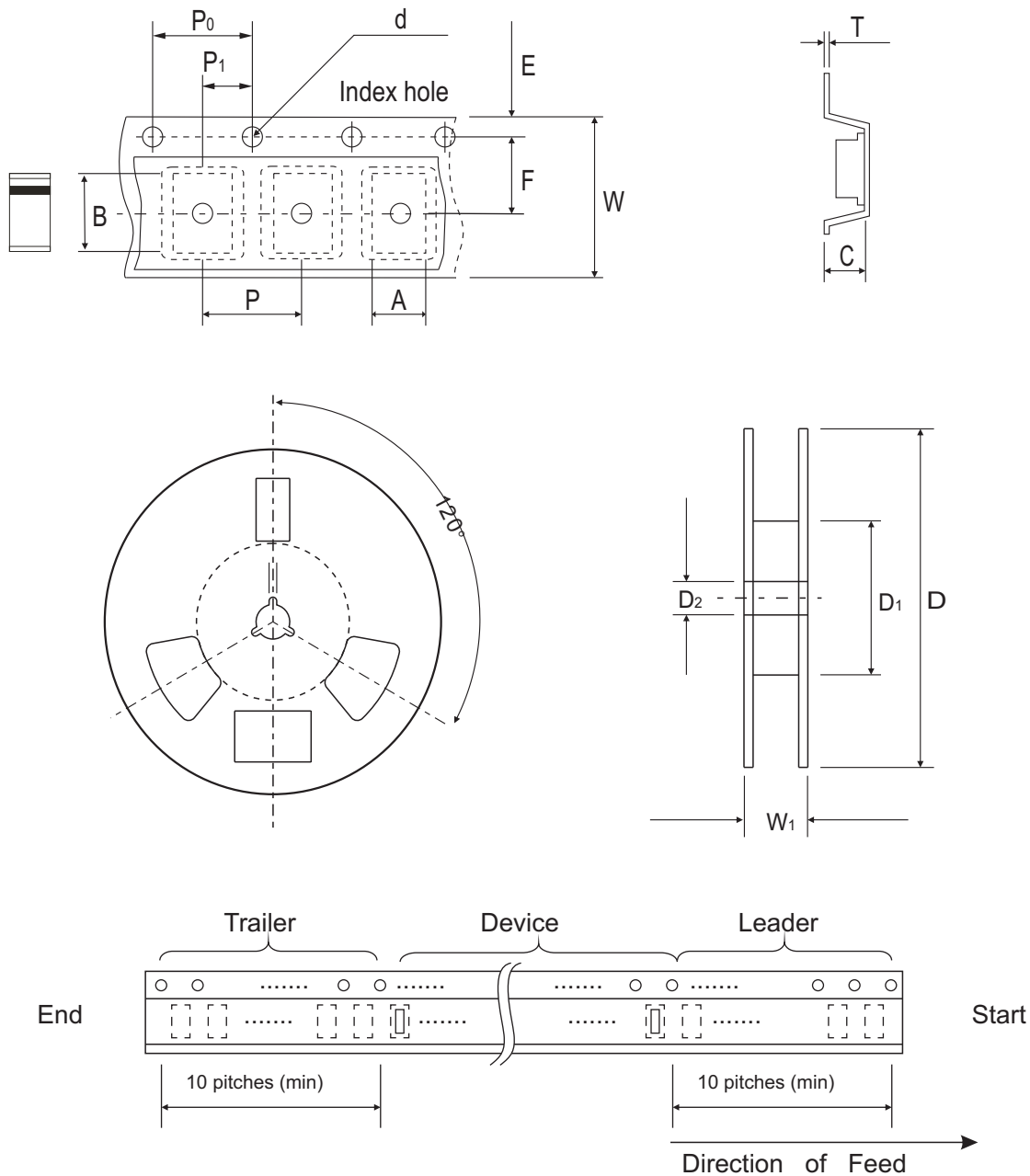

FIG 6. Effect of Zener Current



## Reel Taping Specification



DO-214AC (SMA)	SYMBOL	A	B	C	d	D	D1	D2
	(mm)	2.80 ± 0.10	5.00 ± 0.10	1.90 ± 0.10	1.50 ± 0.10	178.0 ± 2.00	62.0 MIN.	13.00 ± 0.50
	(inch)	0.110 ± 0.004	0.200 ± 0.004	0.075 ± 0.004	0.059 ± 0.004	7.008 ± 0.079	2.441 MIN.	0.512 ± 0.020

DO-214AC (SMA)	SYMBOL	E	F	P	P0	P1	W	W1
	(mm)	1.75 ± 0.10	5.50 ± 0.10	4.00 ± 0.10	4.00 ± 0.10	2.00 ± 0.10	12.00 ± 0.30	18.00 ± 1.00
	(inch)	0.069 ± 0.004	0.216 ± 0.004	0.157 ± 0.004	0.157 ± 0.004	0.079 ± 0.004	0.472 ± 0.012	0.709 ± 0.039

Company reserves the right to improve product design , functions and reliability without notice.

REV:E

## Pinning information

Pin	Simplified outline	Symbol
PIN 1 Cathode PIN 2 Anode		

## Marking Code

Part Number	Marking Code
CZRA4728-G ~ CZRA4764-G	XXXX



Product type marking code (see page.2~3)

## Suggested PAD Layout

SIZE	DO-214AC (SMA)	
	(mm)	(inch)
A	3.80	0.150
B	1.60	0.063
C	2.80	0.110
D	5.40	0.213
E	2.20	0.087

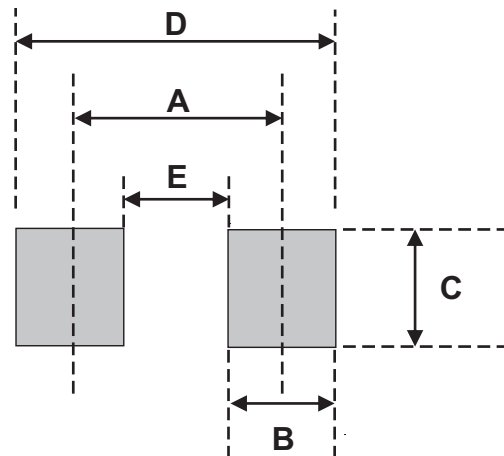

## Standard Packaging

Case Type	REEL PACK	
	REEL ( pcs )	Reel Size (inch)
DO-214AC (SMA)	2,000	7