

LT1963 Series

ABSOLUTE MAXIMUM RATINGS (Note 1)

IN Pin Voltage	±20V	SHDN Pin Voltage	±20V
OUT Pin Voltage	±20V	Output Short-Circuit Duration	Indefinite
Input to Output Differential Voltage (Note 2)	±20V	Operating Junction Temperature Range	–40°C to 125°C
SENSE Pin Voltage	±20V	Storage Temperature Range	–65°C to 150°C
ADJ Pin Voltage	±7V	Lead Temperature (Soldering, 10 sec)	300°C

PACKAGE/ORDER INFORMATION

<p>FRONT VIEW</p> <p>Q PACKAGE 5-LEAD PLASTIC DD</p> <p>*PIN 5 = SENSE FOR LT1963-1.5/LT1963-1.8/ LT1963-2.5/LT1963-3.3 = ADJ FOR LT1963 $T_{JMAX} = 150^{\circ}\text{C}$, $\theta_{JA} = 30^{\circ}\text{C/W}$</p>	<p>FRONT VIEW</p> <p>T PACKAGE 5-LEAD PLASTIC TO-220</p> <p>*PIN 5 = SENSE FOR LT1963-1.5/LT1963-1.8/ LT1963-2.5/LT1963-3.3 = ADJ FOR LT1963 $T_{JMAX} = 150^{\circ}\text{C}$, $\theta_{JA} = 50^{\circ}\text{C/W}$</p>	<p>TOP VIEW</p> <p>FE PACKAGE 16-LEAD PLASTIC TSSOP EXPOSED PAD (PIN 17) IS GND. MUST BE SOLDERED TO THE PCB. $T_{JMAX} = 150^{\circ}\text{C}$, $\theta_{JA} = 38^{\circ}\text{C/W}$</p> <p>*PIN 6 = SENSE FOR LT1963-1.5/ LT1963-1.8/LT1963-2.5/ LT1963-3.3 = ADJ FOR LT1963</p>	
ORDER PART NUMBER	ORDER PART NUMBER	ORDER PART NUMBER	FE PART MARKING
LT1963EQ LT1963EQ-1.5 LT1963EQ-1.8 LT1963EQ-2.5 LT1963EQ-3.3	LT1963ET LT1963ET-1.5 LT1963ET-1.8 LT1963ET-2.5 LT1963ET-3.3	LT1963EFE LT1963EFE-1.5 LT1963EFE-1.8 LT1963EFE-2.5 LT1963EFE-3.3	1963EFE 1963EFE15 1963EFE18 1963EFE25 1963EFE33
<p>FRONT VIEW</p> <p>ST PACKAGE 3-LEAD PLASTIC SOT-223 $T_{JMAX} = 150^{\circ}\text{C}$, $\theta_{JA} = 50^{\circ}\text{C/W}$</p>		<p>TOP VIEW</p> <p>S8 PACKAGE 8-LEAD PLASTIC SO</p> <p>*PIN 2 = SENSE FOR LT1963-1.5/LT1963-1.8/ LT1963-2.5/LT1963-3.3 = ADJ FOR LT1963 $T_{JMAX} = 150^{\circ}\text{C}$, $\theta_{JA} = 70^{\circ}\text{C/W}$</p>	
ORDER PART NUMBER	ST PART MARKING	ORDER PART NUMBER	S8 PART MARKING
LT1963EST-1.5 LT1963EST-1.8 LT1963EST-2.5 LT1963EST-3.3	196315 196318 196325 196333	LT1963ES8 LT1963ES8-1.5 LT1963ES8-1.8 LT1963ES8-2.5 LT1963ES8-3.3	1963 196315 196318 196325 196333
<p>Order Options Tape and Reel: Add #TR Lead Free: Add #PBF Lead Free Tape and Reel: Add #TRPBF Lead Free Part Marking: http://www.linear.com/leadfree/</p>			

Consult LTC Marketing for parts specified with wider operating temperature ranges.

1963fc

ELECTRICAL CHARACTERISTICS

The ● denotes specifications which apply over the full operating temperature range, otherwise specifications are $T_A = 25^\circ\text{C}$. (Note 3)

PARAMETER	CONDITIONS		MIN	TYP	MAX	UNITS	
Minimum Input Voltage (Notes 4,12)	$I_{LOAD} = 0.5\text{A}$			1.9		V	
	$I_{LOAD} = 1.5\text{A}$	$2.5\text{V} < V_{IN} < 20\text{V}$, $1\text{mA} < I_{LOAD} < 1.5\text{A}$	●	2.1	2.5	V	
Regulated Output Voltage (Note 5)	LT1963-1.5	$V_{IN} = 2.21\text{V}$, $I_{LOAD} = 1\text{mA}$ $2.5\text{V} < V_{IN} < 20\text{V}$, $1\text{mA} < I_{LOAD} < 1.5\text{A}$	●	1.477	1.500	1.523	V
			●	1.447	1.500	1.545	V
	LT1963-1.8	$V_{IN} = 2.3\text{V}$, $I_{LOAD} = 1\text{mA}$ $2.8\text{V} < V_{IN} < 20\text{V}$, $1\text{mA} < I_{LOAD} < 1.5\text{A}$	●	1.773	1.800	1.827	V
			●	1.737	1.800	1.854	V
	LT1963-2.5	$V_{IN} = 3\text{V}$, $I_{LOAD} = 1\text{mA}$ $3.5\text{V} < V_{IN} < 20\text{V}$, $1\text{mA} < I_{LOAD} < 1.5\text{A}$	●	2.462	2.500	2.538	V
			●	2.412	2.500	2.575	V
	LT1963-3.3	$V_{IN} = 3.8\text{V}$, $I_{LOAD} = 1\text{mA}$ $4.3\text{V} < V_{IN} < 20\text{V}$, $1\text{mA} < I_{LOAD} < 1.5\text{A}$	●	3.250	3.300	3.350	V
			●	3.200	3.300	3.400	V
ADJ Pin Voltage (Notes 4, 5)	LT1963	$V_{IN} = 2.21\text{V}$, $I_{LOAD} = 1\text{mA}$ $2.5\text{V} < V_{IN} < 20\text{V}$, $1\text{mA} < I_{LOAD} < 1.5\text{A}$	●	1.192	1.210	1.228	V
			●	1.174	1.210	1.246	V
Line Regulation	LT1963-1.5	$\Delta V_{IN} = 2.21\text{V}$ to 20V , $I_{LOAD} = 1\text{mA}$	●		2.0	10	mV
	LT1963-1.8	$\Delta V_{IN} = 2.3\text{V}$ to 20V , $I_{LOAD} = 1\text{mA}$	●		2.5	10	mV
	LT1963-2.5	$\Delta V_{IN} = 3\text{V}$ to 20V , $I_{LOAD} = 1\text{mA}$	●		3.0	10	mV
	LT1963-3.3	$\Delta V_{IN} = 3.8\text{V}$ to 20V , $I_{LOAD} = 1\text{mA}$	●		3.5	10	mV
	LT1963 (Note 4)	$\Delta V_{IN} = 2.21\text{V}$ to 20V , $I_{LOAD} = 1\text{mA}$	●		1.5	10	mV
Load Regulation	LT1963-1.5	$V_{IN} = 2.5\text{V}$, $\Delta I_{LOAD} = 1\text{mA}$ to 1.5A $V_{IN} = 2.5\text{V}$, $\Delta I_{LOAD} = 1\text{mA}$ to 1.5A	●		2	9	mV
			●			18	mV
	LT1963-1.8	$V_{IN} = 2.8\text{V}$, $\Delta I_{LOAD} = 1\text{mA}$ to 1.5A $V_{IN} = 2.8\text{V}$, $\Delta I_{LOAD} = 1\text{mA}$ to 1.5A	●		2	10	mV
			●			20	mV
	LT1963-2.5	$V_{IN} = 3.5\text{V}$, $\Delta I_{LOAD} = 1\text{mA}$ to 1.5A $V_{IN} = 3.5\text{V}$, $\Delta I_{LOAD} = 1\text{mA}$ to 1.5A	●		2.5	15	mV
		●			30	mV	
	LT1963-3.3	$V_{IN} = 4.3\text{V}$, $\Delta I_{LOAD} = 1\text{mA}$ to 1.5A $V_{IN} = 4.3\text{V}$, $\Delta I_{LOAD} = 1\text{mA}$ to 1.5A	●		3	20	mV
			●			35	mV
LT1963 (Note 4)	$V_{IN} = 2.5\text{V}$, $\Delta I_{LOAD} = 1\text{mA}$ to 1.5A $V_{IN} = 2.5\text{V}$, $\Delta I_{LOAD} = 1\text{mA}$ to 1.5A	●		2	8	mV	
		●			15	mV	
Dropout Voltage $V_{IN} = V_{OUT(NOMINAL)}$ (Notes 6, 7, 12)	$I_{LOAD} = 1\text{mA}$		●		0.02	0.06	V
	$I_{LOAD} = 1\text{mA}$		●			0.10	V
	$I_{LOAD} = 100\text{mA}$		●		0.10	0.17	V
	$I_{LOAD} = 100\text{mA}$		●			0.22	V
	$I_{LOAD} = 500\text{mA}$		●		0.19	0.27	V
	$I_{LOAD} = 500\text{mA}$		●			0.35	V
	$I_{LOAD} = 1.5\text{A}$		●		0.34	0.45	V
	$I_{LOAD} = 1.5\text{A}$		●			0.55	V
GND Pin Current $V_{IN} = V_{OUT(NOMINAL)} + 1\text{V}$ (Notes 6, 8)	$I_{LOAD} = 0\text{mA}$		●		1.0	1.5	mA
	$I_{LOAD} = 1\text{mA}$		●		1.1	1.6	mA
	$I_{LOAD} = 100\text{mA}$		●		3.8	5.5	mA
	$I_{LOAD} = 500\text{mA}$		●		15	25	mA
	$I_{LOAD} = 1.5\text{A}$		●		80	120	mA
Output Voltage Noise	$C_{OUT} = 10\mu\text{F}$, $I_{LOAD} = 1.5\text{A}$, $\text{BW} = 10\text{Hz}$ to 100kHz			40		μV_{RMS}	
ADJ Pin Bias Current	(Notes 4, 9)			3	10	μA	
Shutdown Threshold	$V_{OUT} = \text{Off to On}$	●		0.90	2	V	
	$V_{OUT} = \text{On to Off}$	●	0.25	0.75		V	
SHDN Pin Current (Note 10)	$V_{SHDN} = 0\text{V}$			0.01	1	μA	
	$V_{SHDN} = 20\text{V}$			3	30	μA	
Quiescent Current in Shutdown	$V_{IN} = 6\text{V}$, $V_{SHDN} = 0\text{V}$			0.01	1	μA	
Ripple Rejection	$V_{IN} - V_{OUT} = 1.5\text{V}$ (Avg), $V_{RIPPLE} = 0.5\text{V}_{P-P}$, $f_{RIPPLE} = 120\text{Hz}$, $I_{LOAD} = 0.75\text{A}$		55	63		dB	

ELECTRICAL CHARACTERISTICS

The ● denotes specifications which apply over the full operating temperature range, otherwise specifications are $T_A = 25^\circ\text{C}$. (Note 3)

PARAMETER	CONDITIONS	MIN	TYP	MAX	UNITS
Current Limit	$V_{IN} = 7V, V_{OUT} = 0V$ $V_{IN} = V_{OUT(NOMINAL)} + 1V, \Delta V_{OUT} = -0.1V$	● 1.6	2		A A
Input Reverse Leakage Current (Note 13)	Q, T, S8 Packages $V_{IN} = -20V, V_{OUT} = 0V$ ST Package $V_{IN} = -20V, V_{OUT} = 0V$	●		1 2	mA mA
Reverse Output Current (Note 11)	LT1963-1.5 $V_{OUT} = 1.5V, V_{IN} < 1.5V$ LT1963-1.8 $V_{OUT} = 1.8V, V_{IN} < 1.8V$ LT1963-2.5 $V_{OUT} = 2.5V, V_{IN} < 2.5V$ LT1963-3.3 $V_{OUT} = 3.3V, V_{IN} < 3.3V$ LT1963 (Note 4) $V_{OUT} = 1.21V, V_{IN} < 1.21V$		600 600 600 600 300	1200 1200 1200 1200 600	μA μA μA μA μA

Note 1: Absolute Maximum Ratings are those values beyond which the life of a device may be impaired.

Note 2: Absolute maximum input to output differential voltage can not be achieved with all combinations of rated IN pin and OUT pin voltages. With the IN pin at 20V, the OUT pin may not be pulled below 0V. The total measured voltage from IN to OUT can not exceed $\pm 20V$.

Note 3: The LT1963 regulators are tested and specified under pulse load conditions such that $T_J \approx T_A$. The LT1963 is 100% tested at $T_A = 25^\circ\text{C}$. Performance at -40°C and 125°C is assured by design, characterization and correlation with statistical process controls.

Note 4: The LT1963 (adjustable version) is tested and specified for these conditions with the ADJ pin connected to the OUT pin.

Note 5: Operating conditions are limited by maximum junction temperature. The regulated output voltage specification will not apply for all possible combinations of input voltage and output current. When operating at maximum input voltage, the output current range must be limited. When operating at maximum output current, the input voltage range must be limited.

Note 6: To satisfy requirements for minimum input voltage, the LT1963 (adjustable version) is tested and specified for these conditions with an

external resistor divider (two 4.12k resistors) for an output voltage of 2.4V. The external resistor divider will add a $300\mu\text{A}$ DC load on the output.

Note 7: Dropout voltage is the minimum input to output voltage differential needed to maintain regulation at a specified output current. In dropout, the output voltage will be equal to: $V_{IN} - V_{DROPOUT}$.

Note 8: GND pin current is tested with $V_{IN} = V_{OUT(NOMINAL)} + 1V$ and a current source load. The GND pin current will decrease at higher input voltages.

Note 9: ADJ pin bias current flows into the ADJ pin.

Note 10: $\overline{\text{SHDN}}$ pin current flows into the $\overline{\text{SHDN}}$ pin.

Note 11: Reverse output current is tested with the IN pin grounded and the OUT pin forced to the rated output voltage. This current flows into the OUT pin and out the GND pin.

Note 12: For the LT1963, LT1963-1.5 and LT1963-1.8 dropout voltage will be limited by the minimum input voltage specification under some output voltage/load conditions.

Note 13: For the ST package, the input reverse leakage current increases due to the additional reverse leakage current for the $\overline{\text{SHDN}}$ pin, which is tied internally to the IN pin.

TYPICAL PERFORMANCE CHARACTERISTICS

Typical Dropout Voltage

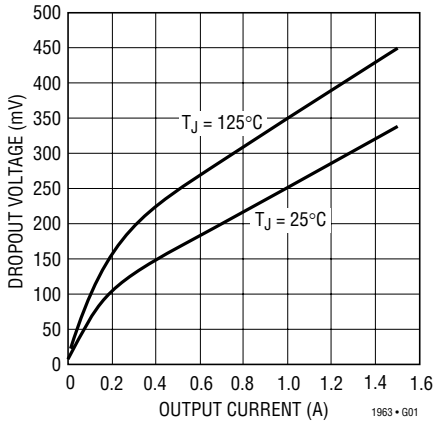

Guaranteed Dropout Voltage

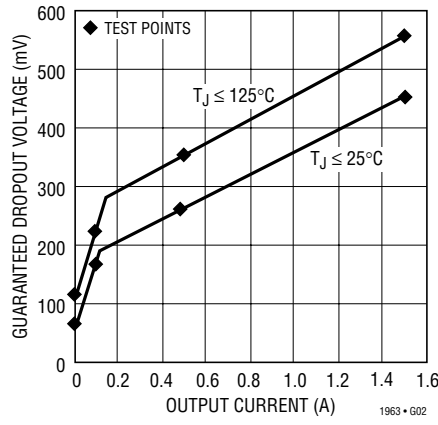

Dropout Voltage

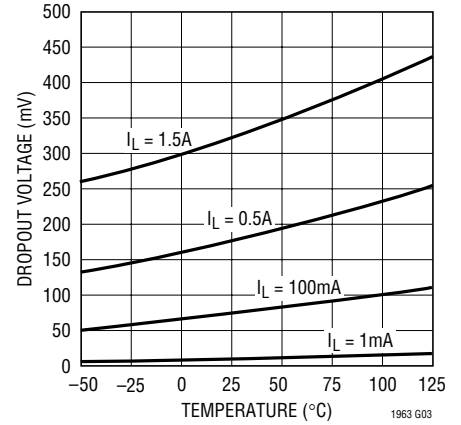

Quiescent Current

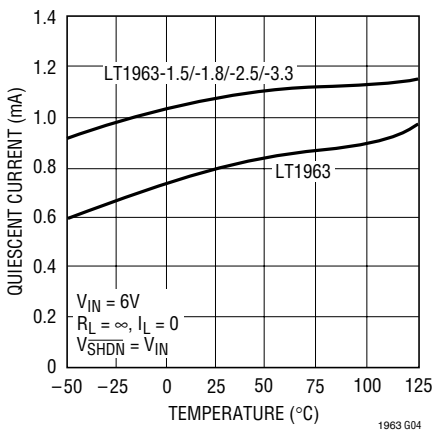

LT1963-1.5 Output Voltage

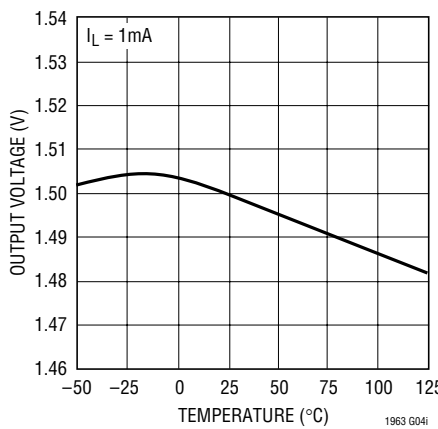

LT1963-1.8 Output Voltage

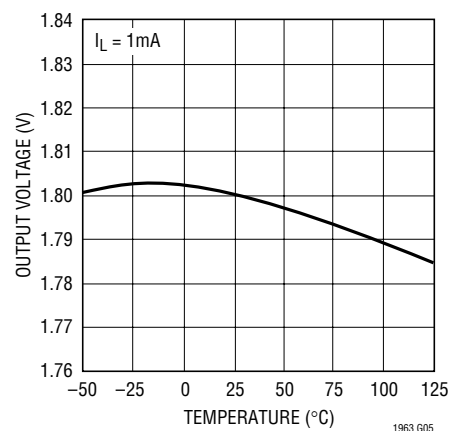

LT1963-2.5 Output Voltage

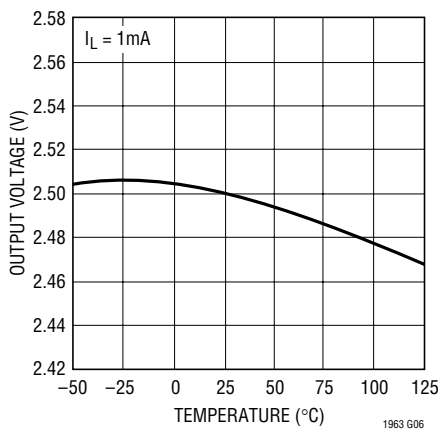

LT1963-3.3 Output Voltage

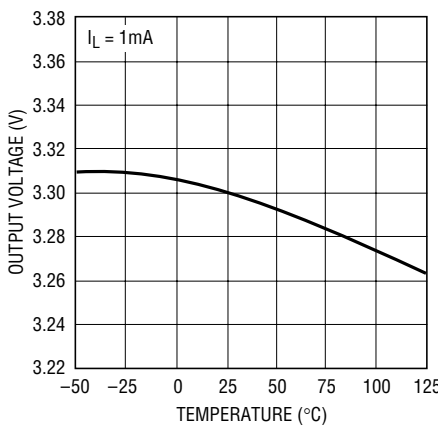

LT1963 ADJ Pin Voltage

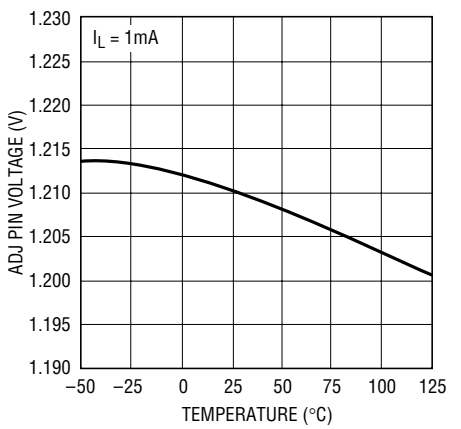

TYPICAL PERFORMANCE CHARACTERISTICS

LT1963-1.5 Quiescent Current

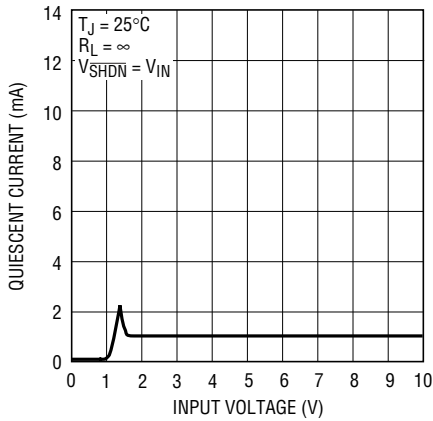

1963 G08

LT1963-1.8 Quiescent Current

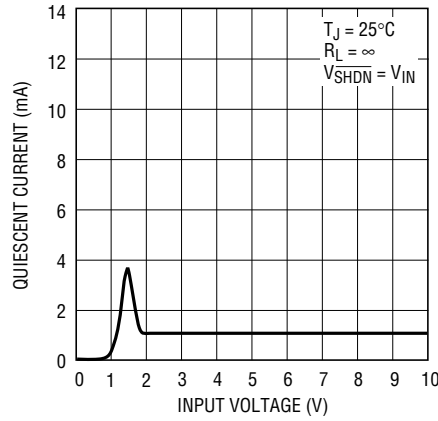

1963 G09

LT1963-2.5 Quiescent Current

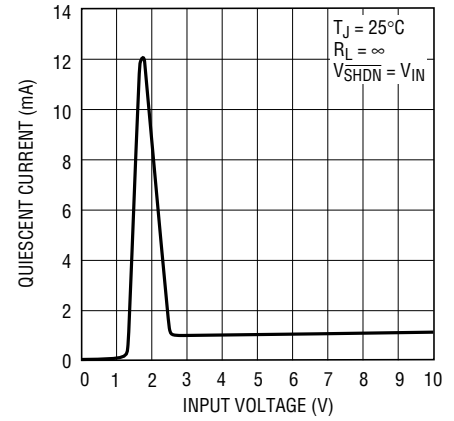

1963 G10

LT1963-3.3 Quiescent Current

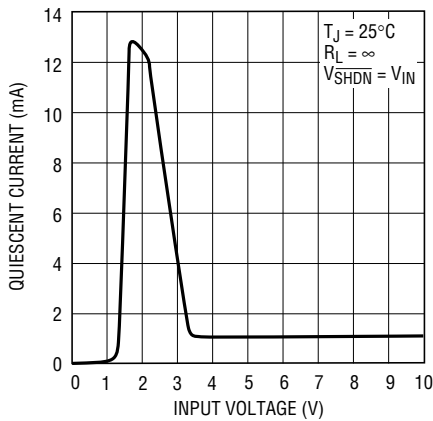

1963 G11

LT1963 Quiescent Current

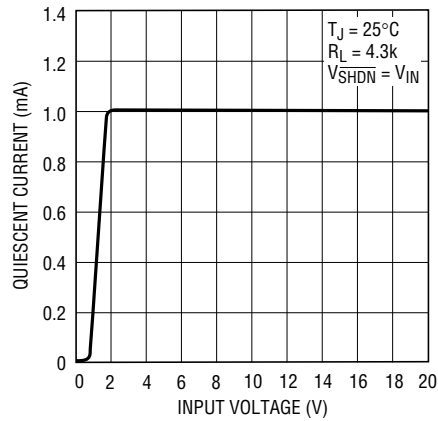

1963 G12

LT1963-1.5 GND Pin Current

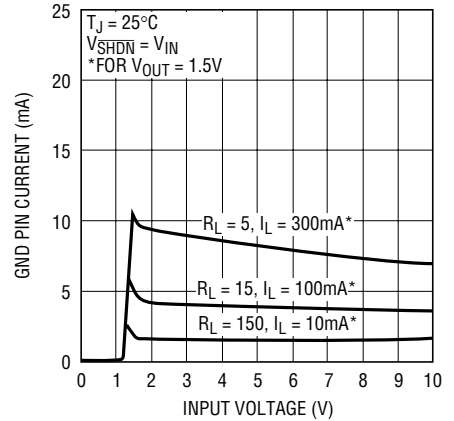

LT1963 G12i

LT1963-1.8 GND Pin Current

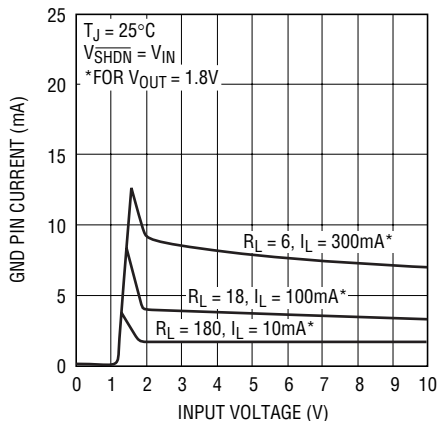

1963 G13

LT1963-2.5 GND Pin Current

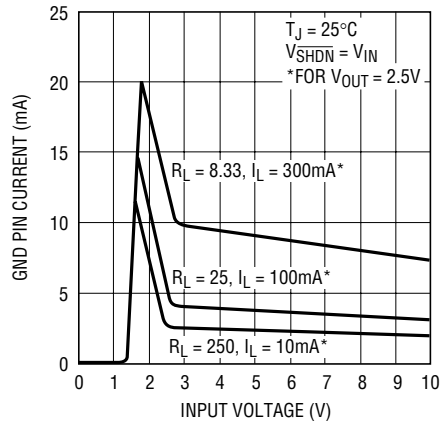

1963 G14

LT1963-3.3 GND Pin Current

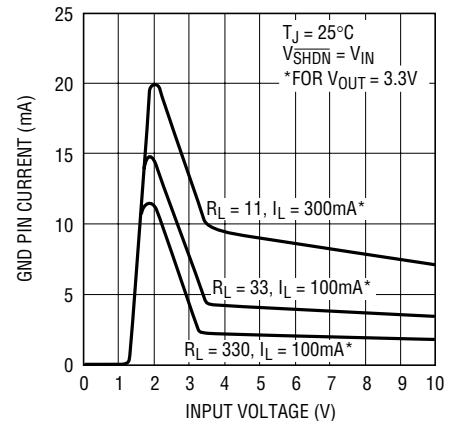

1963 G15

TYPICAL PERFORMANCE CHARACTERISTICS

LT1963 GND Pin Current

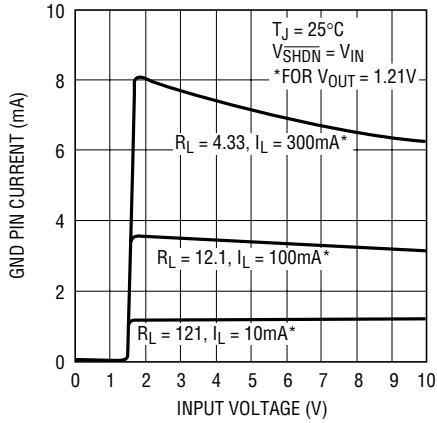

1963 G16

LT1963-1.5 GND Pin Current

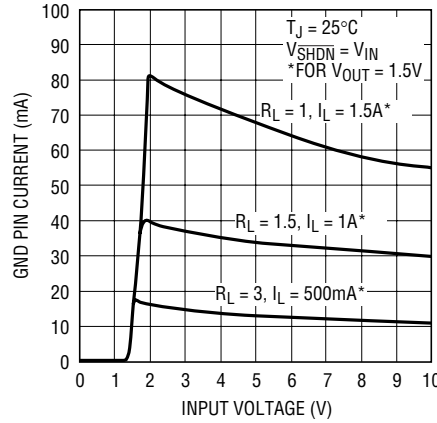

1963 G16I

LT1963-1.8 GND Pin Current

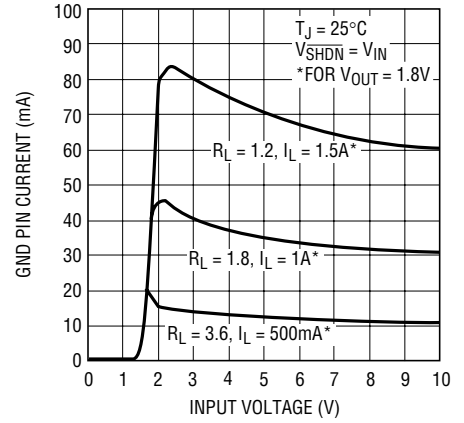

1963 G17

LT1963-2.5 GND Pin Current

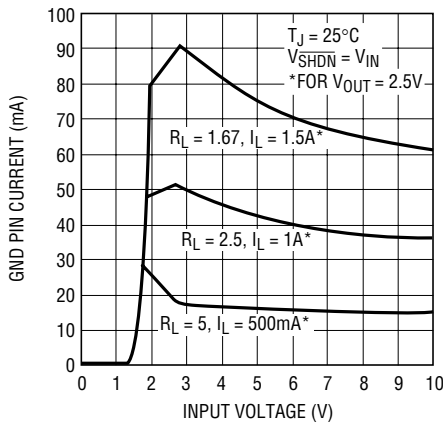

1963 G18

LT1963-3.3 GND Pin Current

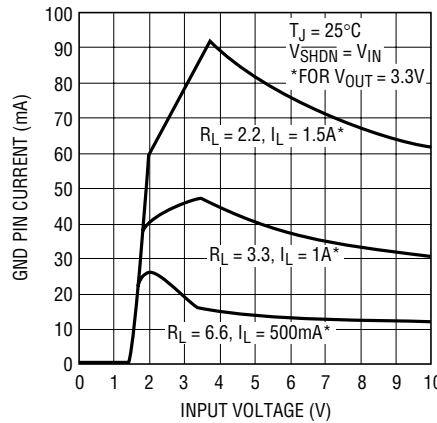

1963 G19

LT1963 GND Pin Current

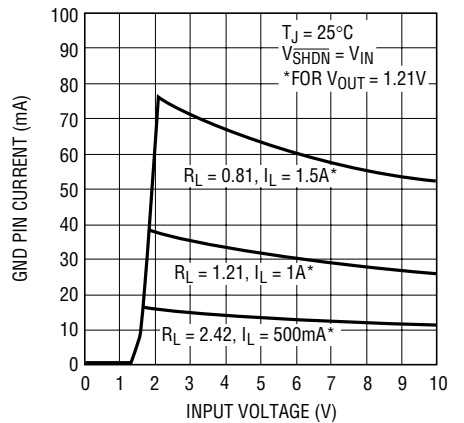

1963 G20

GND Pin Current vs I_{LOAD}

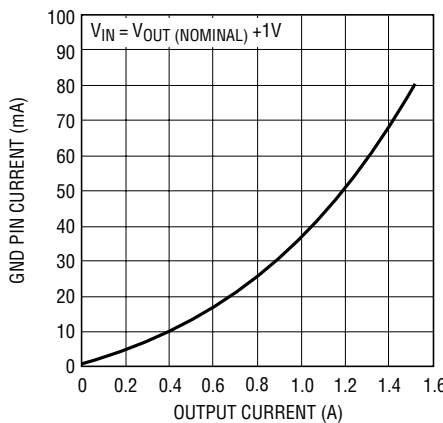

1963 G21

SHDN Pin Threshold (On-to-Off)

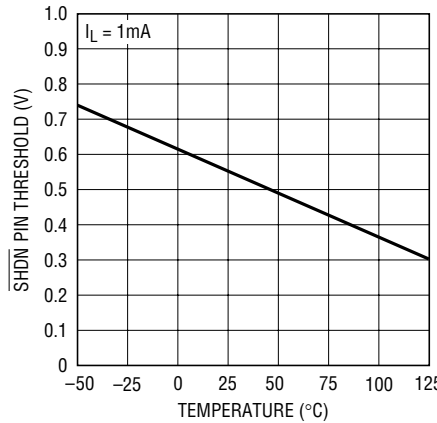

1963 G22

SHDN Pin Threshold (Off-to-On)

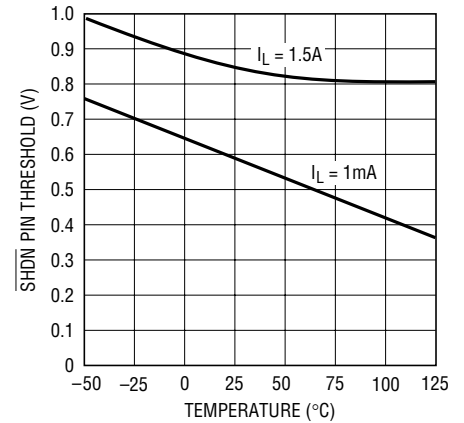

1963 G23

TYPICAL PERFORMANCE CHARACTERISTICS

SHDN Pin Input Current

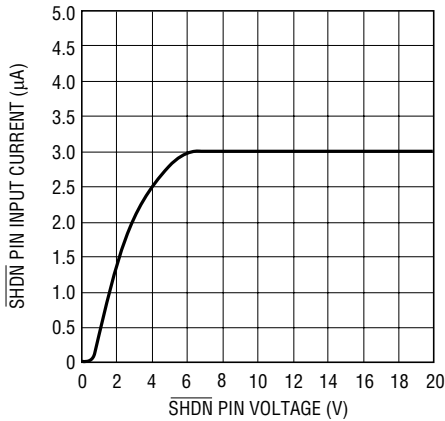

1963 G24

SHDN Pin Input Current

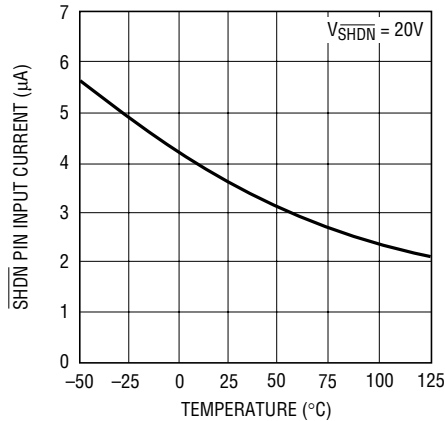

1963 G25

ADJ Pin Bias Current

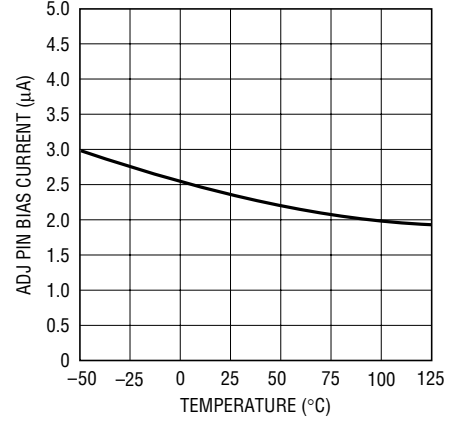

1963 G26

Current Limit

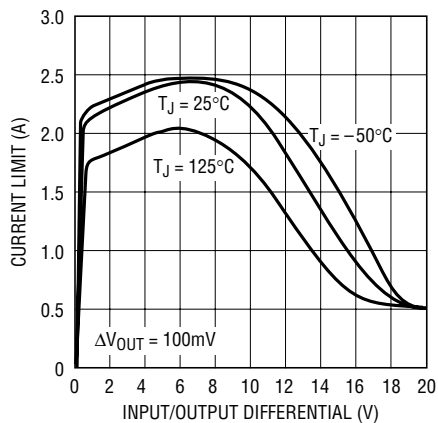

1963 G27

Current Limit

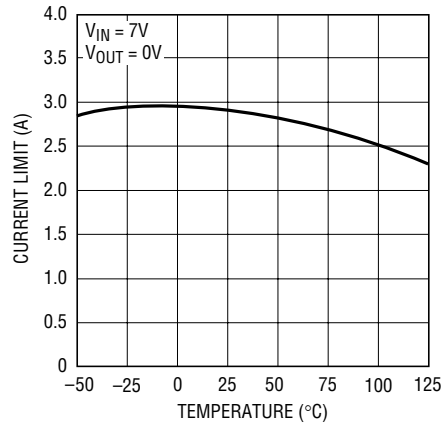

1963 G28

Reverse Output Current

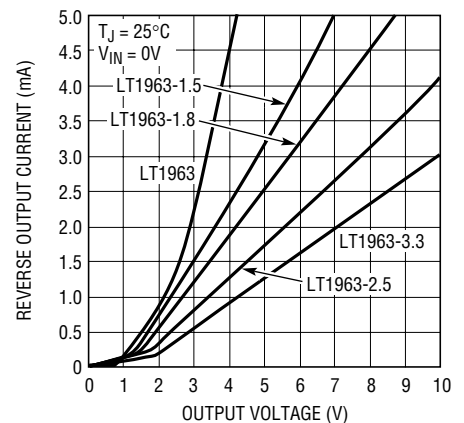

CURRENT FLOWS INTO OUTPUT PIN
 $V_{OUT} = V_{ADJ}$ (LT1963)
 $V_{OUT} = V_{FB}$ (LT1963-1.5/-1.8/-2.5/-3.3)

1963 G29

Reverse Output Current

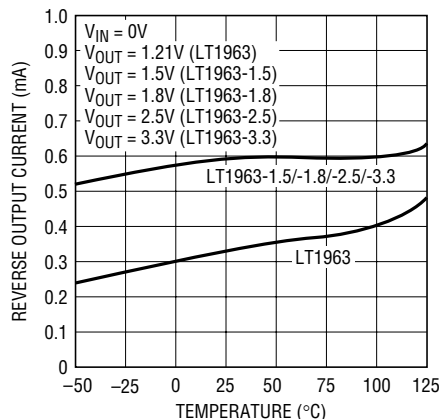

1963 G30

Ripple Rejection

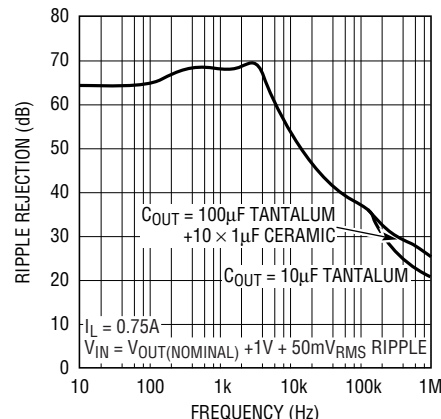

1963 G31

Ripple Rejection

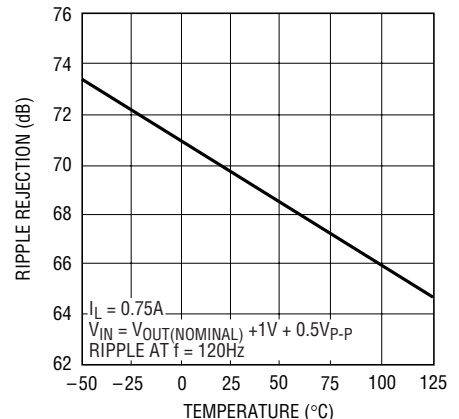

1963 G32

TYPICAL PERFORMANCE CHARACTERISTICS

LT1963 Minimum Input Voltage

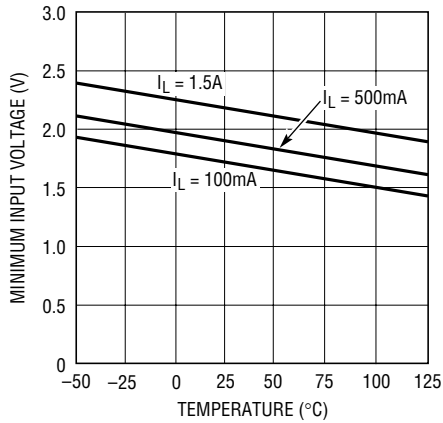

1963 G33

Load Regulation

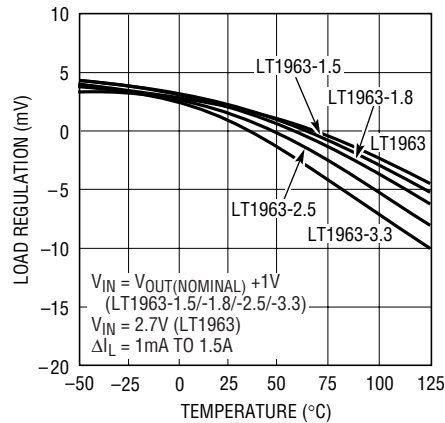

1963 G34

Output Noise Spectral Density

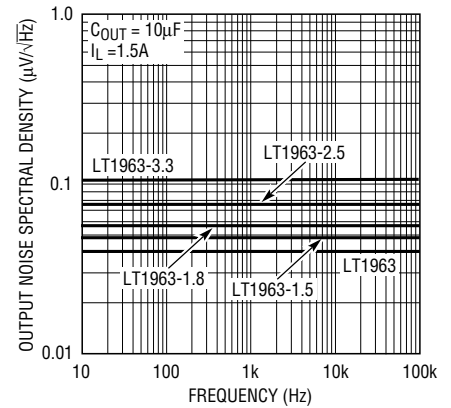

1963 G35

RMS Output Noise vs Load Current (10Hz to 100kHz)

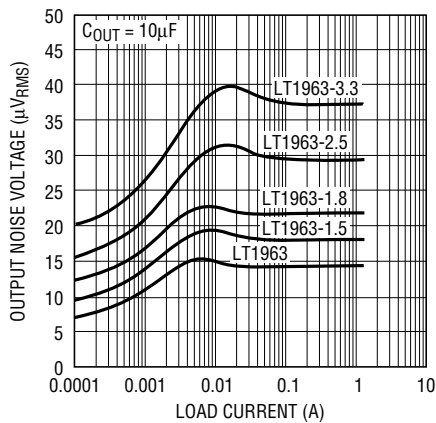

1063 G36

LT1963-3.3 10Hz to 100kHz Output Noise

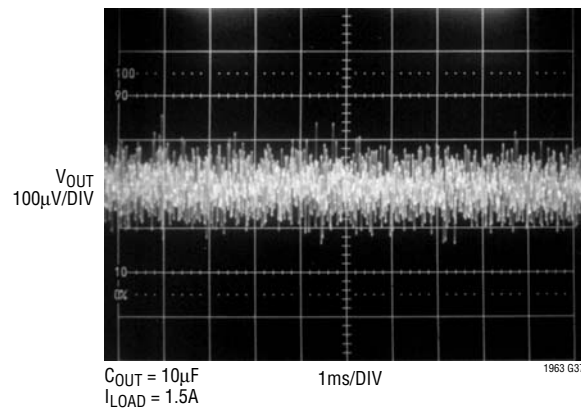

1963 G37

LT1963-3.3 Transient Response

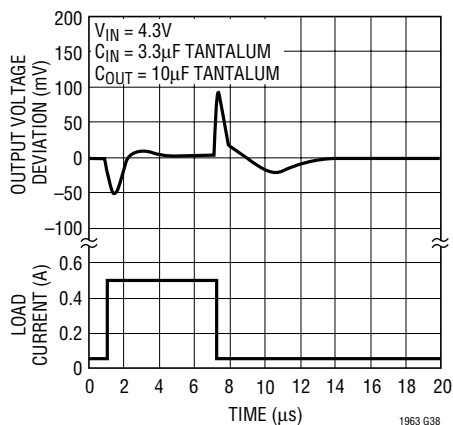

1963 G38

LT1963-3.3 Transient Response

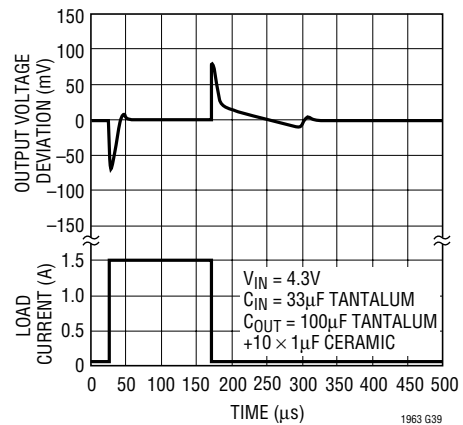

1963 G39

PIN FUNCTIONS

OUT: Output. The output supplies power to the load. A minimum output capacitor of $10\mu\text{F}$ is required to prevent oscillations. Larger output capacitors will be required for applications with large transient loads to limit peak voltage transients. See the Applications Information section for more information on output capacitance and reverse output characteristics.

SENSE: Sense. For fixed voltage versions of the LT1963 (LT1963-1.5/LT1963-1.8/LT1963-2.5/LT1963-3.3), the SENSE pin is the input to the error amplifier. Optimum regulation will be obtained at the point where the SENSE pin is connected to the OUT pin of the regulator. In critical applications, small voltage drops are caused by the resistance (R_P) of PC traces between the regulator and the load. These may be eliminated by connecting the SENSE pin to the output at the load as shown in Figure 1 (Kelvin Sense Connection). Note that the voltage drop across the external PC traces will add to the dropout voltage of the regulator. The SENSE pin bias current is $600\mu\text{A}$ at the nominal rated output voltage. The SENSE pin can be pulled below ground (as in a dual supply system where the regulator load is returned to a negative supply) and still allow the device to start and operate.

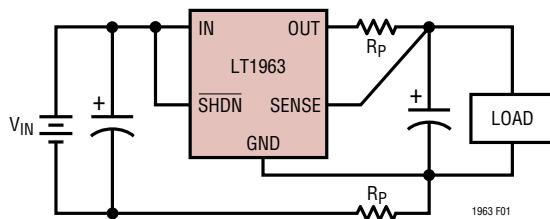

Figure 1. Kelvin Sense Connection

ADJ: Adjust. For the adjustable LT1963, this is the input to the error amplifier. This pin is internally clamped to $\pm 7\text{V}$. It has a bias current of $3\mu\text{A}$ which flows into the pin. The ADJ pin voltage is 1.21V referenced to ground and the output voltage range is 1.21V to 20V .

SHDN: Shutdown. The $\overline{\text{SHDN}}$ pin is used to put the LT1963 regulators into a low power shutdown state. The output will be off when the SHDN pin is pulled low. The SHDN pin can be driven either by 5V logic or open-collector logic with a pull-up resistor. The pull-up resistor is required to supply the pull-up current of the open-collector gate, normally several microamperes, and the SHDN pin current, typically $3\mu\text{A}$. If unused, the SHDN pin must be connected to V_{IN} . The device will be in the low power shutdown state if the SHDN pin is not connected.

IN: Input. Power is supplied to the device through the IN pin. A bypass capacitor is required on this pin if the device is more than six inches away from the main input filter capacitor. In general, the output impedance of a battery rises with frequency, so it is advisable to include a bypass capacitor in battery-powered circuits. A bypass capacitor in the range of $1\mu\text{F}$ to $10\mu\text{F}$ is sufficient. The LT1963 regulators are designed to withstand reverse voltages on the IN pin with respect to ground and the OUT pin. In the case of a reverse input, which can happen if a battery is plugged in backwards, the device will act as if there is a diode in series with its input. There will be no reverse current flow into the regulator and no reverse voltage will appear at the load. The device will protect both itself and the load.

Exposed Pad: GND. The Exposed Pad (FE Package) is ground and must be soldered to the PCB for rated thermal performance.

APPLICATIONS INFORMATION

The LT1963 series are 1.5A low dropout regulators optimized for fast transient response. The devices are capable of supplying 1.5A at a dropout voltage of 350mV. The low operating quiescent current (1mA) drops to less than 1μA in shutdown. In addition to the low quiescent current, the LT1963 regulators incorporate several protection features which make them ideal for use in battery-powered systems. The devices are protected against both reverse input and reverse output voltages. In battery backup applications where the output can be held up by a backup battery when the input is pulled to ground, the LT1963-X acts like it has a diode in series with its output and prevents reverse current flow. Additionally, in dual supply applications where the regulator load is returned to a negative supply, the output can be pulled below ground by as much as 20V and still allow the device to start and operate.

Adjustable Operation

The adjustable version of the LT1963 has an output voltage range of 1.21V to 20V. The output voltage is set by the ratio of two external resistors as shown in Figure 2. The device servos the output to maintain the voltage at the ADJ pin at 1.21V referenced to ground. The current in R1 is then equal to 1.21V/R1 and the current in R2 is the current in R1 plus the ADJ pin bias current. The ADJ pin bias current, 3μA at 25°C, flows through R2 into the ADJ pin. The output voltage can be calculated using the formula in Figure 2. The value of R1 should be less than 4.17k to minimize errors in the output voltage caused by the ADJ pin bias current. Note that in shutdown the output is turned off and the divider current will be zero.

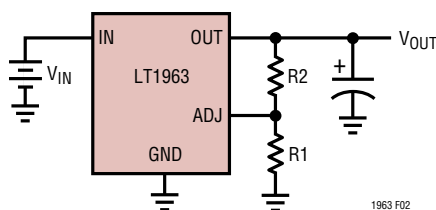

$$V_{OUT} = 1.21V \left(1 + \frac{R2}{R1} \right) + (I_{ADJ})(R2)$$

$$V_{ADJ} = 1.21V$$

$$I_{ADJ} = 3\mu A \text{ AT } 25^\circ C$$

$$\text{OUTPUT RANGE} = 1.21V \text{ TO } 20V$$

Figure 2. Adjustable Operation

The adjustable device is tested and specified with the ADJ pin tied to the OUT pin for an output voltage of 1.21V. Specifications for output voltages greater than 1.21V will be proportional to the ratio of the desired output voltage to 1.21V: $V_{OUT}/1.21V$. For example, load regulation for an output current change of 1mA to 1.5A is -3mV typical at $V_{OUT} = 1.21V$. At $V_{OUT} = 5V$, load regulation is:

$$(5V/1.21V)(-3mV) = -12.4mV$$

Output Capacitance and Transient Response

The LT1963 regulators are designed to be stable with a wide range of output capacitors. The ESR of the output capacitor affects stability, most notably with small capacitors. A minimum output capacitor of 10μF with an ESR in the range of 50mΩ to 3Ω is recommended to prevent oscillations. Larger values of output capacitance can decrease the peak deviations and provide improved transient response for larger load current changes. Bypass capacitors, used to decouple individual components powered by the LT1963, will increase the effective output capacitor value.

Extra consideration must be given to the use of ceramic capacitors. Ceramic capacitors are manufactured with a variety of dielectrics, each with different behavior across temperature and applied voltage. The most common dielectrics used are specified with EIA temperature characteristic codes of Z5U, Y5V, X5R and X7R. The Z5U and Y5V dielectrics are good for providing high capacitances in a small package, but they tend to have strong voltage and temperature coefficients as shown in Figures 2 and 3. When used with a 5V regulator, a 16V 10μF Y5V capacitor can exhibit an effective value as low as 1μF to 2μF for the DC bias voltage applied and over the operating temperature range. The X5R and X7R dielectrics result in more stable characteristics and are more suitable for use as the output capacitor. The X7R type has better stability across temperature, while the X5R is less expensive and is available in higher values. Care still must be exercised when using X5R and X7R capacitors; the X5R and X7R codes only specify operating temperature range and maximum capacitance change over temperature. Capacitance change due to DC bias with X5R and X7R capacitors is better than Y5V and Z5U capacitors, but can still be significant enough to drop capacitor values below appropriate levels. Capacitor DC bias characteristics tend to

1963f

APPLICATIONS INFORMATION

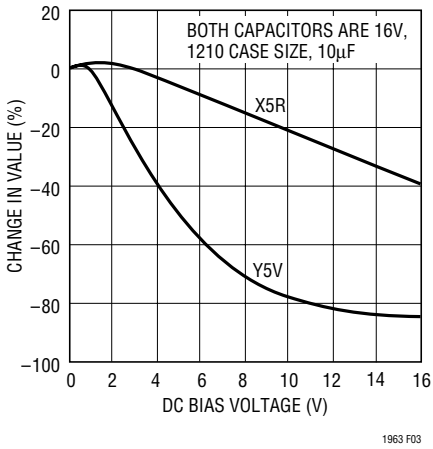

Figure 3. Ceramic Capacitor DC Bias Characteristics

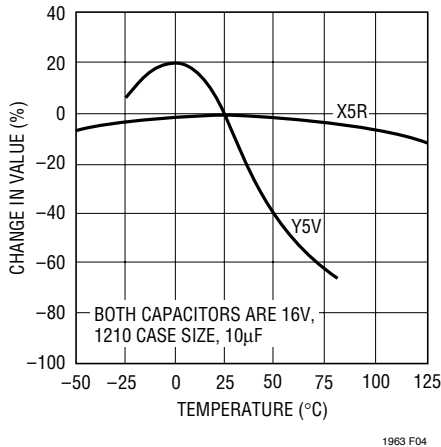

Figure 4. Ceramic Capacitor Temperature Characteristics

improve as component case size increases, but expected capacitance at operating voltage should be verified.

Voltage and temperature coefficients are not the only sources of problems. Some ceramic capacitors have a piezoelectric response. A piezoelectric device generates voltage across its terminals due to mechanical stress, similar to the way a piezoelectric accelerometer or microphone works. For a ceramic capacitor the stress can be induced by vibrations in the system or thermal transients.

Overload Recovery

Like many IC power regulators, the LT1963-X has safe operating area protection. The safe area protection decreases the current limit as input-to-output voltage increases and keeps the power transistor inside a safe

operating region for all values of input-to-output voltage. The protection is designed to provide some output current at all values of input-to-output voltage up to the device breakdown.

When power is first turned on, as the input voltage rises, the output follows the input, allowing the regulator to start up into very heavy loads. During the start-up, as the input voltage is rising, the input-to-output voltage differential is small, allowing the regulator to supply large output currents. With a high input voltage, a problem can occur wherein removal of an output short will not allow the output voltage to recover. Other regulators, such as the LT1085, also exhibit this phenomenon, so it is not unique to the LT1963-X.

The problem occurs with a heavy output load when the input voltage is high and the output voltage is low. Common situations are immediately after the removal of a short-circuit or when the shutdown pin is pulled high after the input voltage has already been turned on. The load line for such a load may intersect the output current curve at two points. If this happens, there are two stable output operating points for the regulator. With this double intersection, the input power supply may need to be cycled down to zero and brought up again to make the output recover.

Output Voltage Noise

The LT1963 regulators have been designed to provide low output voltage noise over the 10Hz to 100kHz bandwidth while operating at full load. Output voltage noise is typically $40\text{nV}/\sqrt{\text{Hz}}$ over this frequency bandwidth for the LT1963 (adjustable version). For higher output voltages (generated by using a resistor divider), the output voltage noise will be gained up accordingly. This results in RMS noise over the 10Hz to 100kHz bandwidth of $14\mu\text{V}_{\text{RMS}}$ for the LT1963 increasing to $38\mu\text{V}_{\text{RMS}}$ for the LT1963-3.3.

Higher values of output voltage noise may be measured when care is not exercised with regards to circuit layout and testing. Crosstalk from nearby traces can induce unwanted noise onto the output of the LT1963-X. Power supply ripple rejection must also be considered; the LT1963 regulators do not have unlimited power supply rejection and will pass a small portion of the input noise through to the output.

APPLICATIONS INFORMATION

Thermal Considerations

The power handling capability of the device is limited by the maximum rated junction temperature (125°C). The power dissipated by the device is made up of two components:

1. Output current multiplied by the input/output voltage differential: $(I_{OUT})(V_{IN} - V_{OUT})$, and
2. GND pin current multiplied by the input voltage: $(I_{GND})(V_{IN})$.

The GND pin current can be found using the GND Pin Current curves in the Typical Performance Characteristics. Power dissipation will be equal to the sum of the two components listed above.

The LT1963 series regulators have internal thermal limiting designed to protect the device during overload conditions. For continuous normal conditions, the maximum junction temperature rating of 125°C must not be exceeded. It is important to give careful consideration to all sources of thermal resistance from junction to ambient. Additional heat sources mounted nearby must also be considered.

For surface mount devices, heat sinking is accomplished by using the heat spreading capabilities of the PC board and its copper traces. Copper board stiffeners and plated through-holes can also be used to spread the heat generated by power devices.

The following tables list thermal resistance for several different board sizes and copper areas. All measurements were taken in still air on 1/16" FR-4 board with one ounce copper.

Table 1. Q Package, 5-Lead DD

COPPER AREA		BOARD AREA	THERMAL RESISTANCE (JUNCTION-TO-AMBIENT)
TOPSIDE*	BACKSIDE		
2500mm ²	2500mm ²	2500mm ²	23°C/W
1000mm ²	2500mm ²	2500mm ²	25°C/W
125mm ²	2500mm ²	2500mm ²	33°C/W

* Device is mounted on top side

Table 2. SO-8 Package, 8-Lead SO

COPPER AREA		BOARD AREA	THERMAL RESISTANCE (JUNCTION-TO-AMBIENT)
TOPSIDE*	BACKSIDE		
2500mm ²	2500mm ²	2500mm ²	55°C/W
1000mm ²	2500mm ²	2500mm ²	55°C/W
225mm ²	2500mm ²	2500mm ²	63°C/W
100mm ²	2500mm ²	2500mm ²	69°C/W

* Device is mounted on top side

Table 3. SOT-223 Package, 3-Lead SOT-223

COPPER AREA		BOARD AREA	THERMAL RESISTANCE (JUNCTION-TO-AMBIENT)
TOPSIDE*	BACKSIDE		
2500mm ²	2500mm ²	2500mm ²	42°C/W
1000mm ²	2500mm ²	2500mm ²	42°C/W
225mm ²	2500mm ²	2500mm ²	50°C/W
100mm ²	2500mm ²	2500mm ²	56°C/W
1000mm ²	1000mm ²	1000mm ²	49°C/W
1000mm ²	0mm ²	1000mm ²	52°C/W

* Device is mounted on top side

Table 4. FE Package, 16-Lead TSSOP

COPPER AREA		BOARD AREA	THERMAL RESISTANCE (JUNCTION-TO-AMBIENT)
TOPSIDE*	BACKSIDE		
2500mm ²	2500mm ²	2500mm ²	38°C/W
1000mm ²	2500mm ²	2500mm ²	43°C/W
225mm ²	2500mm ²	2500mm ²	48°C/W
100mm ²	2500mm ²	2500mm ²	60°C/W

* Device is mounted on top side

T Package, 5-Lead TO-220

Thermal Resistance (Junction-to-Case) = 4°C/W

Calculating Junction Temperature

Example: Given an output voltage of 3.3V, an input voltage range of 4V to 6V, an output current range of 0mA to 500mA and a maximum ambient temperature of 50°C, what will the maximum junction temperature be?

The power dissipated by the device will be equal to:

$$I_{OUT(MAX)}(V_{IN(MAX)} - V_{OUT}) + I_{GND}(V_{IN(MAX)})$$

where,

$$I_{OUT(MAX)} = 500\text{mA}$$

$$V_{IN(MAX)} = 6\text{V}$$

$$I_{GND} \text{ at } (I_{OUT} = 500\text{mA}, V_{IN} = 6\text{V}) = 10\text{mA}$$

So,

$$P = 500\text{mA}(6\text{V} - 3.3\text{V}) + 10\text{mA}(6\text{V}) = 1.41\text{W}$$

APPLICATIONS INFORMATION

Using a DD package, the thermal resistance will be in the range of 23°C/W to 33°C/W depending on the copper area. So the junction temperature rise above ambient will be approximately equal to:

$$1.41W(28^{\circ}\text{C}/\text{W}) = 39.5^{\circ}\text{C}$$

The maximum junction temperature will then be equal to the maximum junction temperature rise above ambient plus the maximum ambient temperature or:

$$T_{\text{JMAX}} = 50^{\circ}\text{C} + 39.5^{\circ}\text{C} = 89.5^{\circ}\text{C}$$

Protection Features

The LT1963 regulators incorporate several protection features which make them ideal for use in battery-powered circuits. In addition to the normal protection features associated with monolithic regulators, such as current limiting and thermal limiting, the devices are protected against reverse input voltages, reverse output voltages and reverse voltages from output to input.

Current limit protection and thermal overload protection are intended to protect the device against current overload conditions at the output of the device. For normal operation, the junction temperature should not exceed 125°C.

The input of the device will withstand reverse voltages of 20V. Current flow into the device will be limited to less than 1mA (typically less than 100µA) and no negative voltage will appear at the output. The device will protect both itself and the load. This provides protection against batteries that can be plugged in backward.

The output of the LT1963 can be pulled below ground without damaging the device. If the input is left open circuit or grounded, the output can be pulled below ground by 20V. For fixed voltage versions, the output will act like a large resistor, typically 5k or higher, limiting current flow to typically less than 600µA. For adjustable versions, the output will act like an open circuit; no current will flow out of the pin. If the input is powered by a voltage source, the output will source the short-circuit current of the device and will protect itself by thermal limiting. In this case, grounding the SHDN pin will turn off the device and stop the output from sourcing the short-circuit current.

The ADJ pin of the adjustable device can be pulled above or below ground by as much as 7V without damaging the

device. If the input is left open circuit or grounded, the ADJ pin will act like an open circuit when pulled below ground and like a large resistor (typically 5k) in series with a diode when pulled above ground.

In situations where the ADJ pin is connected to a resistor divider that would pull the ADJ pin above its 7V clamp voltage if the output is pulled high, the ADJ pin input current must be limited to less than 5mA. For example, a resistor divider is used to provide a regulated 1.5V output from the 1.21V reference when the output is forced to 20V. The top resistor of the resistor divider must be chosen to limit the current into the ADJ pin to less than 5mA when the ADJ pin is at 7V. The 13V difference between OUT and ADJ pins divided by the 5mA maximum current into the ADJ pin yields a minimum top resistor value of 2.6k.

In circuits where a backup battery is required, several different input/output conditions can occur. The output voltage may be held up while the input is either pulled to ground, pulled to some intermediate voltage, or is left open circuit. Current flow back into the output will follow the curve shown in Figure 5.

When the IN pin of the LT1963 is forced below the OUT pin or the OUT pin is pulled above the IN pin, input current will typically drop to less than 2µA. This can happen if the input of the device is connected to a discharged (low voltage) battery and the output is held up by either a backup battery or a second regulator circuit. The state of the SHDN pin will have no effect on the reverse output current when the output is pulled above the input.

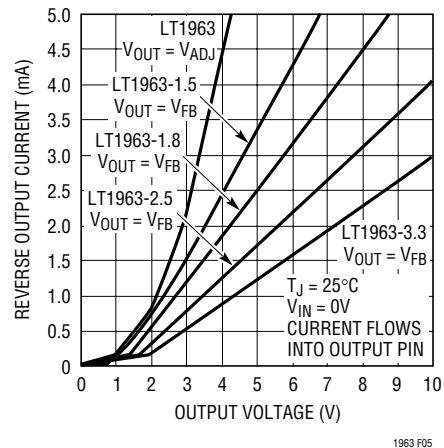
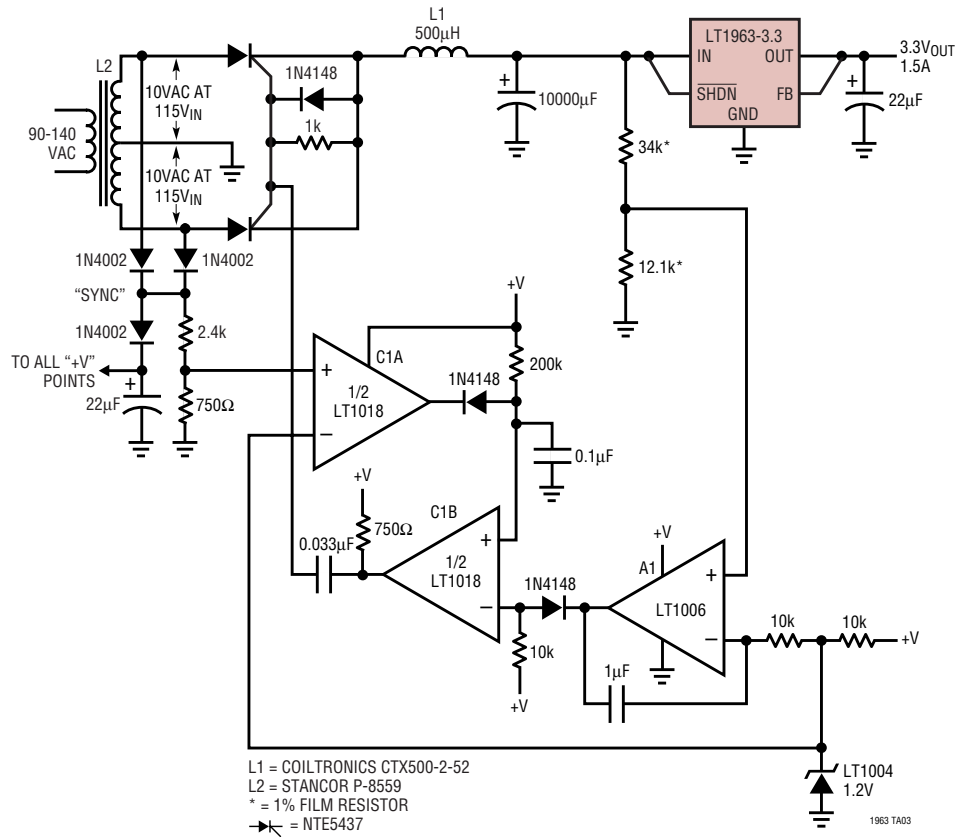

Figure 5. Reverse Output Current

TYPICAL APPLICATIONS

SCR Pre-Regulator Provides Efficiency Over Line Variations



Paralleling of Regulators for Higher Output Current

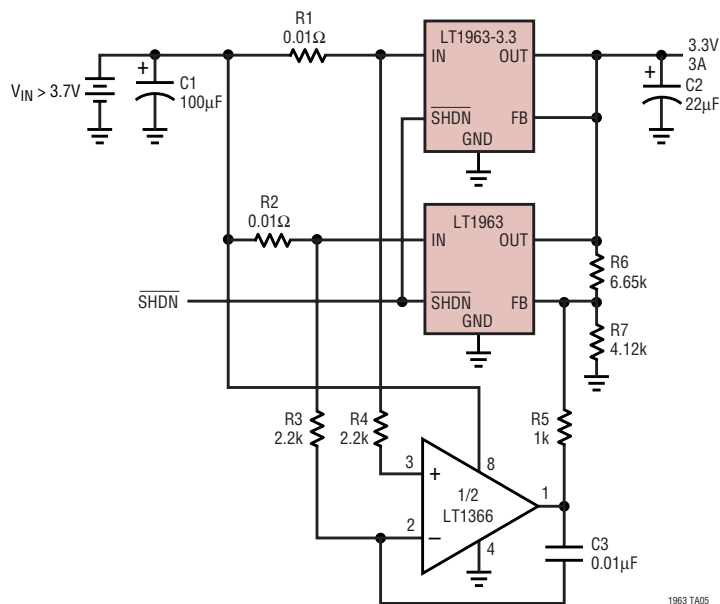

PACKAGE DESCRIPTION

Q Package
5-Lead Plastic DD Pak
 (Reference LTC DWG # 05-08-1461)

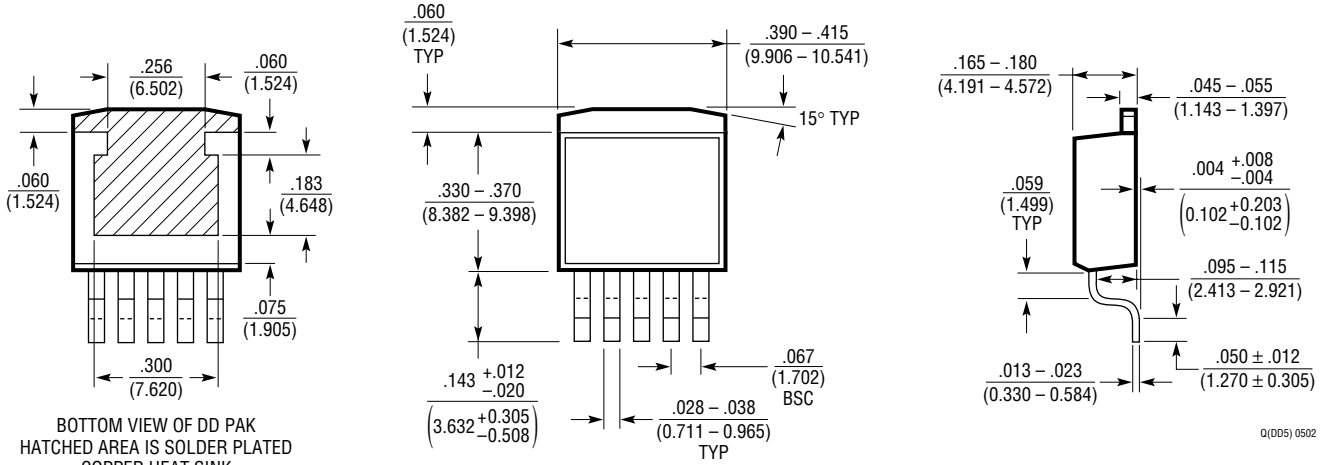

BOTTOM VIEW OF DD PAK
 HATCHED AREA IS SOLDER PLATED
 COPPER HEAT SINK

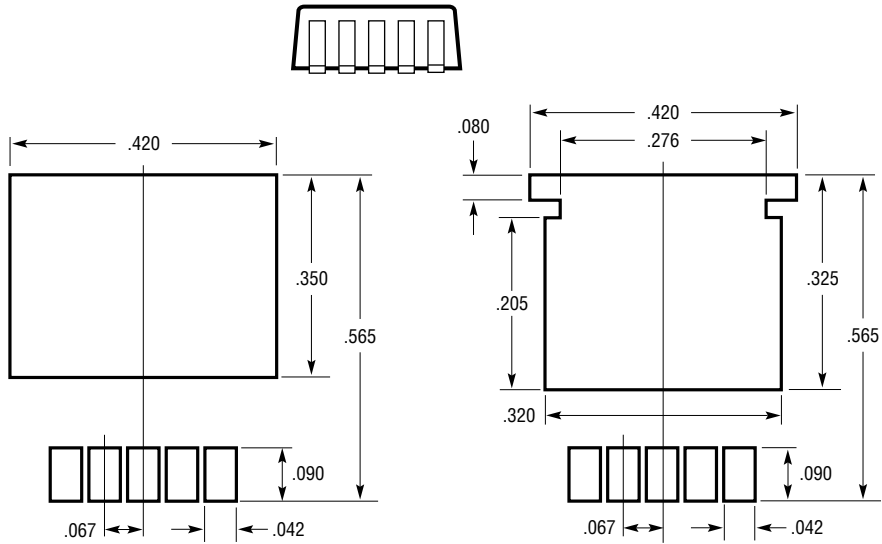

RECOMMENDED SOLDER PAD LAYOUT
 NOTE:
 1. DIMENSIONS IN INCH/(MILLIMETER)
 2. DRAWING NOT TO SCALE

RECOMMENDED SOLDER PAD LAYOUT
 FOR THICKER SOLDER PASTE APPLICATIONS

PACKAGE DESCRIPTION

S8 Package
8-Lead Plastic Small Outline (Narrow .150 Inch)
 (Reference LTC DWG # 05-08-1610)

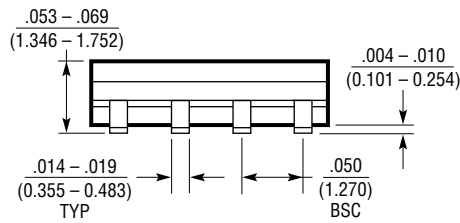
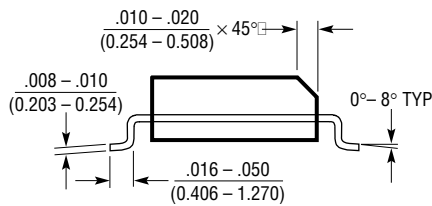
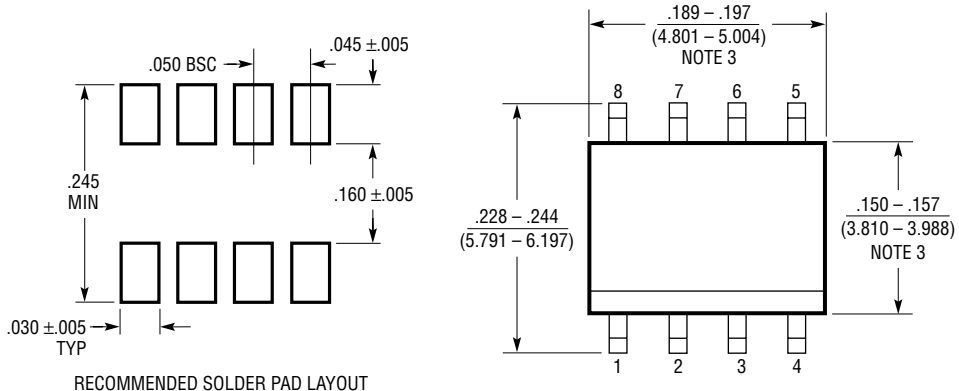

- NOTE:
 1. DIMENSIONS IN $\frac{\text{INCHES}}{\text{MILLIMETERS}}$
 2. DRAWING NOT TO SCALE
 3. THESE DIMENSIONS DO NOT INCLUDE MOLD FLASH OR PROTRUSIONS.
 MOLD FLASH OR PROTRUSIONS SHALL NOT EXCEED .006" (0.15mm)

508 0303

PACKAGE DESCRIPTION

ST Package
3-Lead Plastic SOT-223
 (Reference LTC DWG # 05-08-1630)

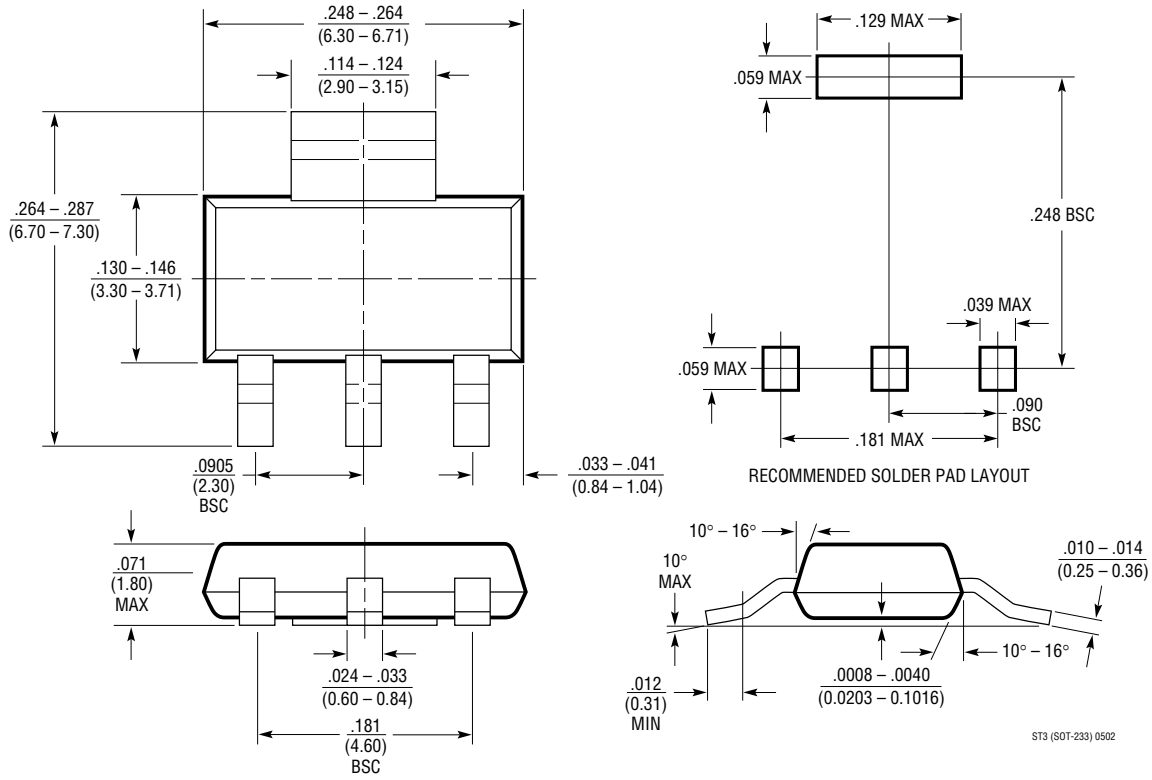

T Package
5-Lead Plastic TO-220 (Standard)
 (Reference LTC DWG # 05-08-1421)

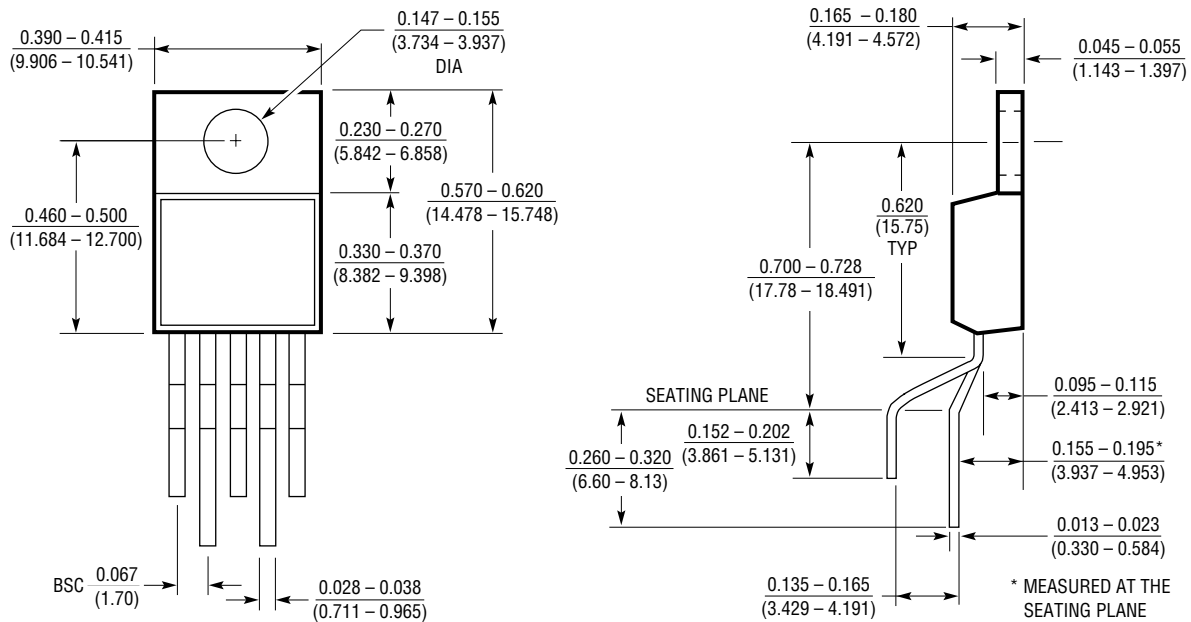

PACKAGE DESCRIPTION

FE Package
16-Lead Plastic TSSOP (4.4mm)
 (Reference LTC DWG # 05-08-1663)
Exposed Pad Variation BB

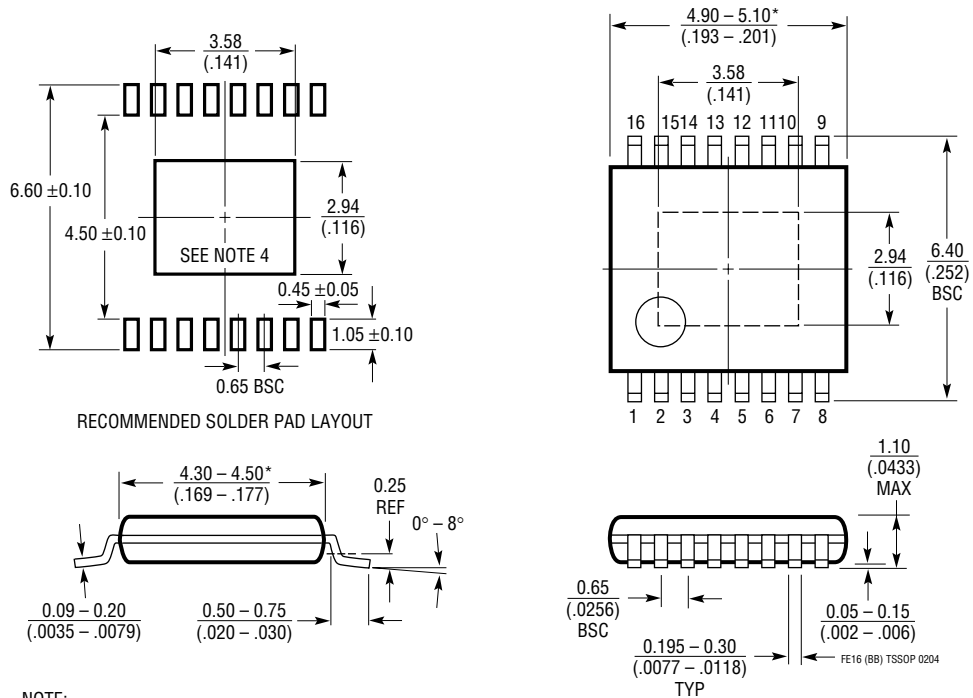

- NOTE:
1. CONTROLLING DIMENSION: MILLIMETERS
 2. DIMENSIONS ARE IN MILLIMETERS (INCHES)
 3. DRAWING NOT TO SCALE
 4. RECOMMENDED MINIMUM PCB METAL SIZE FOR EXPOSED PAD ATTACHMENT
 *DIMENSIONS DO NOT INCLUDE MOLD FLASH. MOLD FLASH SHALL NOT EXCEED 0.150mm (.006") PER SIDE

TYPICAL APPLICATIONS

Adjustable Current Source

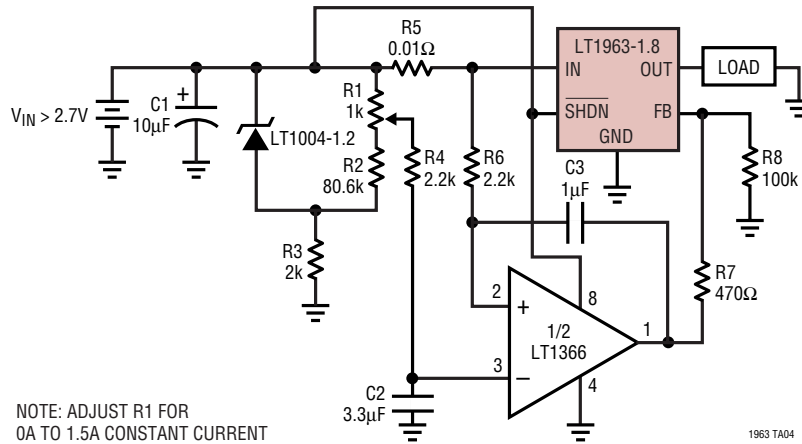

RELATED PARTS

PART NUMBER	DESCRIPTION	COMMENTS
LT1129	700mA, Micropower, LDO	V_{IN} : 4.2V to 30V, $V_{OUT(MIN)}$ = 3.75V, V_{DO} = 0.40V, I_Q = 50µA, I_{SD} = 16µA, DD, SOT-223, S8, TO220, TSSOP20 Packages
LT1175	500mA, Micropower Negative LDO	V_{IN} : -20V to -4.3V, $V_{OUT(MIN)}$ = -3.8V, V_{DO} = 0.50V, I_Q = 45µA, I_{SD} = 10µA, DD, SOT-223, S8 Packages
LT1185	3A, Negative LDO	V_{IN} : -35V to -4.2V, $V_{OUT(MIN)}$ = -2.40V, V_{DO} = 0.80V, I_Q = 2.5mA, I_{SD} < 1µA, TO220-5 Package
LT1761	100mA, Low Noise Micropower, LDO	V_{IN} : 1.8V to 20V, $V_{OUT(MIN)}$ = 1.22V, V_{DO} = 0.30V, I_Q = 20µA, I_{SD} < 1µA, ThinSOT Package
LT1762	150mA, Low Noise Micropower, LDO	V_{IN} : 1.8V to 20V, $V_{OUT(MIN)}$ = 1.22V, V_{DO} = 0.30V, I_Q = 25µA, I_{SD} < 1µA, MS8 Package
LT1763	500mA, Low Noise Micropower, LDO	V_{IN} : 1.8V to 20V, $V_{OUT(MIN)}$ = 1.22V, V_{DO} = 0.30V, I_Q = 30µA, I_{SD} < 1µA, S8 Package
LT1764/ LT1764A	3A, Low Noise, Fast Transient Response, LDO	V_{IN} : 2.7V to 20V, $V_{OUT(MIN)}$ = 1.21V, V_{DO} = 0.34V, I_Q = 1mA, I_{SD} < 1µA, DD, TO220 Packages
LTC1844	150mA, Very Low Drop-Out LDO	V_{IN} : 6.5V to 1.6V, $V_{OUT(MIN)}$ = 1.25V, V_{DO} = 0.08V, I_Q = 40µA, I_{SD} < 1µA, ThinSOT Package
LT1962	300mA, Low Noise Micropower, LDO	V_{IN} : 1.8V to 20V, $V_{OUT(MIN)}$ = 1.22V, V_{DO} = 0.27V, I_Q = 30µA, I_{SD} < 1µA, MS8 Package
LT1963/ LT1963A	1.5A, Low Noise, Fast Transient Response, LDO	V_{IN} : 2.1V to 20V, $V_{OUT(MIN)}$ = 1.21V, V_{DO} = 0.34V, I_Q = 1mA, I_{SD} < 1µA, DD, TO220, SOT Packages
LT1964	200mA, Low Noise Micropower, Negative LDO	V_{IN} : -0.9V to -20V, $V_{OUT(MIN)}$ = -1.21V, V_{DO} = 0.34V, I_Q = 30µA, I_{SD} = 3µA, ThinSOT Package
LT3020	100mA, Low Voltage V_{LDO}	V_{IN} : 0.9V to 10V, $V_{OUT(MIN)}$ = 0.20, V_{DO} = 0.15V, I_Q = 120µA, I_{SD} < 3µA, DFN, MS8 Packages
LT3023	Dual, 2x 100mA, Low Noise Micropower, LDO	V_{IN} : 1.8V to 20V, $V_{OUT(MIN)}$ = 1.22V, V_{DO} = 0.30V, I_Q = 40µA, I_{SD} < 1µA, DFN, MS10 Packages
LT3024	Dual, 100mA/500mA, Low Noise Micropower, LDO	V_{IN} : 1.8V to 20V, $V_{OUT(MIN)}$ = 1.22V, V_{DO} = 0.30V, I_Q = 60µA, I_{SD} < 1µA, DFN, TSSOP Package
LT3150	Fast Transient Response, Low Input Voltage	V_{IN} : -1.4V to 10V, $V_{OUT(MIN)}$ = 1.23V, V_{DO} = 0.13V, I_Q = 12mA, I_{SD} = 25µA, GN16 Package

1963fc