

ABSOLUTE MAXIMUM RATINGS

(Note 1)

Total Supply Voltage (V^+ to V^-)	14V
Input Differential Voltage	14V
Input Current	$\pm 25\text{mA}$
Output Short-Circuit Duration	Continuous
Operating Temperature Range	

(Note 2)

.....	-40°C to 85°C
Junction Temperature	150°C
Storage Temperature Range	-65°C to 150°C
Lead Temperature (Soldering, 10 sec)	300°C

PACKAGE/ORDER INFORMATION

TOP VIEW

N8 PACKAGE 8-LEAD PDIP S8 PACKAGE 8-LEAD PLASTIC SO

$T_{JMAX} = 150^\circ\text{C}$, $\theta_{JA} = 130^\circ\text{C/W}$ (N8)
 $T_{JMAX} = 150^\circ\text{C}$, $\theta_{JA} = 190^\circ\text{C/W}$ (S8)

ORDER PART NUMBER	
LT1635CN8	LT1635CS8
LT1635IN8	LT1635IS8
S8 PART MARKING	
1635	1635I

Consult LTC Marketing for parts specified with wider operating temperature ranges.

ELECTRICAL CHARACTERISTICS

5V OP AMP: The ● denotes the specifications which apply over the full operating temperature range, otherwise specifications are at $T_A = 25^\circ\text{C}$. $V_S = 5\text{V}$, 0V ; $V_{CM} = V_{OUT} = 2.5\text{V}$, unless otherwise noted. (Note 2)

SYMBOL	PARAMETER	CONDITIONS	MIN	TYP	MAX	UNITS
V_{OS}	Input Offset Voltage	$0^\circ\text{C} \leq T_A \leq 70^\circ\text{C}$	●	0.3	1.3	mV
		$-40^\circ\text{C} \leq T_A \leq 85^\circ\text{C}$	●	0.5	1.6	mV
						1.8
	Input Offset Voltage Drift	$-40^\circ\text{C} \leq T_A \leq 85^\circ\text{C}$ (Note 4)	●	3.0	7.0	$\mu\text{V}/^\circ\text{C}$
$V_{OS\ ADJ}$	Offset Voltage Adjust Range	Positive Adjust	●	6	8	mV
		Negative Adjust	●	-1.4	-2	mV
I_{OS}	Input Offset Current		●	0.2	0.6	nA
I_B	Input Bias Current		●	2.0	4.5	nA
				2.5	5.5	nA
	Input Noise Voltage	0.1Hz to 10Hz		1		μV_{P-P}
e_n	Input Noise Voltage Density	$f = 1\text{kHz}$		50		$\text{nV}/\sqrt{\text{Hz}}$
i_n	Input Noise Current Density	$f = 1\text{kHz}$		0.05		$\text{pA}/\sqrt{\text{Hz}}$
R_{IN}	Input Resistance	Differential	●	7	25	$\text{M}\Omega$
		Common Mode, $V_{CM} = 0\text{V}$ to 4V			6	$\text{G}\Omega$
	Input Voltage Range		●	0	4	V
CMRR	Common Mode Rejection Ratio	$V_{CM} = 0\text{V}$ to 4V	●	92	110	dB
				85	97	dB
A_{VOL}	Large-Signal Voltage Gain	$V_O = 200\text{mV}$ to 4.5V , No Load	●	100	450	V/mV
		$V_O = 200\text{mV}$ to 4.5V , $R_L = 1.1\text{k}$	●	45	200	V/mV
		$V_O = 200\text{mV}$ to 4.5V , $R_L = 500\Omega$	●	35	150	V/mV
	Shunt Gain	$I_{OUT} = 0.1\text{mA}$ to 5mA $V_O = 1.5\text{V}$ to 6.45V (Note 5)	●	15	25	V/mV
V_{OL}	Output Voltage Swing Low	$V_S = 5\text{V}$, No Load	●	2	10	mV
		$V_S = 5\text{V}$, $I_{SINK} = 5\text{mA}$	●	125	250	mV
		$V_S = 5\text{V}$, $I_{SINK} = 10\text{mA}$	●	200	500	mV
V_{OH}	Output Voltage Swing High	$V_S = 5\text{V}$, No Load	●	4.975	4.985	V
		$V_S = 5\text{V}$, $I_{SOURCE} = 5\text{mA}$	●	4.65	4.8	V
		$V_S = 5\text{V}$, $I_{SOURCE} = 10\text{mA}$	●	4.55	4.75	V

ELECTRICAL CHARACTERISTICS

5V OP AMP: The ● denotes the specifications which apply over the full operating temperature range, otherwise specifications are at $T_A = 25^\circ\text{C}$. $V_S = 5\text{V}$, 0V ; $V_{\text{CM}} = V_{\text{OUT}} = 2.5\text{V}$, unless otherwise noted. (Note 2)

SYMBOL	PARAMETER	CONDITIONS		MIN	TYP	MAX	UNITS
I_{SC}	Short-Circuit Current	$V_S = 5\text{V}$, Short to GND	●	20	40		mA
		$V_S = 5\text{V}$, Short to V_{CC}	●	20	40		mA
PSRR	Power Supply Rejection Ratio	$V_S = 1.2\text{V}$ to 12V , $V_{\text{CM}} = V_O = 0.2\text{V}$	●	93	100		dB
				90	97		dB
	Minimum Operating Supply Voltage	(Note 3)	●		1.1	1.2	V
I_S	Supply Current		●		130	200	μA
					150	260	μA
GBW	Gain Bandwidth Product	$f = 1\text{kHz}$			175		kHz
SR	Slew Rate	$A_V = -1$, $R_L = \infty$			0.045		$\text{V}/\mu\text{s}$

5V REFERENCE: The ● denotes the specifications which apply over the full operating temperature range, otherwise specifications are at $T_A = 25^\circ\text{C}$. $V_S = 5\text{V}$, 0V , unless otherwise noted. (Note 2)

SYMBOL	PARAMETER	CONDITIONS		MIN	TYP	MAX	UNITS
V_{REF}	Feedback Sense Voltage	Voltage at Pin 1 with Pin 1 Connected to Pin 8 (Note 6)	●	189	200	211	mV
$\text{TC } V_{\text{REF}}$	Reference Drift	(Note 4)	●		30	100	ppm/ $^\circ\text{C}$
	Feedback Current	Current into Pin 8	●		3.5	10	nA
			●		5.0	15	nA
	Line Regulation	$0 \leq I_{\text{REF}} \leq 1\text{mA}$, $V_{\text{REF}} = 200\text{mV}$ $V_S = 1.2\text{V}$ to 5V $V_S = 1.3\text{V}$ to 5V (Note 3)	●		20	100	ppm/V
					30	200	ppm/V
	Load Regulation	$I_{\text{REF}} = 0$ to 1mA	●		150	300	ppm/mA
					200	500	ppm/mA
	Reference Amplifier Gain	$V_O = 0.2\text{V}$ to 3.5V	●	45	90		V/mV
					25	50	

$\pm 5\text{V}$ OP AMP: The ● denotes the specifications which apply over the full operating temperature range, otherwise specifications are at $T_A = 25^\circ\text{C}$. $V_S = \pm 5\text{V}$; $V_{\text{CM}} = V_{\text{OUT}} = 0\text{V}$, unless otherwise noted. (Note 2)

SYMBOL	PARAMETER	CONDITIONS		MIN	TYP	MAX	UNITS
V_{OS}	Input Offset Voltage	$0^\circ\text{C} \leq T_A \leq 70^\circ\text{C}$ $-40^\circ\text{C} \leq T_A \leq 85^\circ\text{C}$	●		0.3	1.5	mV
					0.5	1.9	mV
						2.1	mV
	Input Offset Voltage Drift	$0^\circ\text{C} \leq T_A \leq 85^\circ\text{C}$ (Note 4)	●		4.5	10.0	$\mu\text{V}/^\circ\text{C}$
$V_{\text{OS ADJ}}$	Offset Voltage Adjust Range	Positive Adjust Negative Adjust	●	6	8		mV
				-1.4	-2		mV
I_{OS}	Input Offset Current		●		0.2	0.6	nA
I_B	Input Bias Current		●		2.0	4.5	nA
					2.5	5.5	nA
	Input Noise Voltage	0.1Hz to 10Hz			1		$\mu\text{V}_{\text{p-p}}$
e_n	Input Noise Voltage Density	$f = 1\text{kHz}$			50		$\text{nV}/\sqrt{\text{Hz}}$
i_n	Input Noise Current Density	$f = 1\text{kHz}$			0.05		$\text{pA}/\sqrt{\text{Hz}}$
R_{IN}	Input Resistance	Differential Common Mode, $V_{\text{CM}} = -5\text{V}$ to 4V	●	7	35		$\text{M}\Omega$
					9		$\text{G}\Omega$
	Input Voltage Range		●	-5		4	V
CMRR	Common Mode Rejection Ratio	$V_{\text{CM}} = -5\text{V}$ to 4V	●	94	115		dB
				91	110		dB

ELECTRICAL CHARACTERISTICS

±5V OP AMP: The ● denotes the specifications which apply over the full operating temperature range, otherwise specifications are at $T_A = 25^\circ\text{C}$. $V_S = \pm 5\text{V}$; $V_{CM} = V_{OUT} = 0\text{V}$, unless otherwise noted. (Note 2)

SYMBOL	PARAMETER	CONDITIONS	MIN	TYP	MAX	UNITS
A_{VOL}	Large-Signal Voltage Gain	$V_O = -4.5\text{V to } 4.5\text{V}$, No Load	●	175	300	V/mV
		$V_O = -4.5\text{V to } 4.5\text{V}$, $R_L = 1.1\text{k}$	●	15	100	V/mV
		$V_O = -4.5\text{V to } 4.5\text{V}$, $R_L = 500\Omega$	●	10	60	V/mV
V_O	Output Voltage Swing	$V_S = \pm 5\text{V}$, No Load	●	±4.975	±4.985	mV
		$V_S = \pm 5\text{V}$, $I_{SINK} = 5\text{mA}$	●	±4.65	±4.75	mV
		$V_S = \pm 5\text{V}$, $I_{SINK} = 10\text{mA}$	●	±4.5	±4.6	mV
I_{SC}	Short-Circuit Current	$V_S = \pm 5\text{V}$		±20	±40	mA
PSRR	Power Supply Rejection Ratio	$V_S = \pm 1\text{V to } \pm 6\text{V}$, $V_{CM} = V_O = 0\text{V}$		90	100	dB
			●	88	98	dB
I_S	Supply Current			135	215	μA
			●	160	280	μA
GBW	Gain Bandwidth Product	$f = 1\text{kHz}$		175		kHz
SR	Slew Rate	$A_V = -1$, $R_L = \infty$		0.05		V/μs

±5V REFERENCE: The ● denotes the specifications which apply over the full operating temperature range, otherwise specifications are at $T_A = 25^\circ\text{C}$. $V_S = \pm 5\text{V}$, unless otherwise noted. (Note 2)

SYMBOL	PARAMETER	CONDITIONS	MIN	TYP	MAX	UNITS	
V_{REF}	Feedback Sense Voltage	Voltage at Pin 1 with Pin 1 Connected to Pin 8 (Note 6)	●	189	200	211	mV
TC V_{REF}	Reference Drift	(Note 4)	●	40	120	ppm/°C	
	Feedback Current	Current into Pin 8	●	3.5	10	15	nA
	Line Regulation	$0 \leq I_{REF} \leq 1\text{mA}$, $V_{REF} = 200\text{mV}$ $V_S = \pm 0.6\text{V to } \pm 5\text{V}$ $V_S = \pm 0.65\text{V to } \pm 5\text{V}$ (Note 3)		20	100	ppm/V	
			●	30	200	ppm/V	
	Load Regulation	$I_{REF} = 0$ to 1mA		150	300	ppm/mA	
			●	200	500	ppm/mA	
	Reference Amplifier Gain	$V_O = 0.2\text{V to } 8.5\text{V}$ $V_S = 10\text{V}, 0\text{V}$		45	90	V/mV	
			●	25	50	V/mV	

Note 1: Absolute Maximum Ratings are those values beyond which the life of a device may be impaired.

Note 2: The LT1635C is guaranteed to operate over the commercial temperature range of 0°C to 70°C . It is designed, characterized and expected to meet these extended temperature limits, but is not tested at -40°C and 85°C . The LT1635I is guaranteed to meet the industrial temperature range.

Note 3: The LT1635 op amp operates on a 1.2V supply over the full industrial temperature range with an input common mode voltage of 0V to 0.2V. The minimum supply voltage for the reference to operate properly over this temperature range is 1.3V.

Note 4: This parameter is not 100% tested. Temperature coefficient is measured by dividing the change in output voltage by specified temperature range.

Note 5: Shunt gain defines the operation in floating applications when the output is connected to the V^+ terminal and input common mode is referred to V^- .

Note 6: If part is stored outside of the specified temperature range, the output may shift due to hysteresis.

TYPICAL PERFORMANCE CHARACTERISTICS Op Amp

Supply Current vs Supply Voltage

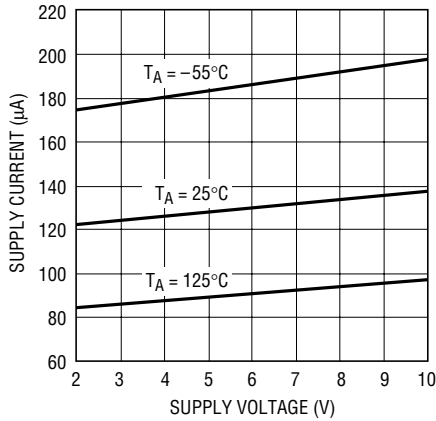

1635 G01

Input Bias and Offset Currents vs Temperature

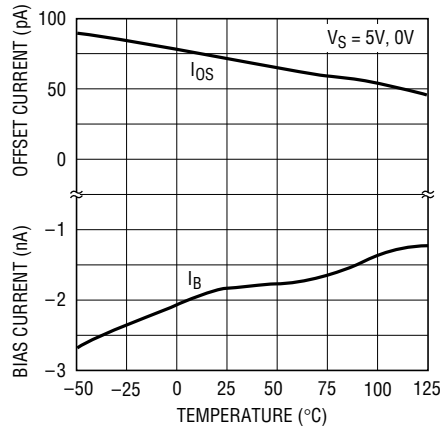

1635 G02

Input Bias Current vs Common Mode Voltage

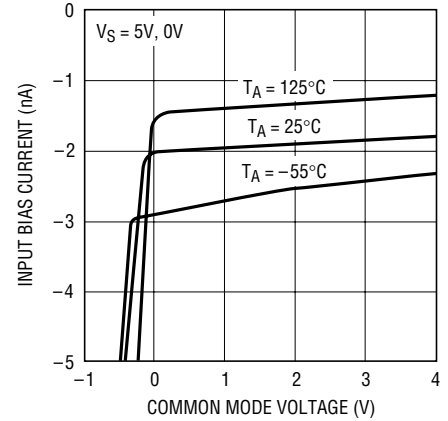

1635 G03

0.1Hz to 10Hz Noise Voltage

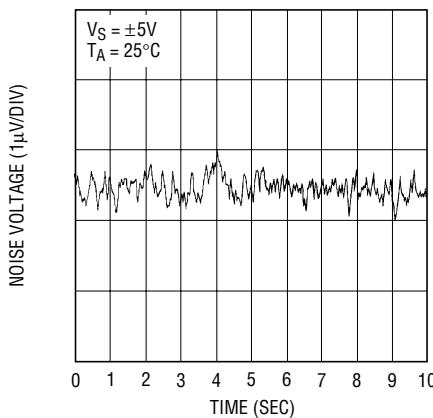

1635 G04

Noise Voltage Density vs Frequency

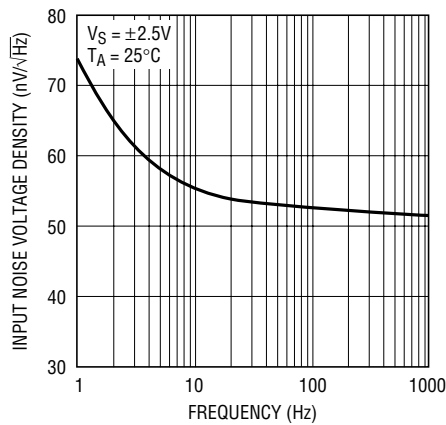

1635 G05

Input Noise Current vs Frequency

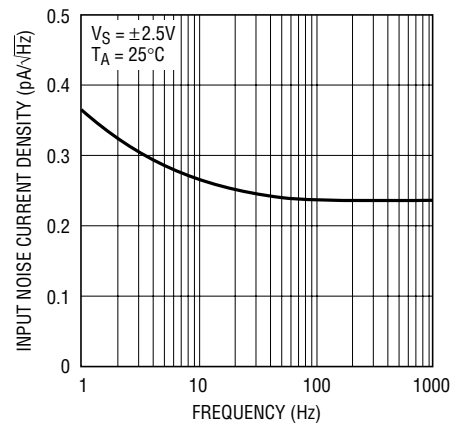

1635 G06

Typical Distribution of Offset Voltage Drift with Temperature

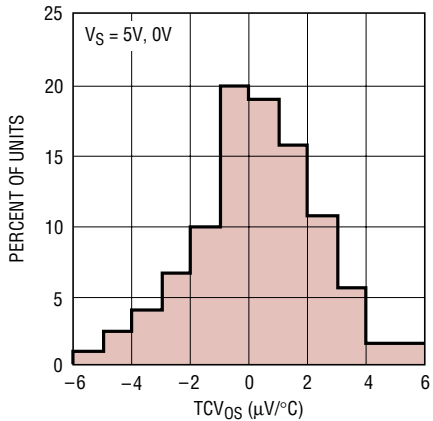

1635 G07

Minimum Supply Voltage

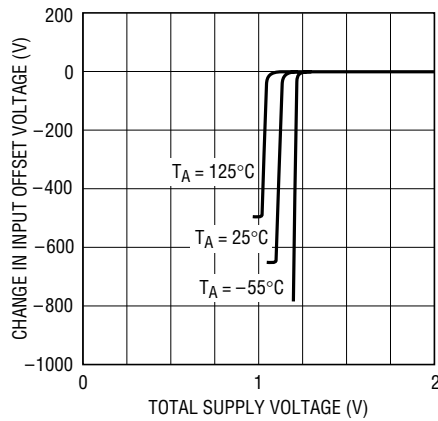

1635 G08

Turn-On Drift of Three Typical Units

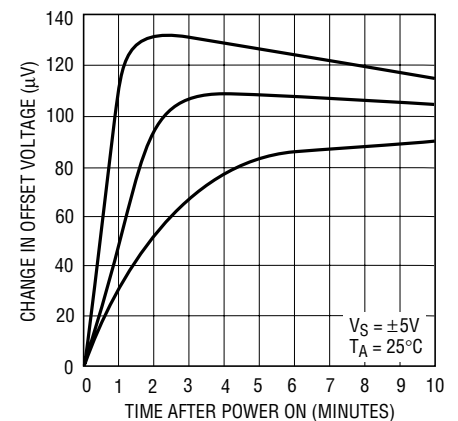

1635 G09

TYPICAL PERFORMANCE CHARACTERISTICS Op Amp

Voltage Gain vs Frequency

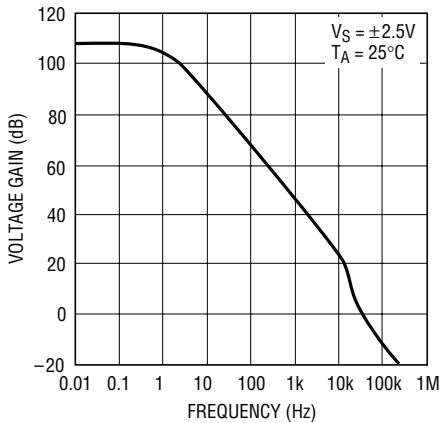

1635 G10

Gain Phase vs Frequency

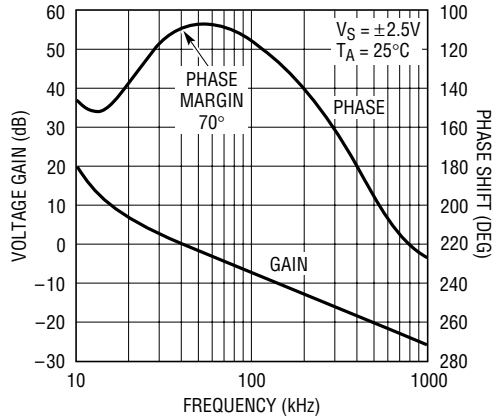

1635 G11

Capacitive Load Handling

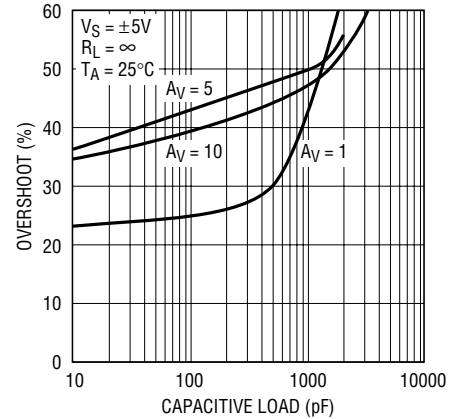

1635 G12

Slew Rate vs Temperature

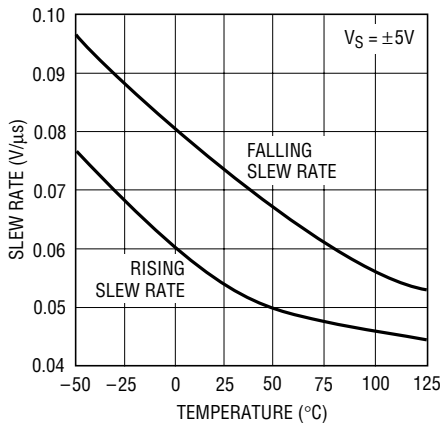

1635 G13

Gain-Bandwidth Product and Phase Margin vs Temperature

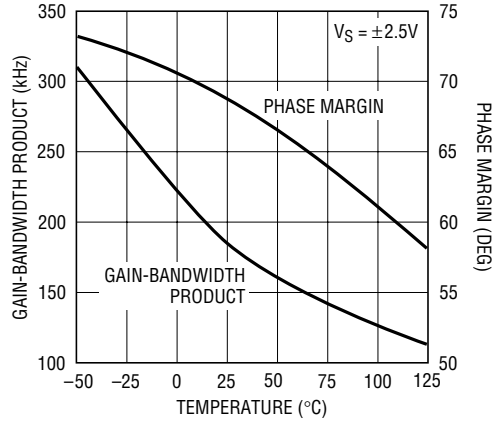

1635 G14

Voltage Gain vs Load Resistance

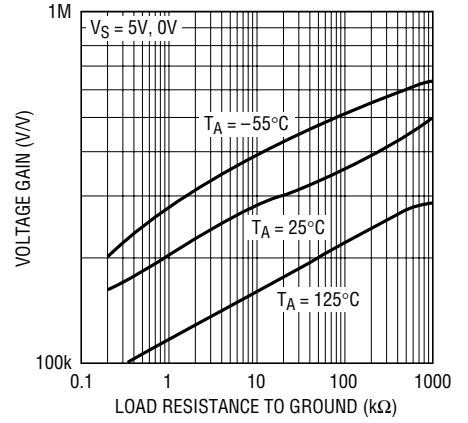

1635 G15

Shunt Gain

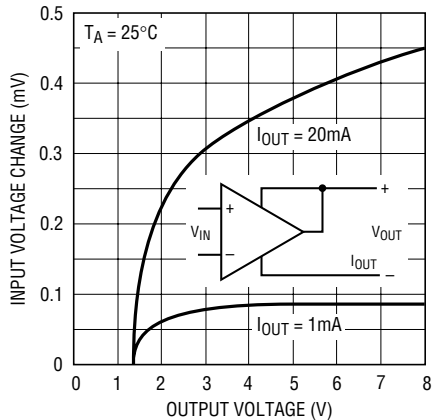

1635 G16

Large-Signal Transient Response VS = ±5V

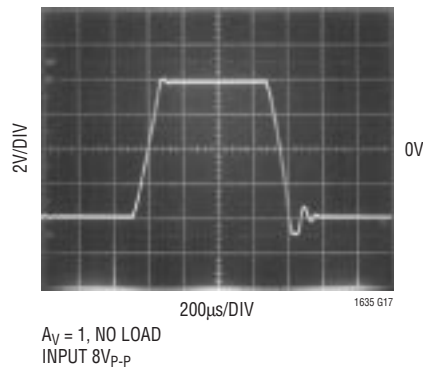

1635 G17

Large-Signal Transient Response VS = 5V, 0V

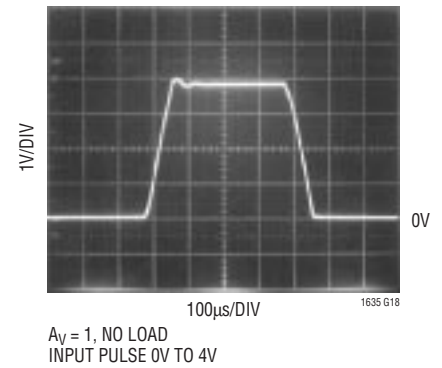

1635 G18

TYPICAL PERFORMANCE CHARACTERISTICS Op Amp

Output Saturation Voltage vs Input Overdrive

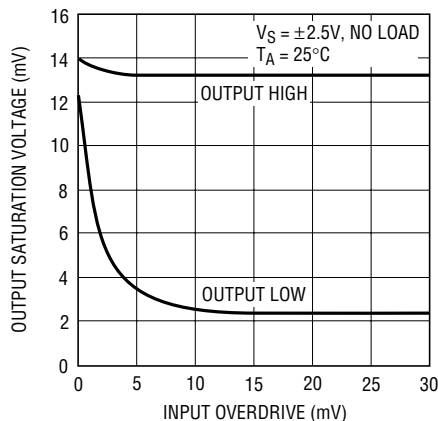

1635 G19

Output Saturation Voltage vs Load Current (Output Low)

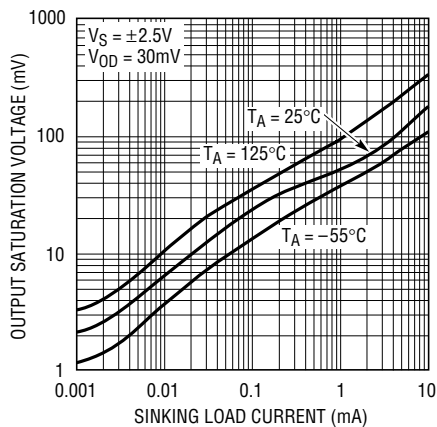

1635 G20

Output Saturation Voltage vs Load Current (Output High)

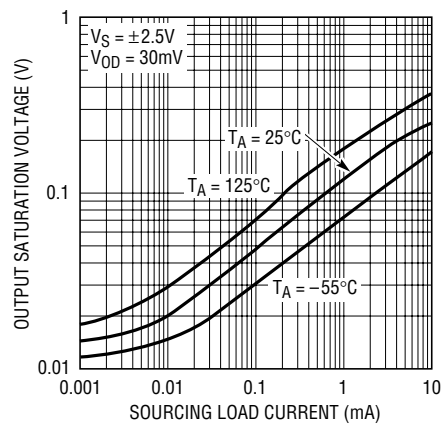

1635 G21

Common Mode Range vs Temperature

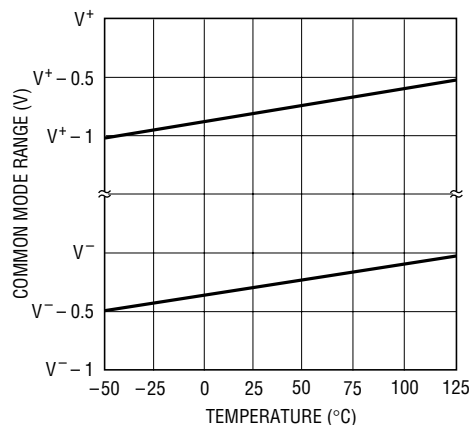

1635 G22

Common Mode Rejection Ratio vs Frequency

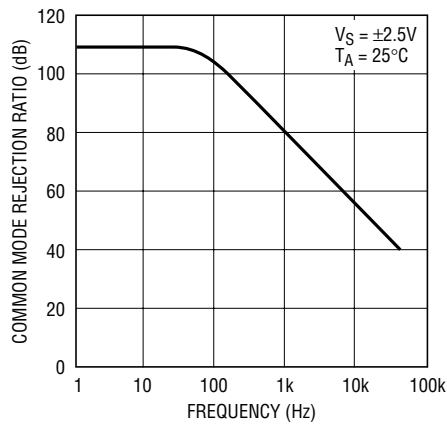

1635 G23

Power Supply Rejection Ratio vs Frequency

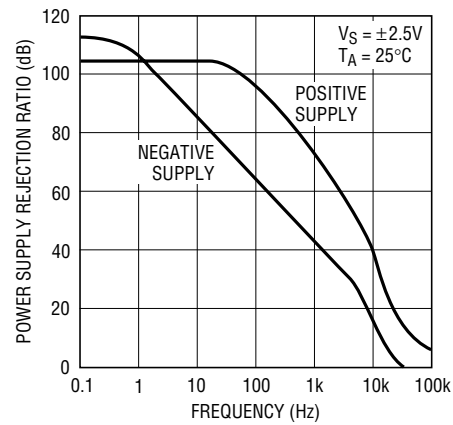

1635 G24

Output Impedance vs Frequency

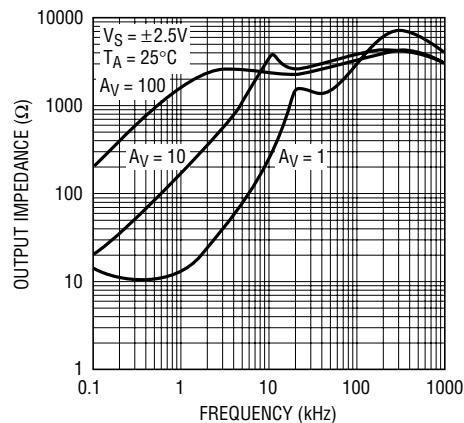

1635 G25

Small-Signal Transient Response VS = ±5V

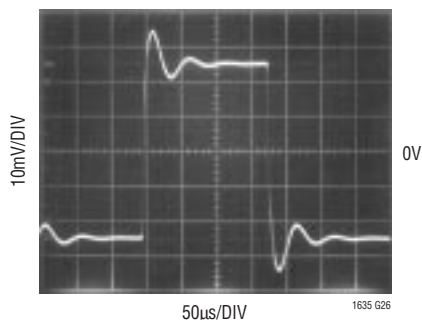

1635 G26

Small-Signal Transient Response VS = 5V, 0V

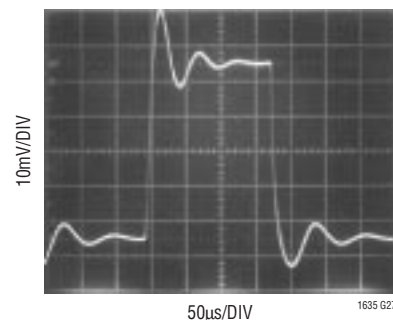

1635 G27

TYPICAL PERFORMANCE CHARACTERISTICS Reference

Typical Distribution of Initial Accuracy

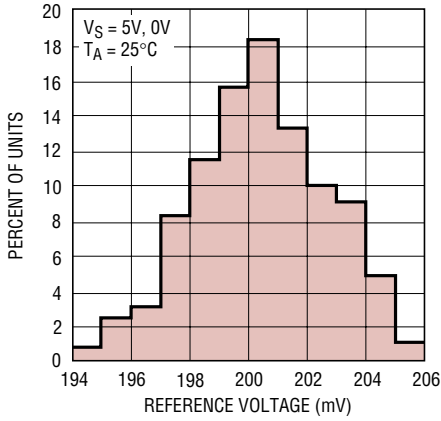

1635 G28

Line Regulation

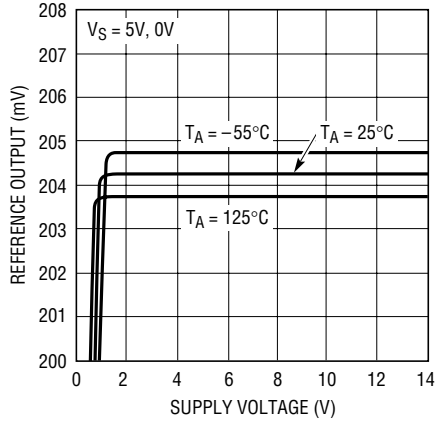

1635 G29

Load Regulation

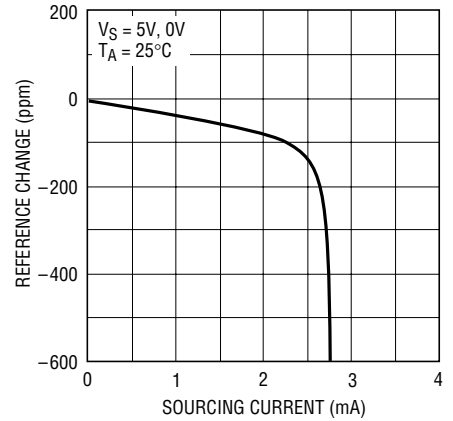

1635 G30

Reference Output vs Temperature of Two Typical Units

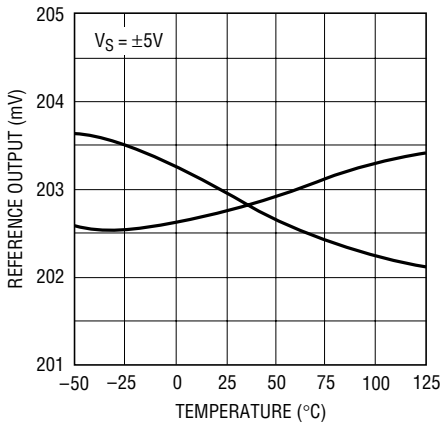

1635 G31

Output Saturation vs Load Current (Sourcing)

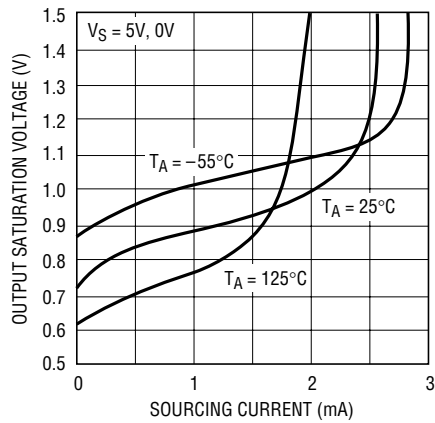

1635 G32

Reference Amplifier Gain

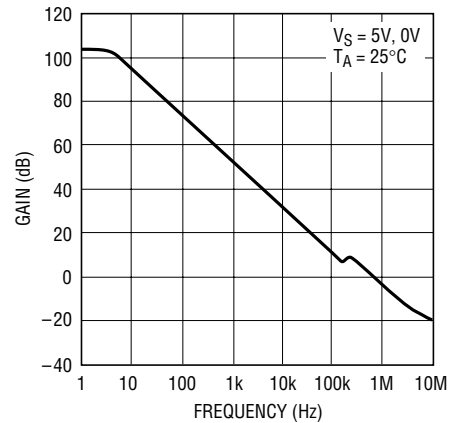

1635 G33

BLOCK DIAGRAM

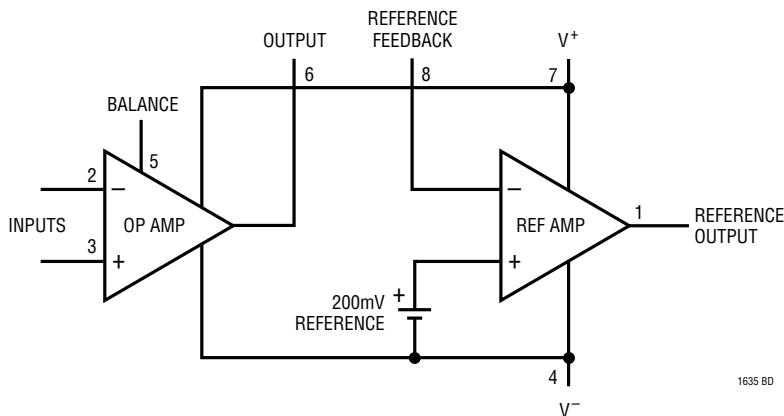

1635 BD

APPLICATIONS INFORMATION

The LT1635 is fully specified with $V^+ = 5V$, $V^- = 0V$ and $V_{CM} = 2.5V$. The op amp offset voltage is internally trimmed to a minimum value at these supply voltages. A unique feature of this device is that it operates from a single 1.2V supply up to $\pm 5V$. A full set of specifications is provided at $\pm 5V$ supply voltages. The positive supply pin of the LT1635 should be bypassed with a small capacitor (about $0.1\mu F$), as well as the negative supply pin when using split supplies.

Op Amp

The LT1635 is fully specified for single supply operation, i.e., when the negative supply is $0V$. Input common mode range of the op amp includes ground and the output swings within a few millivolts of ground while sinking current. The input stage of the op amp incorporates phase reversal protection to prevent false outputs from occurring when the input is below the negative supply. Protective resistors have been included in the input leads so that current does not become excessive when the inputs are forced below the negative supply.

The op amp also includes an offset nulling feature, this is accomplished by connecting the BALANCE pin (Pin 5) to a variable voltage derived from the reference output. The offset adjust range is asymmetrical, typically $-2mV$ to $8mV$. At room temperature the input offset voltage of the LT1635 is within the null range, thus the offset voltage can be adjusted to zero. Figure 1 shows the standard offset adjustment.

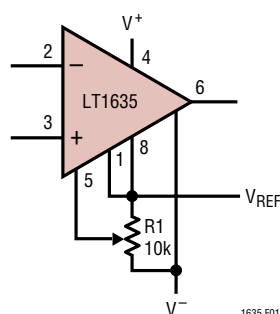

Figure 1. Standard Offset Adjustment

Output

The output voltage swing of the LT1635 is a function of input overdrive as shown in the typical performance curves. When monitoring voltages within $15mV$ of either rail, gain

should be taken to keep the output from saturating. For example, a $1mV$ input signal will cause the amplifier to set up in its linear region in the gain 100 configuration as shown in Figure 2a. However, $1mV$ is not enough to make the amplifier function properly in the voltage follower mode (Figure 2b).

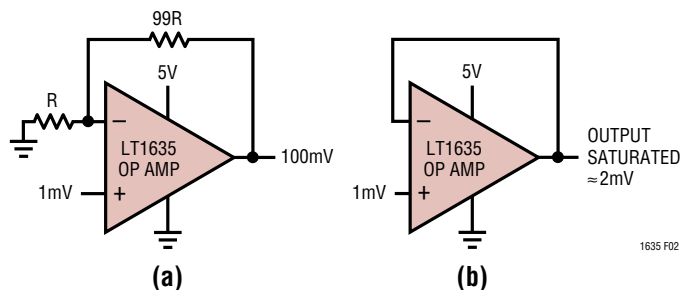

Figure 2. Gain 100 Amplifier and Voltage Follower

Distortion

There are two main contributors of distortion in op amps: distortion caused by nonlinear common mode rejection and output crossover distortion as the output transitions from sourcing to sinking current. The common mode rejection ratio of the LT1635 is very good, typically $110dB$. Therefore, as long as the input operates in normal common mode range, there will be very little common mode induced distortion. Crossover distortion will increase as the output load resistance decreases. For the lowest distortion, the LT1635 should be operated with the output always sourcing current.

Reference

The reference of the LT1635 consists of a $200mV$ precision bandgap and a reference amplifier. As shown in the block diagram, the $0.2V$ precision bandgap is referred to V^- and is internally connected to the noninverting input of the reference amplifier. This configuration offers great flexibility in that the reference voltage can be amplified or the reference amplifier can be used as a comparator. Unlike the op amp, the output of the reference amplifier can only swing within $0.8V$ (typ) of the positive rail. To guarantee that the reference amplifier does not saturate over the industrial temperature range, the minimum operating supply should be $1.3V$. The reference amplifier can source $2mA$ of load current and can sink $10\mu A$ over the industrial temperature range.

TYPICAL APPLICATIONS

Low Voltage Regulator

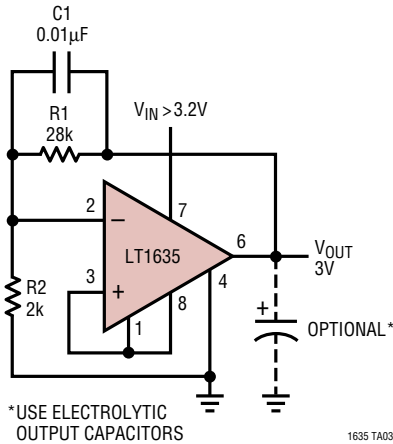

Best Regulation

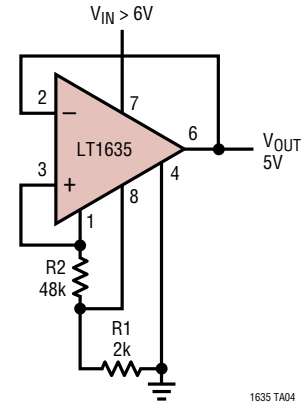

2-Terminal Current Regulator

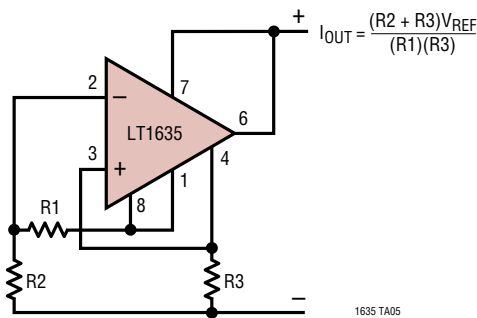

Shunt Regulator

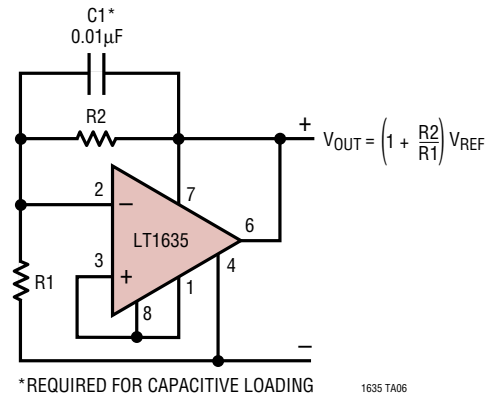

Negative Regulator

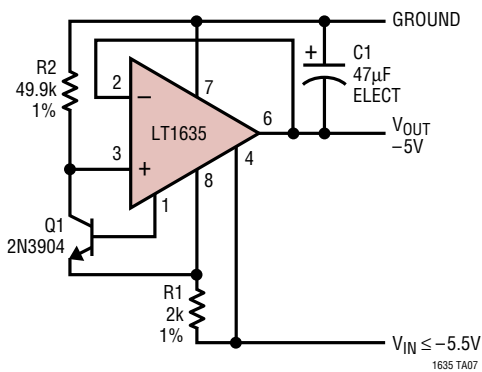

6V Battery-Level Indicator

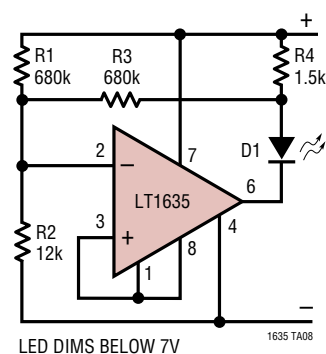

SIMPLIFIED SCHEMATICS

Op Amp

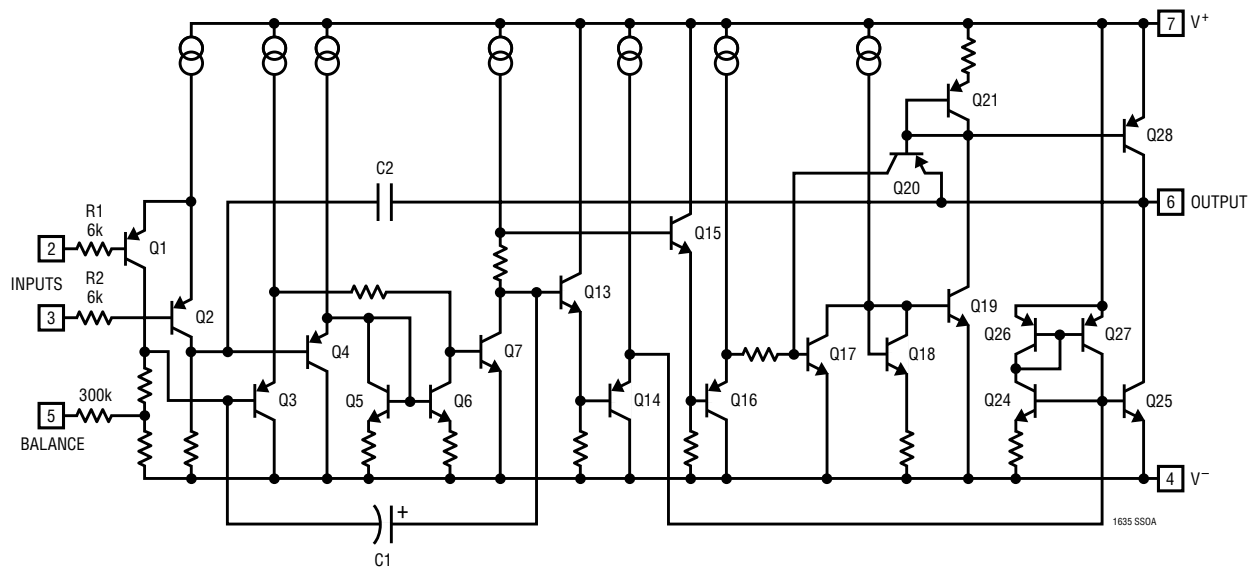

Reference

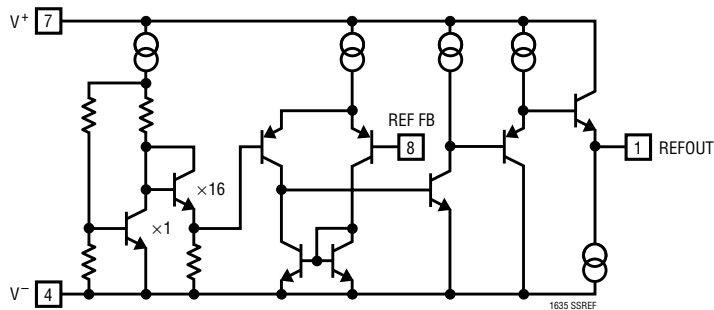

PACKAGE DESCRIPTION

N8 Package
8-Lead PDIP (Narrow .300 Inch)
 (Reference LTC DWG # 05-08-1510)

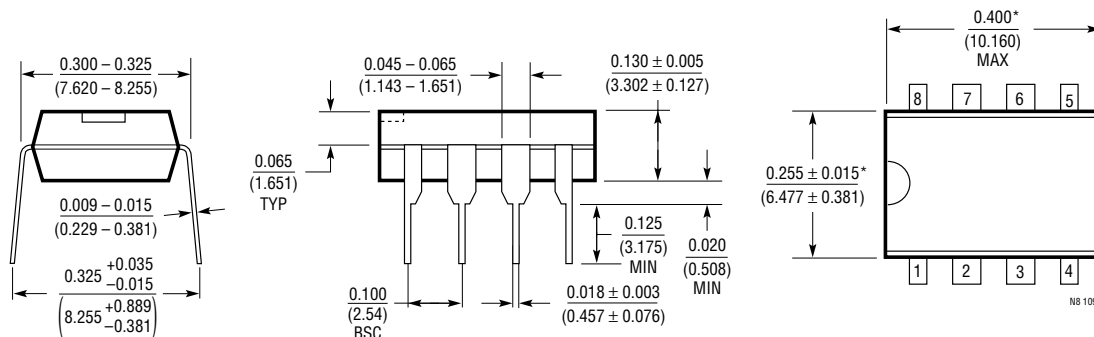

*THESE DIMENSIONS DO NOT INCLUDE MOLD FLASH OR PROTRUSIONS.
 MOLD FLASH OR PROTRUSIONS SHALL NOT EXCEED 0.010 INCH (0.254mm)

TYPICAL APPLICATION

1A Shunt Battery Charger ($I_{DARK} = 230\mu A$, $V_{FLOAT} = 14V$)

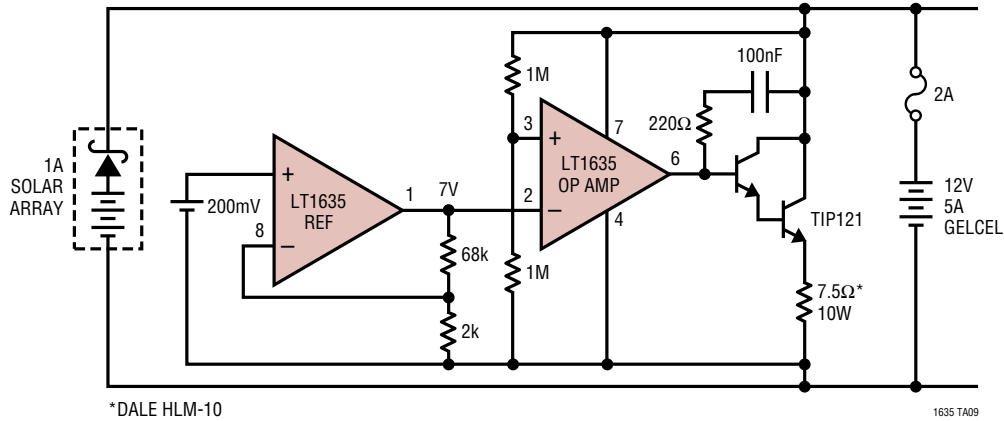

*DALE HLM-10

1635 TA09

PACKAGE DESCRIPTION

S8 Package
8-Lead Plastic Small Outline (Narrow .150 Inch)
 (Reference LTC DWG # 05-08-1610)

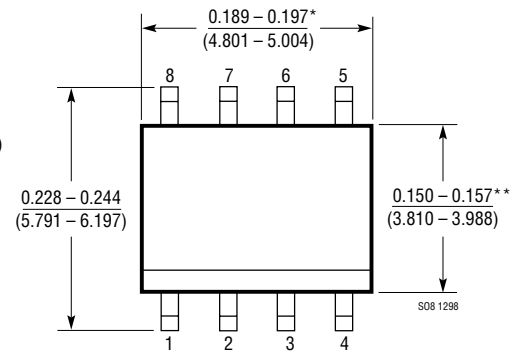
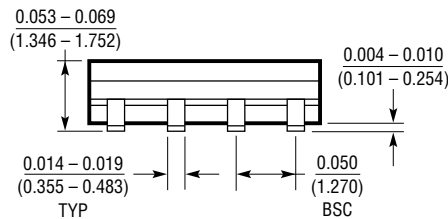
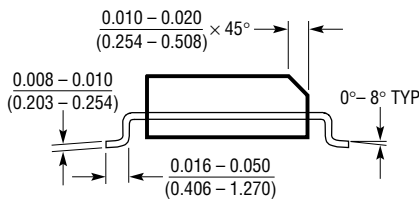

*DIMENSION DOES NOT INCLUDE MOLD FLASH. MOLD FLASH SHALL NOT EXCEED 0.006" (0.152mm) PER SIDE

**DIMENSION DOES NOT INCLUDE INTERLEAD FLASH. INTERLEAD FLASH SHALL NOT EXCEED 0.010" (0.254mm) PER SIDE

RELATED PARTS

PART NUMBER	DESCRIPTION	COMMENTS
LT1178/LT1179	Dual/Quad 17μA Max, Single Supply Precision Op Amps	70μV V_{OS} Max and 2.5μV/°C Drift Max, 85kHz GBW, 0.04V/μs Slew Rate, Input/Output Common Mode Includes Ground
LT1490A/LT1491A	Dual/Quad Micropower Rail-to-Rail Input and Output Op Amps	Single Supply Input Range: -0.4V to 44V, Micropower 50μA Amplifier, Rail-to-Rail Input and Output, 200kHz GBW
LT2178/LT2179	Dual/Quad 17μA Max, Single Supply Precision Op Amps	SO-8 and 14-Lead Standard Pinout, 70μV V_{OS} Max, 85kHz GBW
LT1078/LT1079	Dual/Quad Micropower, Single Supply Precision Op Amps	70μV V_{OS} Max and 0.4μV/°C Drift, 200kHz GBW, 0.07V/μs Slew Rate, Input/Output Common Mode Includes Ground
LT2078/LT2079	Dual/Quad Micropower, Single Supply Precision Op Amps	SO-8 and 14-Lead Standard Pinout, 70μV V_{OS} Max, 200kHz GBW