

Ordering Information

Part Number	Package Options	Packing
HV9123NG-G	16-Lead SOIC	45/Tube
HV9123NG-G M901	16-Lead SOIC	1000/Reel
HV9123NG-G M934	16-Lead SOIC	2500/Reel
HV9123P-G	16-Lead PDIP	24/Tube
HV9123PJ-G	20-Lead PLCC*	48/Tube
HV9123PJ-G M910	20-Lead PLCC*	1000/Reel

-G denotes a lead (Pb)-free / RoHS compliant package

* Obsolescence notice issued for the product in the 20-Lead PLCC package.

Absolute Maximum Ratings

Parameter	Value
Input voltage, V_{IN}	450V
Device supply voltage, V_{DD}	15.5V
Logic input voltage	-0.3V to V_{DD} +0.3V
Linear input voltage	-0.3V to V_{DD} +0.3V
Preregulator input current, I_{IN} (continuous)	2.5mA
Operating temperature range	-55°C to +125°C
Storage temperature range	-65°C to +150°C
Power dissipation:	
16-Lead SOIC	900mW
16-Lead PDIP	1000mW
20-Lead PLCC	1400mW

Stresses beyond those listed under "Absolute Maximum Ratings" may cause permanent damage to the device. These are stress ratings only, and functional operation of the device at these or any other conditions beyond those indicated in the operational sections of the specifications is not implied. Exposure to absolute maximum rating conditions for extended periods may affect device reliability.

Typical Thermal Resistance

Package	θ_{ja}
16-Lead SOIC	83°C/W
16-Lead PDIP	51°C/W
20-Lead PLCC	66°C/W

Pin Configurations

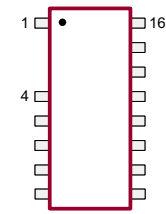

16-Lead SOIC

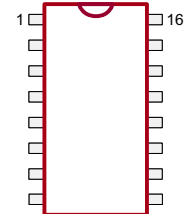

16-Lead PDIP

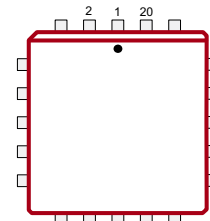

20-Lead PLCC

Product Marking

Top Marking

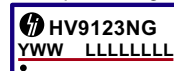

Y = Last Digit of Year Sealed
 WW = Week Sealed
 L = Lot Number
 C = Country of Origin*
 A = Assembler ID*

Bottom Marking

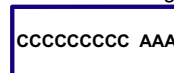

— = "Green" Packaging
 *May be part of top marking

Package may or may not include the following marks: Si or

16-Lead SOIC

Top Marking



Y = Last Digit of Year Sealed
 WW = Week Sealed
 L = Lot Number
 C = Country of Origin*
 A = Assembler ID*

Bottom Marking

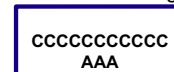

— = "Green" Packaging
 *May be part of top marking

Package may or may not include the following marks: Si or

16-Lead PDIP

Top Marking



YY = Year Sealed
 WW = Week Sealed
 L = Lot Number
 A = Assembler ID

Bottom Marking

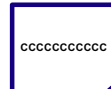

C = Country of Origin*
 — = "Green" Packaging
 *May be part of top marking

Package may or may not include the following marks: Si or

20-Lead PLCC

Electrical Characteristics

(Unless otherwise specified, $V_{DD} = 10V$, $+V_{IN} = 48V$, Discharge = $-V_{IN} = 0V$, $R_{BIAS} = 390k\Omega$, $R_{OSC} = 330k\Omega$, $T_A = 25^\circ C$.)

Sym	Parameter	#	Min	Typ	Max	Units	Conditions
-----	-----------	---	-----	-----	-----	-------	------------

Reference

V_{REF}	Output voltage	-	3.92	4.00	4.08	V	$R_L = 10M\Omega$
			3.84	4.00	4.16		$R_L = 10M\Omega$, $T_A = -55^\circ C$ to $125^\circ C$
Z_{OUT}	Output impedance	#	15	30	45	k Ω	---
I_{SHORT}	Short circuit current	-	-	125	250	μA	$V_{REF} = -V_{IN}$
ΔV_{REF}	Change in V_{REF} with temperature	#	-	0.25	-	mV/ $^\circ C$	$T_A = -55^\circ C$ to $125^\circ C$

Oscillator

f_{MAX}	Oscillator frequency	-	1.0	3.0	-	MHz	$R_{OSC} = 0\Omega$
f_{OSC}	Initial accuracy ¹	-	80	100	120	kHz	$R_{OSC} = 330k\Omega$
		-	160	200	240		$R_{OSC} = 150k\Omega$
ΔV_{OSC}	Voltage stability	-	-	-	15	%	$9.5V < V_{DD} < 13.5V$
TC_{OSC}	Temperature coefficient	#	-	170	-	ppm/ $^\circ C$	$T_A = -55^\circ C$ to $125^\circ C$

PWM

D_{MAX}	Maximum duty cycle	#	95	97	99	%	---
D_{MIN}	Deadtime	#	-	225	-	ns	---
	Minimum duty cycle	-	-	-	0	%	---
	Maximum pulse width before pulse drops out	#	-	80	125	ns	---

Current Limit

V_{LIM}	Maximum input signal	-	1.0	1.2	1.4	V	$V_{FB} = 0V$
t_D	Delay to output	#	-	80	120	ns	$V_{SENSE} = 1.5V$, $V_{COMP} \leq 2.0V$

Error Amplifier

V_{FB}	Feedback voltage	-	3.92	4.00	4.08	V	V_{FB} shorted to COMP
I_{IN}	Input bias current	-	-	25	500	nA	$V_{FB} = 4.0V$
V_{OS}	Input offset voltage	-	nulled during trim			-	---
A_{VOL}	Open loop voltage gain	#	60	80	-	dB	---
GB	Unity gain bandwidth	#	1.0	1.3	-	MHz	---
Z_{OUT}	Out impedance	#	see Fig. 1			Ω	---
I_{SOURCE}	Output source current	-	-1.4	-2.0	-	mA	$V_{FB} = 3.4V$
I_{SINK}	Output sink current	-	0.12	0.15	-	mA	$V_{FB} = 4.5V$
PSRR	Power supply rejection	#	see Fig. 2			dB	---

Notes:

Guaranteed by design.

1. Stray capacitance on OSC In pin must be $\leq 5pF$.

Electrical Characteristics (cont.)(Unless otherwise specified, $V_{DD} = 10V$, $+V_{IN} = 48V$, Discharge = $-V_{IN} = 0V$, $R_{BIAS} = 390k\Omega$, $R_{OSC} = 330k\Omega$, $T_A = 25^\circ C$.)

Sym	Parameter	#	Min	Typ	Max	Units	Conditions
-----	-----------	---	-----	-----	-----	-------	------------

Pre-regulator/Startup

$+V_{IN}$	Input voltage	-	10	-	450	V	$I_{IN} < 10\mu A$; $V_{CC} > 9.4V$
$+I_{IN}$	Input leakage current	-	-	-	10	μA	$V_{DD} > 9.4V$
V_{TH}	V_{DD} pre-regulator turn-off threshold voltage	-	8.0	8.7	9.4	V	$I_{PREREG} = 10\mu A$
V_{LOCK}	Undervoltage lockout	-	7.0	8.1	8.9	V	---

Supply

I_{DD}	Supply current	-	-	0.75	1.3	mA	$C_L < 75pF$
I_Q	Quiescent supply current	-	-	0.55	-	mA	$\overline{SHUTDOWN} = -V_{IN}$
I_{BIAS}	Nominal bias current	-	-	20	-	μA	---
V_{DD}	Operating range	-	9.0	-	13.5	V	---

Shutdown Logic

t_{SD}	$\overline{SHUTDOWN}$ delay	#	-	50	100	ns	$C_L = 500pF$, $V_{SENSE} = -V_{IN}$
t_{SW}	$\overline{SHUTDOWN}$ pulse width	#	50	-	-	ns	---
t_{RW}	RESET pulse width	#	50	-	-	ns	---
t_{LW}	Latching pulse width	#	25	-	-	ns	$\overline{SHUTDOWN}$ and RESET low
V_{IL}	Input low voltage	-	-	-	2.0	V	---
V_{IH}	Input high voltage	-	7.0	-	-	V	---
I_{IH}	Input current, input high voltage	-	-	1.0	5.0	μA	$V_{IN} = V_{DD}$
I_{IL}	Input current, input low voltage	-	-	-25	-35	μA	$V_{IN} = 0V$

Output

V_{OH}	Output high voltage	-	$V_{DD} - 0.25$	-	-	V	$I_{OUT} = 10mA$	
		-	$V_{DD} - 0.3$	-	-	V	$I_{OUT} = 10mA$, $T_A = -55^\circ C$ to $125^\circ C$	
V_{OL}	Output low voltage	-	-	-	0.2	V	$I_{OUT} = -10mA$	
		-	-	-	0.3	V	$I_{OUT} = -10mA$, $T_A = -55^\circ C$ to $125^\circ C$	
R_{OUT}	Output resistance	Pull up	-	-	15	25	Ω	$I_{OUT} = \pm 10mA$
		Pull down	-	-	8.0	20	Ω	
		Pull up	-	-	20	30	Ω	$I_{OUT} = \pm 10mA$, $T_A = -55^\circ C$ to $125^\circ C$
		Pull down	-	-	10	30	Ω	
t_R	Rise time	#	-	30	75	ns	$C_L = 500pF$	
t_F	Fall time	#	-	20	75	ns	$C_L = 500pF$	

Note:

Guaranteed by design.

Test Circuits

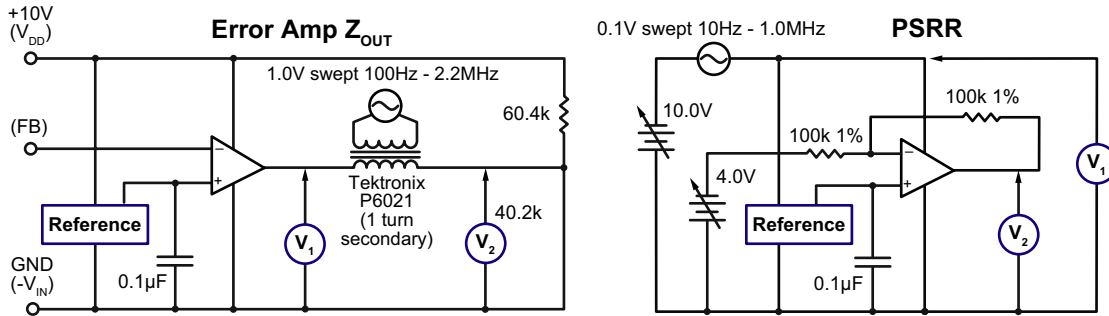

Note:

Set feedback voltage so that $V_{COMP} = V_{DIVIDE} \pm 1.0mV$ before connecting transformer.

Detailed Description

Preregulator

The preregulator/startup circuit for the HV9123 consists of a high-voltage n-channel depletion-mode DMOS transistor driven by an error amplifier to form a variable current path between the VIN terminal and the VDD terminal. Maximum current (about 20 mA) occurs when $V_{DD} = 0$, with current reducing as V_{DD} rises. This path shuts off altogether when V_{DD} rises to somewhere between 7.8 and 9.4V, so that if V_{DD} is held at 10 or 12V by an external source (generally the supply the chip is controlling), no current other than leakage is drawn through the high voltage transistor. This minimizes dissipation.

An external capacitor between VDD and VSS is generally required to store energy used by the chip in the time between shutoff of the high voltage path and the VDD supply's output rising enough to take over powering the chip. This capacitor should have a value of 100X or more the effective gate capacitance of the MOSFET being driven, i.e.,

$$C_{STORAGE} \geq 100 \times (\text{gate charge of FET at } 10V)$$

as well as very good high frequency characteristics. Stacked polyester or ceramic caps work well. Electrolytic capacitors are generally not suitable. A common resistor divider string is used to monitor V_{DD} for both the undervoltage lockout circuit and the shutoff circuit of the high voltage FET. Setting the undervoltage sense point about 0.6V lower on the string than the FET shutoff point guarantees that the undervoltage lockout always releases before the FET shuts off.

Bias Circuit

An external bias resistor, connected between the bias pin and VSS is required by the HV9123 to set currents in a series of current mirrors used by the analog sections of the chip. Nominal external bias current requirement is 15 to

20µA, which can be set by a 390 to 510kΩ resistor if a 10V V_{DD} is used, or a 510 to 680kΩ resistor if V_{DD} will be 12V. A precision resistor is not required; ±5% is fine.

Clock Oscillator

The clock oscillator of the HV9123 consists of a ring of CMOS inverters, timing capacitors, and a capacitor discharge FET. A single external resistor between the OSC IN and OSC OUT pins is required to set oscillator frequency (see graph). The discharge can either be connected to VSS directly or connected to VSS through a resistor used to set a dead time.

One difference exists between the Supertex HV9123 and competitive 9123s: The oscillator is shut off when a shutoff command is received. This saves about 150µA of quiescent current, which aids in the construction of power supplies to meet CCITT specification I-430, and in other situations where an absolute minimum of quiescent power dissipation is required.

Reference

The Reference of the HV9123 consists of a stable bandgap reference followed by a buffer amplifier which scales the voltage up to approximately 4.0V. The scaling resistors of the reference buffer amplifier are trimmed during manufacture so that the output of the error amplifier, when connected in a gain of -1 configuration, is as close to 4.0V as possible. This nulls out any input offset of the error amplifier. As a consequence, even though the observed reference voltage of a specific part may not be exactly 4.0V, the feedback voltage required for proper regulation will be.

A ≈ 50kΩ resistor is placed internally between the output of the reference buffer amplifier and the circuitry it feeds (reference output pin and non-inverting input to the error

amplifier). This allows overriding the internal reference with a low-impedance voltage source $\leq 6.0V$. Using an external reference reinstates the input offset voltage of the error amplifier, and its effect of the exact value of feedback voltage required. In general, because the reference voltage of the Supertex HV9123 is not noisy, as some previous examples have been, overriding the reference should seldom be necessary.

Because the reference of the HV9123 is a high impedance node, and usually there will be significant electrical noise near it, a bypass capacitor between the reference pin and VSS is strongly recommended. The reference buffer amplifier is intentionally compensated to be stable with a capacitive load of 0.01 to 0.1 μF .

Error Amplifier

The error amplifier in the HV9123 is a true low-power differential input operational amplifier intended for around-the-amplifier compensation. It is of mixed CMOS-bipolar construction: A PMOS input stage is used so the common-mode range includes ground and the input impedance is very high. This is followed by bipolar gain stages which provide high gain without the electrical noise of all-MOS amplifiers. The

amplifier is unity-gain stable.

Current Sense Comparators

The HV9123 uses a true dual-comparator system with independent comparators for modulation and current limiting. This allows the designer greater latitude in compensation design, as there are no clamps (except ESD protection) on the compensation pin. Like the error amplifier, the comparators are of low-noise BiCMOS construction.

Remote Shutdown

The SHUTDOWN and RESET pins of the HV9123 can be used to perform either latching or non-latching shutdown of a converter as required. These pins have internal current source pull-ups so they can be driven from open-drain logic. When not used, they should be left open, or connected to VDD.

Output Buffer

The output buffer of the HV9123 is of standard CMOS construction (P-channel pull-up, N-channel pull-down). Thus the body-drain diodes of the output stage can be used for spike clipping if necessary, and external Schottky diode clamping of the output is not required.

Truth Table

SHUTDOWN	RESET	Output
H	H	Normal operation
H	H \rightarrow L	Normal operation, no change
L	H	Off, not latched
L	L	Off, latched
L \rightarrow H	L	Off, latched, no change

Shutdown Timing Waveforms

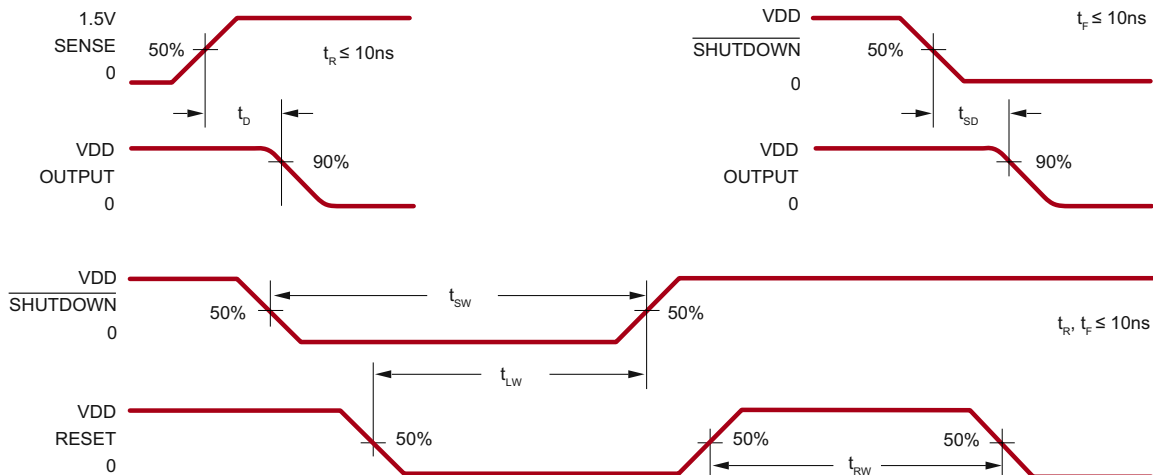

Typical Performance Curves

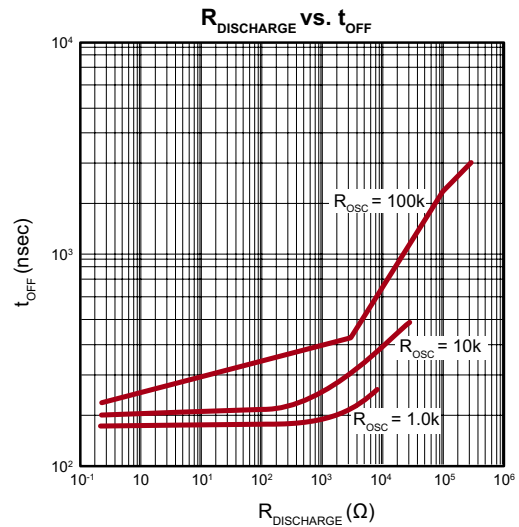
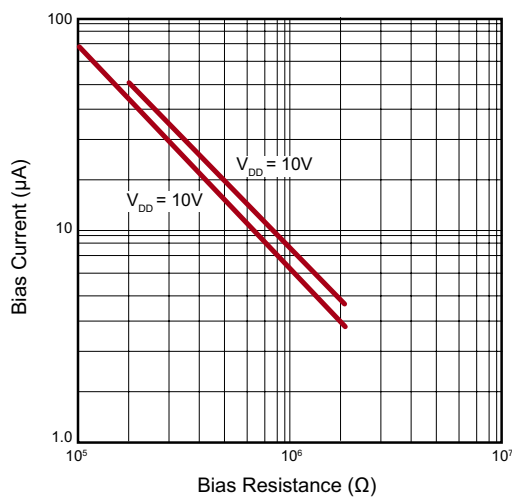
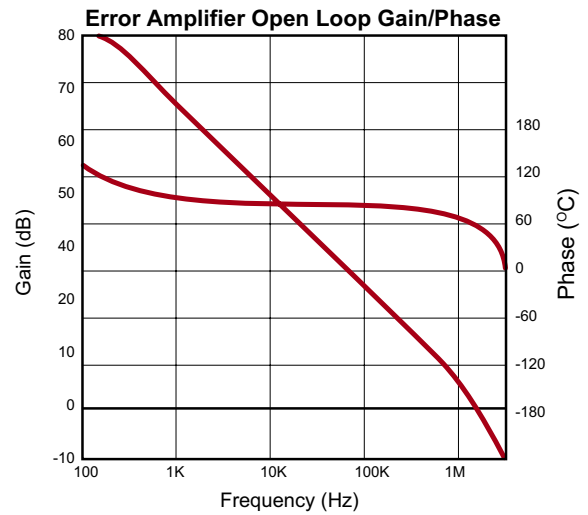
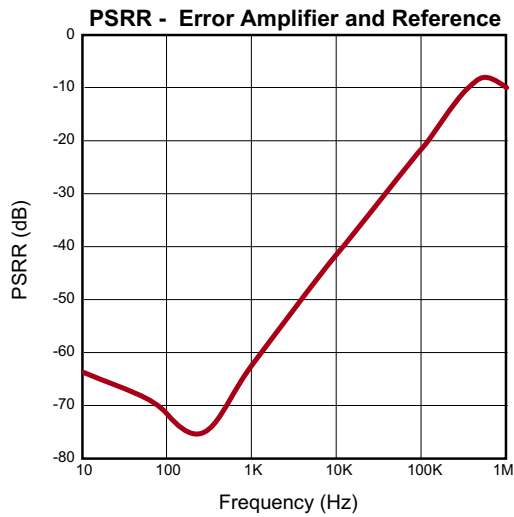
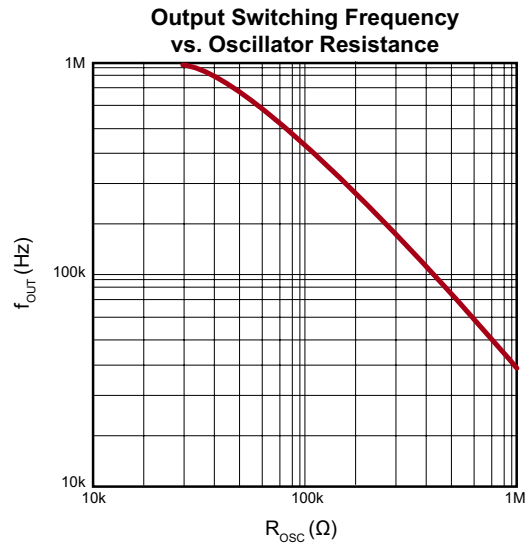
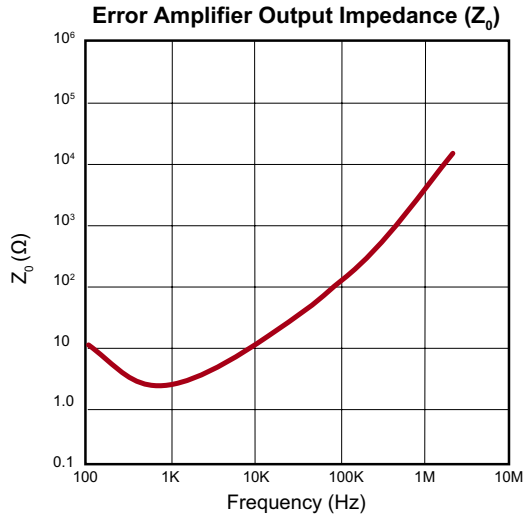

Pin Description 16-Lead SOIC (NG)

Pin #	Description
1	+VIN
-	-
-	-
4	SENSE
5	OUTPUT
6	-VIN
7	VDD
8	OSC OUT

Pin #	Description
9	OSC IN
10	DISCHARGE
11	VREF
12	$\overline{\text{SHUTDOWN}}$
13	RESET
14	COMP
15	FB
16	BIAS

Pin Description 16-Lead PDIP (P)

Pin #	Description
1	+VIN
2	NC
3	NC
4	SENSE
5	OUTPUT
6	-VIN
7	VDD
8	OSC OUT

Pin #	Description
9	OSC IN
10	DISCHARGE
11	VREF
12	$\overline{\text{SHUTDOWN}}$
13	RESET
14	COMP
15	FB
16	BIAS

Pin Description 20-Lead PLCC (PJ)

Pin #	Description
1	NC
2	NC
3	+VIN
4	NC
5	SENSE
6	OUTPUT
7	NC
8	-VIN
9	VDD
10	OSC OUT

Pin #	Description
11	OSC IN
12	DISCHARGE
13	NC
14	VREF
15	NC
16	$\overline{\text{SHUTDOWN}}$
17	RESET
18	COMP
19	FB
20	BIAS

16-Lead SOIC (Narrow Body) Package Outline (NG)

9.90x3.90mm body, 1.75mm height (max), 1.27mm pitch

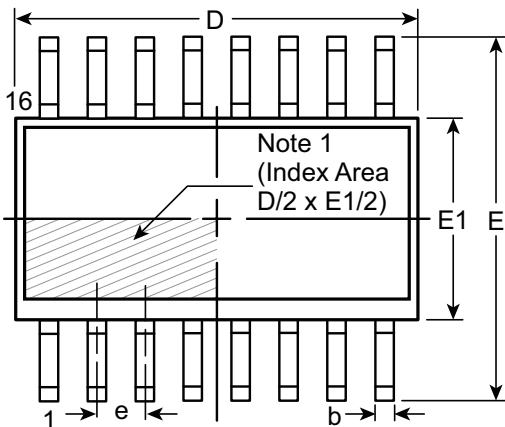

Top View

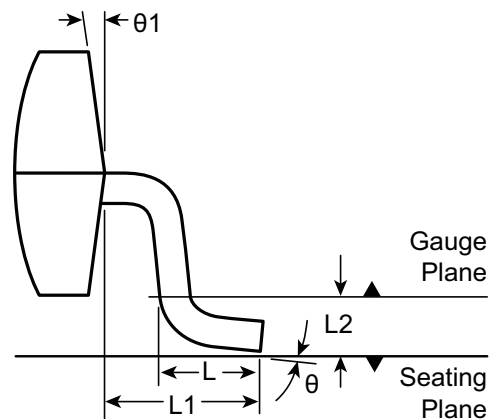

View B

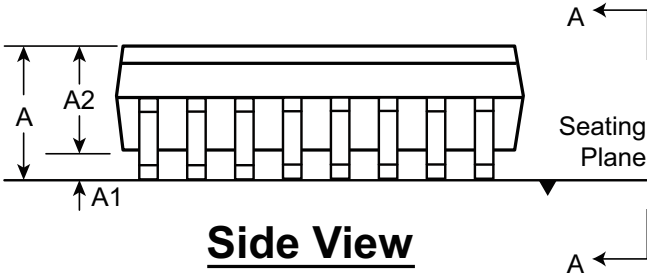

Side View

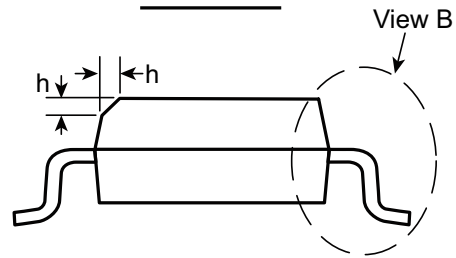

View A-A

Note:
 1. This chamfer feature is optional. If it is not present, then a Pin 1 identifier must be located in the index area indicated. The Pin 1 identifier can be: a molded mark/identifier; an embedded metal marker; or a printed indicator.

Symbol	A	A1	A2	b	D	E	E1	e	h	L	L1	L2	θ	θ1		
Dimension (mm)	MIN	1.35*	0.10	1.25	0.31	9.80*	5.80*	3.80*	1.27 BSC	0.25	0.40	1.04 REF	0.25 BSC	0°	5°	
	NOM	-	-	-	-	9.90	6.00	3.90		-	-		-	-	-	-
	MAX	1.75	0.25	1.65*	0.51	10.00*	6.20*	4.00*		0.50	1.27		-	-	8°	15°

JEDEC Registration MS-012, Variation AC, Issue E, Sept. 2005.

* This dimension is not specified in the JEDEC drawing.

Drawings are not to scale.

Supertex Doc. #: DSPD-16SONG, Version G041309.

16-Lead PDIP (.300in Row Spacing) Package Outline (P)

.790x.250in body, .210in height (max), .100in pitch

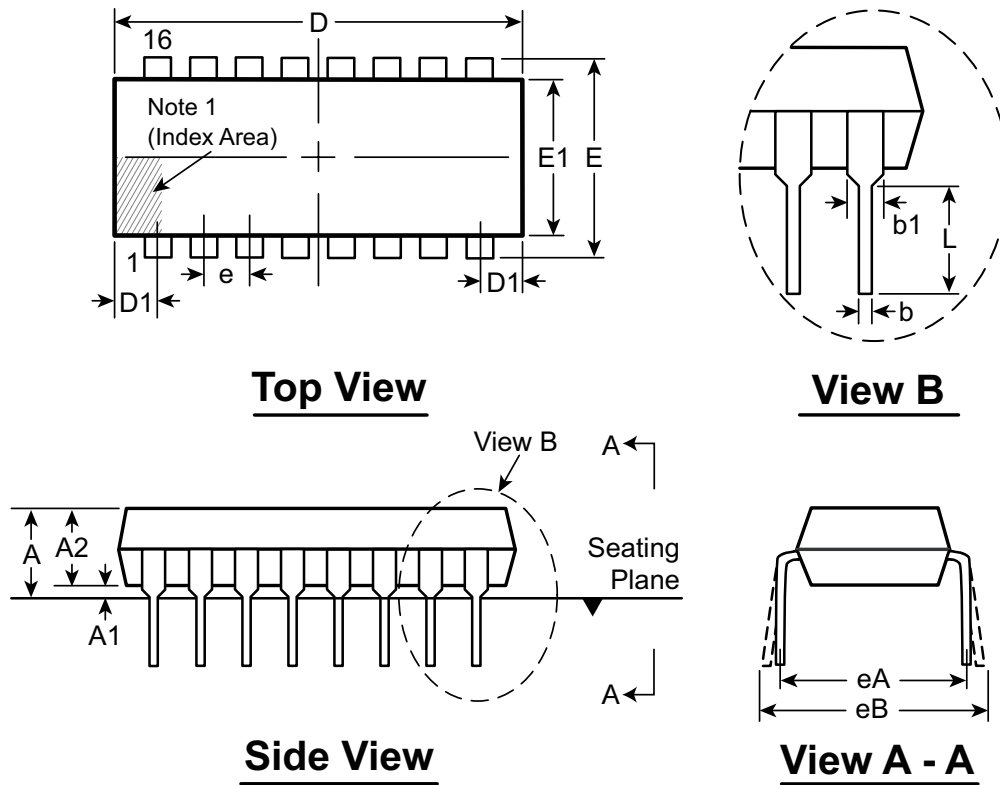

Note:
 1. A Pin 1 identifier must be located in the index area indicated. The Pin 1 identifier can be: a molded mark/identifier; an embedded metal marker; or a printed indicator.

Symbol	A	A1	A2	b	b1	D	D1	E	E1	e	eA	eB	L	
Dimension (inches)	MIN	.130*	.015	.115	.014	.045	.745†	.005	.290†	.240	.100 BSC	.300 BSC	.300*	.115
	NOM	-	-	.130	.018	.060	.790	-	.310	.250			-	.130
	MAX	.210	.035*	.195	.023†	.070	.810†	.050*	.325	.280			.430	.150

JEDEC Registration MS-001, Variation AB, Issue D, June, 1993.

* This dimension is not specified in the JEDEC drawing.

† This dimension differs from the JEDEC drawing.

Drawings not to scale.

Supertex Doc. #: DSPD-16DIPP, Version C021312.

20-Lead PLCC Package Outline (PJ)

.353x.353in body, .180in height (max), .050in pitch

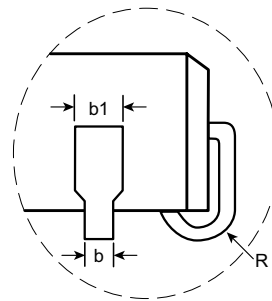
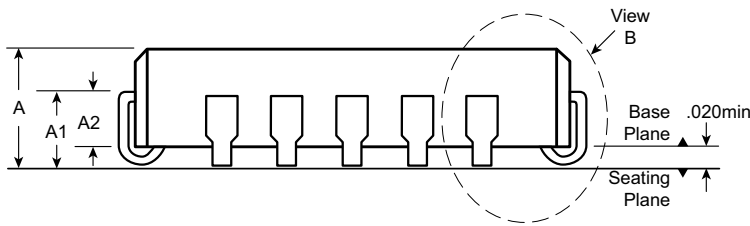
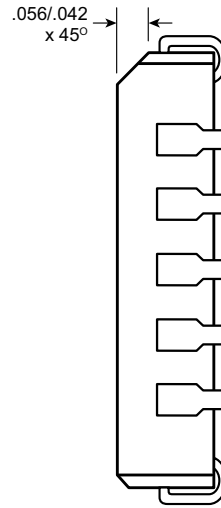
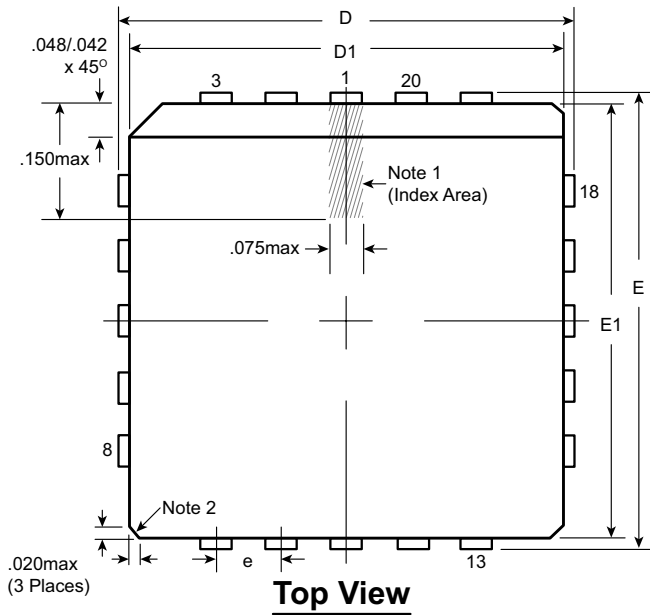

Horizontal Side View

View B

Notes:

1. A Pin 1 identifier must be located in the index area indicated. The Pin 1 identifier can be: a molded mark/identifier; an embedded metal marker; or a printed indicator.
2. Actual shape of this feature may vary.

Symbol	A	A1	A2	b	b1	D	D1	E	E1	e	R
Dimension (inches)	MIN	.165	.090	.062	.013	.385	.350	.385	.350	.050 BSC	.025
	NOM	.172	.105	-	-	.390	.353	.390	.353		.035
	MAX	.180	.120	.083	.021	.395	.356	.395	.356		.045

JEDEC Registration MS-018, Variation AA, Issue A, June, 1993.

Drawings not to scale.

Supertex Doc. #: DSPD-20PLCCPJ, Version C031111

(The package drawing(s) in this data sheet may not reflect the most current specifications. For the latest package outline information go to <http://www.supertex.com/packaging.html>.)

Supertex inc. does not recommend the use of its products in life support applications, and will not knowingly sell them for use in such applications unless it receives an adequate "product liability indemnification insurance agreement." **Supertex inc.** does not assume responsibility for use of devices described, and limits its liability to the replacement of the devices determined defective due to workmanship. No responsibility is assumed for possible omissions and inaccuracies. Circuitry and specifications are subject to change without notice. For the latest product specifications refer to the **Supertex inc.** (website: <http://www.supertex.com>)