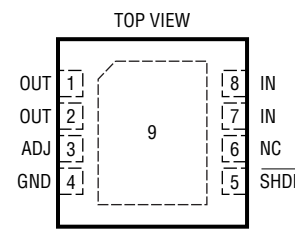
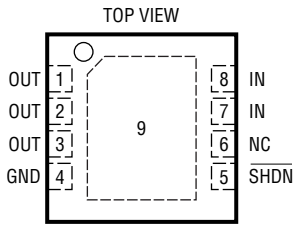
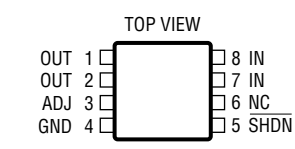
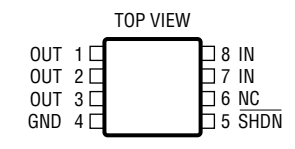

LT3020/LT3020-1.2/ LT3020-1.5/LT3020-1.8

ABSOLUTE MAXIMUM RATINGS (Note 1)

IN Pin Voltage	±10V	Operating Junction Temperature Range (Notes 2, 3)	-40°C to 125°C
OUT Pin Voltage	±10V	Storage Temperature Range	
Input-to-Output Differential Voltage	±10V	DD	-65°C to 125°C
ADJ Pin Voltage	±10V	MS8	-65°C to 150°C
SHDN Pin Voltage	±10V	Lead Temperature (Soldering, 10 sec)	300°C
Output Short-Circuit Duration	Indefinite		

PACKAGE/ORDER INFORMATION

 <p>DD PACKAGE 8-LEAD (3mm × 3mm) PLASTIC DFN</p> <p>$T_{JMAX} = 125^{\circ}\text{C}$, $\theta_{JA} = 35^{\circ}\text{C/W}^*$, $\theta_{JC} = 3^{\circ}\text{C/W}$ EXPOSED PAD IS GND (PIN 9) CONNECT TO PIN 4 *SEE THE APPLICATIONS INFORMATION SECTION</p>	ORDER PART NUMBER	 <p>DD PACKAGE 8-LEAD (3mm × 3mm) PLASTIC DFN</p> <p>$T_{JMAX} = 125^{\circ}\text{C}$, $\theta_{JA} = 35^{\circ}\text{C/W}^*$, $\theta_{JC} = 3^{\circ}\text{C/W}$ EXPOSED PAD IS GND (PIN 9) CONNECT TO PIN 4 *SEE THE APPLICATIONS INFORMATION SECTION</p>	ORDER PART NUMBER
	LT3020EDD LT3020IDD		LT3020EDD-1.2 LT3020EDD-1.5 LT3020EDD-1.8 LT3020IDD-1.2 LT3020IDD-1.5 LT3020IDD-1.8
	DD PART MARKING		DD PART MARKING
	LAEX LBYH		LBKC LBKD LBKF LBYJ LBYK LBYM
 <p>MS8 PACKAGE 8-LEAD PLASTIC MSOP</p> <p>$T_{JMAX} = 150^{\circ}\text{C}$, $\theta_{JA} = 125^{\circ}\text{C/W}$, $\theta_{JC} = 40^{\circ}\text{C/W}$ SEE THE APPLICATIONS INFORMATION SECTION</p>	ORDER PART NUMBER	 <p>MS8 PACKAGE 8-LEAD PLASTIC MSOP</p> <p>$T_{JMAX} = 150^{\circ}\text{C}$, $\theta_{JA} = 125^{\circ}\text{C/W}$, $\theta_{JC} = 40^{\circ}\text{C/W}$ SEE THE APPLICATIONS INFORMATION SECTION</p>	ORDER PART NUMBER
	LT3020EMS8 LT3020IMS8		LT3020EMS8-1.2 LT3020EMS8-1.5 LT3020EMS8-1.8 LT3020IMS8-1.2 LT3020IMS8-1.5 LT3020IMS8-1.8
	MS8 PART MARKING		MS8 PART MARKING
	LTAGL LTBYN		LTBKG LTBKH LTBKJ LTBYP LTBYQ LTBYR

Order Options Tape and Reel: Add #TR
Lead Free: Add #PBF Lead Free Tape and Reel: Add #TRPBF
Lead Free Part Marking: <http://www.linear.com/leadfree/>

Consult LTC Marketing for parts specified with wider operating temperature ranges.

ELECTRICAL CHARACTERISTICS

The ● denotes specifications which apply over the full operating temperature range, otherwise specifications are $T_J = 25^\circ\text{C}$.

PARAMETER	CONDITIONS	MIN	TYP	MAX	UNITS
Minimum Input Voltage (Note 14)	$I_{\text{LOAD}} = 100\text{mA}$, $T_J > 0^\circ\text{C}$		0.9	1.05	V
	$I_{\text{LOAD}} = 100\text{mA}$, $T_J < 0^\circ\text{C}$		0.9	1.10	V
ADJ Pin Voltage (Notes 4, 5)	$V_{\text{IN}} = 1.5\text{V}$, $I_{\text{LOAD}} = 1\text{mA}$	196	200	204	mV
	$1.15\text{V} < V_{\text{IN}} < 10\text{V}$, $1\text{mA} < I_{\text{LOAD}} < 100\text{mA}$	● 193	200	206	mV
Regulated Output Voltage (Note 4)	LT3020-1.2 $V_{\text{IN}} = 1.5\text{V}$, $I_{\text{LOAD}} = 1\text{mA}$	● 1.176	1.200	1.224	V
	$1.5\text{V} < V_{\text{IN}} < 10\text{V}$, $1\text{mA} < I_{\text{LOAD}} < 100\text{mA}$	● 1.157	1.200	1.236	V
	LT3020-1.5 $V_{\text{IN}} = 1.8\text{V}$, $I_{\text{LOAD}} = 1\text{mA}$	● 1.470	1.500	1.530	V
	$1.8\text{V} < V_{\text{IN}} < 10\text{V}$, $1\text{mA} < I_{\text{LOAD}} < 100\text{mA}$	● 1.447	1.500	1.545	V
	LT3020-1.8 $V_{\text{IN}} = 2.1\text{V}$, $I_{\text{LOAD}} = 1\text{mA}$	● 1.764	1.800	1.836	V
	$2.1\text{V} < V_{\text{IN}} < 10\text{V}$, $1\text{mA} < I_{\text{LOAD}} < 100\text{mA}$	● 1.737	1.800	1.854	V
Line Regulation (Note 6)	$\Delta V_{\text{IN}} = 1.15\text{V}$ to 10V , $I_{\text{LOAD}} = 1\text{mA}$	● -1.75	0	1.75	mV
	LT3020-1.2 $\Delta V_{\text{IN}} = 1.5\text{V}$ to 10V , $I_{\text{LOAD}} = 1\text{mA}$	● -10.5	0	10.5	mV
	LT3020-1.5 $\Delta V_{\text{IN}} = 1.8\text{V}$ to 10V , $I_{\text{LOAD}} = 1\text{mA}$	● -13	0	13	mV
	LT3020-1.8 $\Delta V_{\text{IN}} = 2.1\text{V}$ to 10V , $I_{\text{LOAD}} = 1\text{mA}$	● -15.8	0	15.8	mV
Load Regulation (Note 6)	$V_{\text{IN}} = 1.15\text{V}$, $\Delta I_{\text{LOAD}} = 1\text{mA}$ to 100mA	-1	0.4	1	mV
	LT3020-1.2 $V_{\text{IN}} = 1.5\text{V}$, $\Delta I_{\text{LOAD}} = 1\text{mA}$ to 100mA	-6	1	6	mV
	LT3020-1.5 $V_{\text{IN}} = 1.8\text{V}$, $\Delta I_{\text{LOAD}} = 1\text{mA}$ to 100mA	-7.5	1.5	7.5	mV
	LT3020-1.8 $V_{\text{IN}} = 2.1\text{V}$, $\Delta I_{\text{LOAD}} = 1\text{mA}$ to 100mA	-9	2	9	mV
Dropout Voltage (Notes 7, 12)	$I_{\text{LOAD}} = 10\text{mA}$		85	115	mV
	$I_{\text{LOAD}} = 10\text{mA}$	●		180	mV
	$I_{\text{LOAD}} = 100\text{mA}$		150	180	mV
	$I_{\text{LOAD}} = 100\text{mA}$	●		285	mV
GND Pin Current $V_{\text{IN}} = V_{\text{OUT(NOMINAL)}}$ (Notes 8, 12)	$I_{\text{LOAD}} = 0\text{mA}$	●	120	250	μA
	$I_{\text{LOAD}} = 1\text{mA}$		570		μA
	$I_{\text{LOAD}} = 10\text{mA}$		920		μA
	$I_{\text{LOAD}} = 100\text{mA}$	●	2.25	3.5	mA
Output Voltage Noise	$C_{\text{OUT}} = 2.2\mu\text{F}$, $I_{\text{LOAD}} = 100\text{mA}$, $\text{BW} = 10\text{Hz}$ to 100kHz , $V_{\text{OUT}} = 1.2\text{V}$		245		μV_{RMS}
ADJ Pin Bias Current	$V_{\text{ADJ}} = 0.2\text{V}$, $\text{RIPPLE} = 1.2\text{V}$ (Notes 6, 9)		20	50	nA
Shutdown Threshold	$V_{\text{OUT}} = \text{Off to On}$	●	0.61	0.9	V
	$V_{\text{OUT}} = \text{On to Off}$	● 0.25	0.61		V
SHDN Pin Current (Note 10)	$V_{\text{SHDN}} = 0\text{V}$, $V_{\text{IN}} = 10\text{V}$	●		± 1	μA
	$V_{\text{SHDN}} = 10\text{V}$, $V_{\text{IN}} = 10\text{V}$	●	3	9.5	μA
Quiescent Current in Shutdown	$V_{\text{IN}} = 6\text{V}$, $V_{\text{SHDN}} = 0\text{V}$		3	9	μA
Ripple Rejection (Note 6)	$V_{\text{IN}} - V_{\text{OUT}} = 1\text{V}$, $V_{\text{RIPPLE}} = 0.5\text{V}_{\text{P-P}}$, $f_{\text{RIPPLE}} = 120\text{Hz}$, $I_{\text{LOAD}} = 100\text{mA}$		64		dB
	LT3020-1.2 $V_{\text{IN}} - V_{\text{OUT}} = 1\text{V}$, $V_{\text{RIPPLE}} = 0.5\text{V}_{\text{P-P}}$, $f_{\text{RIPPLE}} = 120\text{Hz}$, $I_{\text{LOAD}} = 100\text{mA}$		60		dB
	LT3020-1.5 $V_{\text{IN}} - V_{\text{OUT}} = 1\text{V}$, $V_{\text{RIPPLE}} = 0.5\text{V}_{\text{P-P}}$, $f_{\text{RIPPLE}} = 120\text{Hz}$, $I_{\text{LOAD}} = 100\text{mA}$		58		dB
	LT3020-1.8 $V_{\text{IN}} - V_{\text{OUT}} = 1\text{V}$, $V_{\text{RIPPLE}} = 0.5\text{V}_{\text{P-P}}$, $f_{\text{RIPPLE}} = 120\text{Hz}$, $I_{\text{LOAD}} = 100\text{mA}$		56		dB

ELECTRICAL CHARACTERISTICS

The ● denotes specifications which apply over the full operating temperature range, otherwise specifications are $T_J = 25^\circ\text{C}$.

PARAMETER	CONDITIONS	MIN	TYP	MAX	UNITS
Current Limit (Note 12)	$V_{IN} = 10\text{V}, V_{OUT} = 0\text{V}$		360		mA
	$V_{IN} = V_{OUT(\text{NOMINAL})} + 0.5\text{V}, \Delta V_{OUT} = -5\%$	● 110	310		mA
Input Reverse Leakage Current	$V_{IN} = -10\text{V}, V_{OUT} = 0\text{V}$		1	10	μA
Reverse Output Current (Notes 11, 13)	$V_{OUT} = 1.2\text{V}, V_{IN} = 0\text{V}$		3	5	μA
	LT3020-1.2 $V_{OUT} = 1.2\text{V}, V_{IN} = 0\text{V}$		10	15	μA
	LT3020-1.5 $V_{OUT} = 1.5\text{V}, V_{IN} = 0\text{V}$		10	15	μA
	LT3020-1.8 $V_{OUT} = 1.8\text{V}, V_{IN} = 0\text{V}$		10	15	μA

Note 1: Absolute Maximum Ratings are those values beyond which the life of a device may be impaired.

Note 2: The LT3020 regulators are tested and specified under pulse load conditions such that $T_J \approx T_A$. The LT3020E is 100% production tested at $T_A = 25^\circ\text{C}$. Performance at -40°C and 125°C is assured by design, characterization and correlation with statistical process controls. The LT3020I is guaranteed over the full -40°C to 125°C operating junction temperature range.

Note 3: This IC includes overtemperature protection that is intended to protect the device during momentary overload conditions. Junction temperature will exceed 125°C when overtemperature protection is active. Continuous operation above the specified maximum operating junction temperature may impair device reliability.

Note 4: Maximum junction temperature limits operating conditions. The regulated output voltage specification does not apply for all possible combinations of input voltage and output current. Limit the output current range if operating at maximum input voltage. Limit the input voltage range if operating at maximum output current.

Note 5: Typically the LT3020 supplies 100mA output current with a 1V input supply. The guaranteed minimum input voltage for 100mA output current is 1.10V.

Note 6: The LT3020 is tested and specified for these conditions with an external resistor divider (20k and 30.1k) setting V_{OUT} to 0.5V. The external resistor divider adds $10\mu\text{A}$ of output load current. The line regulation and load regulation specifications refer to the change in the 0.2V reference voltage, not the 0.5V output voltage. Specifications for fixed output voltage devices are referred to the output voltage.

Note 7: Dropout voltage is the minimum input to output voltage differential needed to maintain regulation at a specified output current. In dropout the output voltage equals: $(V_{IN} - V_{\text{DROPOUT}})$.

Note 8: GND pin current is tested with $V_{IN} = V_{\text{OUT}(\text{NOMINAL})}$ and a current source load. The device is tested while operating in its dropout region. This condition forces the worst-case GND pin current. GND pin current decreases at higher input voltages.

Note 9: Adjust pin bias current flows out of the ADJ pin.

Note 10: Shutdown pin current flows into the SHDN pin.

Note 11: Reverse output current is tested with IN grounded and OUT forced to the rated output voltage. This current flows into the OUT pin and out of the GND pin. For fixed voltage devices this includes the current in the output resistor divider.

Note 12: The LT3020 is tested and specified for these conditions with an external resistor divider (20k and 100k) setting V_{OUT} to 1.2V. The external resistor divider adds $10\mu\text{A}$ of load current.

Note 13: Reverse current is higher for the case of $(\text{rated_output}) < V_{OUT} < V_{IN}$, because the no-load recovery circuitry is active in this region and is trying to restore the output voltage to its nominal value.

Note 14: Minimum input voltage is the minimum voltage required by the control circuit to regulate the output voltage and supply the full 100mA rated current. This specification is tested at $V_{OUT} = 0.5\text{V}$. At higher output voltages the minimum input voltage required for regulation will be equal to the regulated output voltage V_{OUT} plus the dropout voltage.

TYPICAL PERFORMANCE CHARACTERISTICS

Typical Dropout Voltage

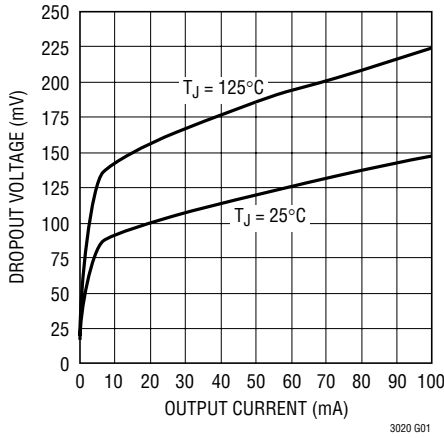

Dropout Voltage

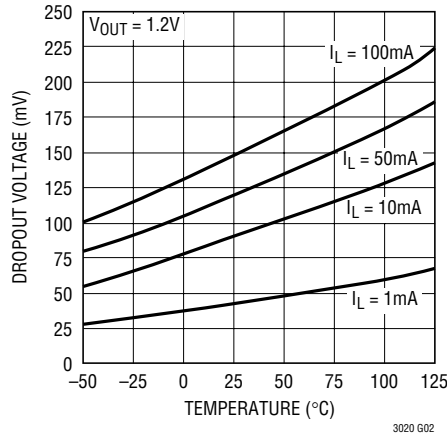

Quiescent Current

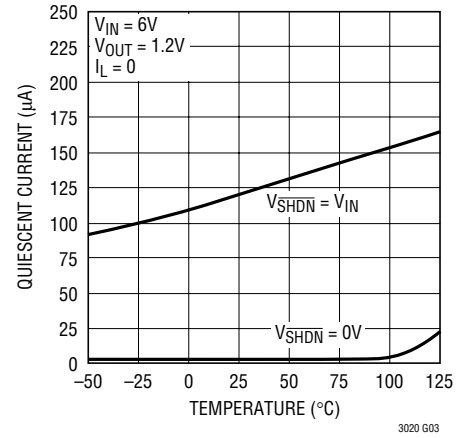

ADJ Pin Voltage

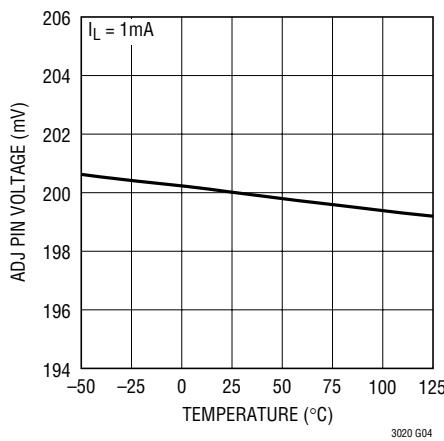

Output Voltage

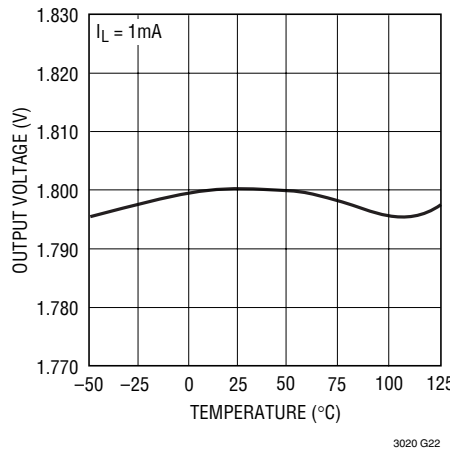

Output Voltage

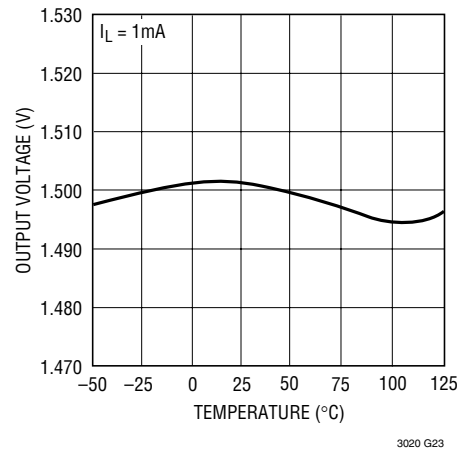

Output Voltage

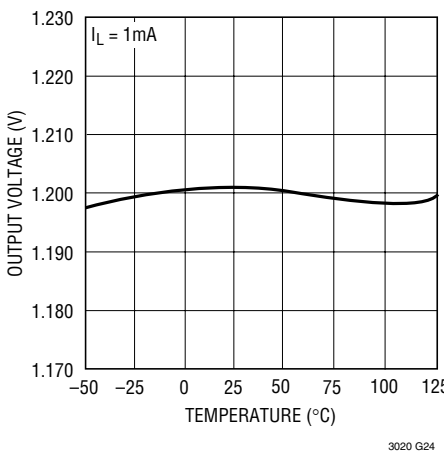

Quiescent Current

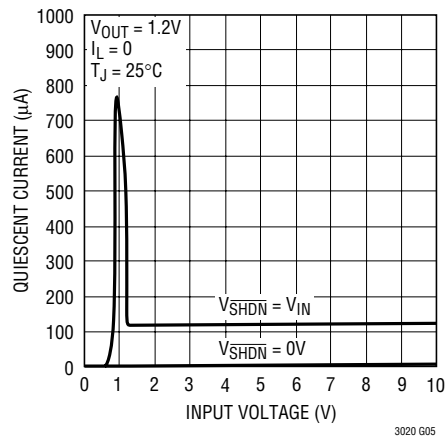

GND Pin Current

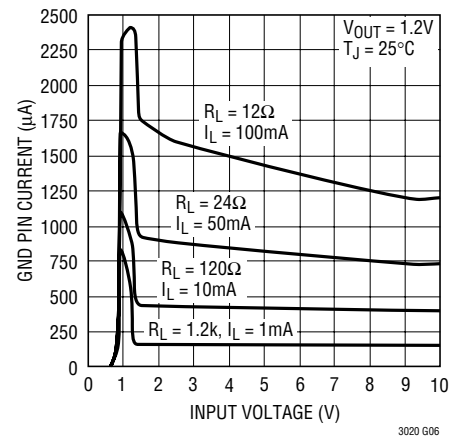

TYPICAL PERFORMANCE CHARACTERISTICS

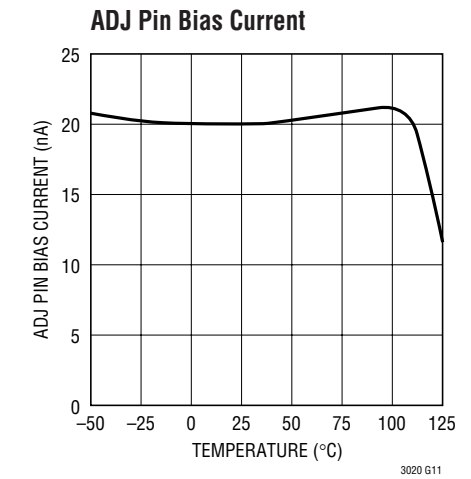
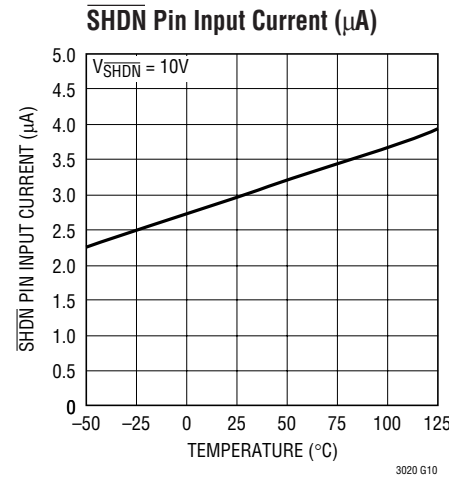
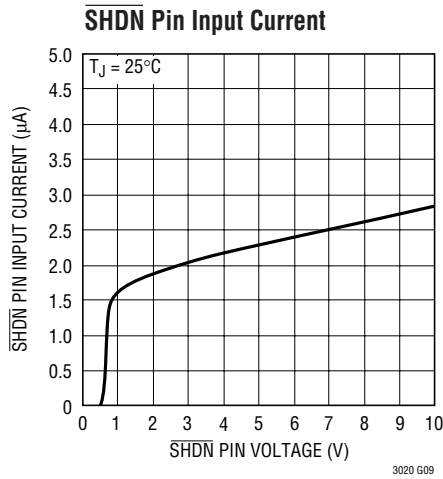
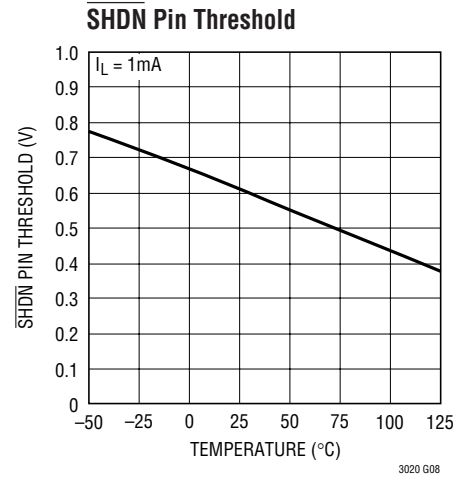
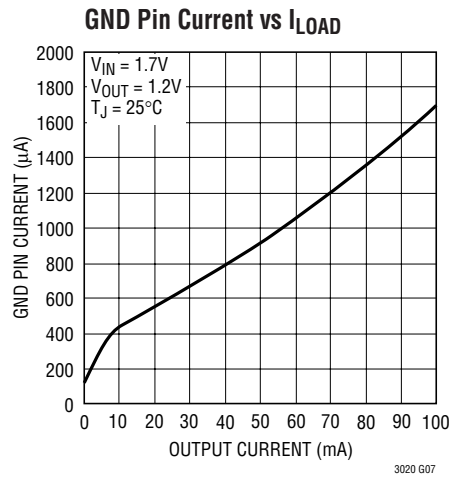
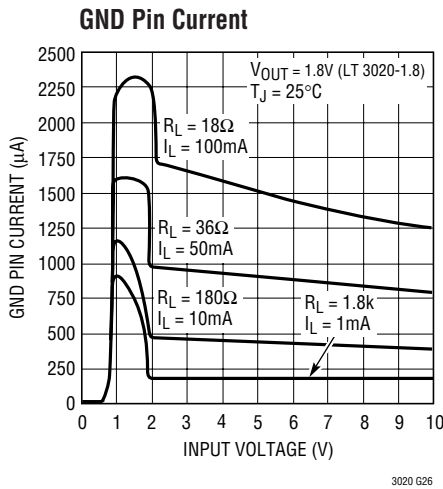
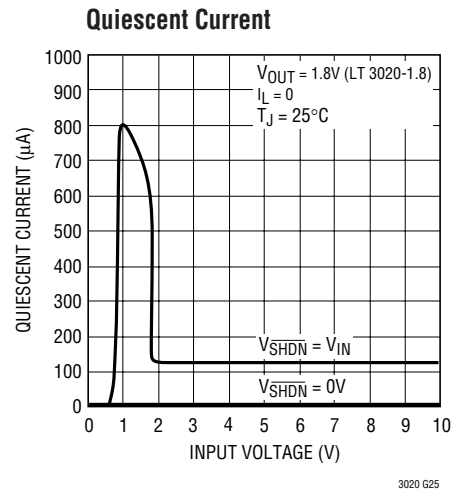
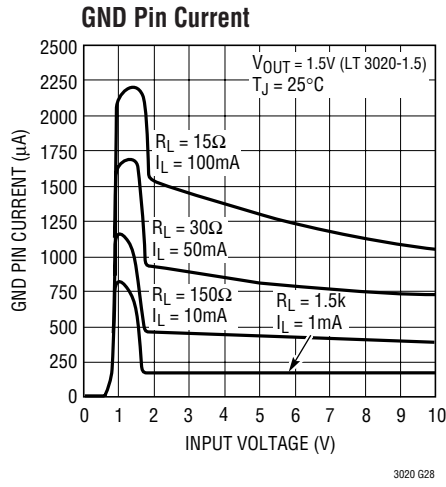
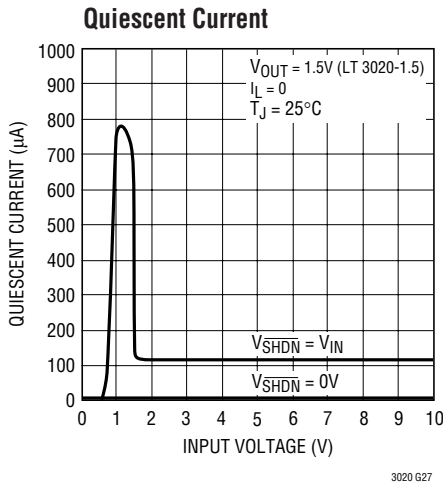

TYPICAL PERFORMANCE CHARACTERISTICS

Current Limit

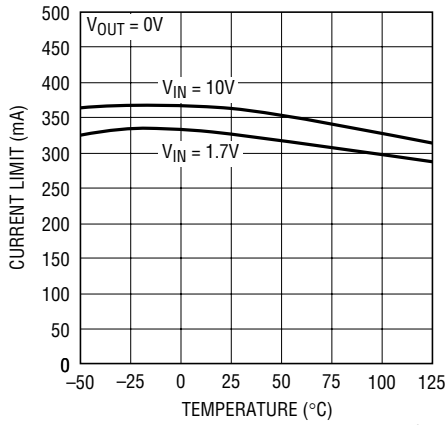

Reverse Output Current

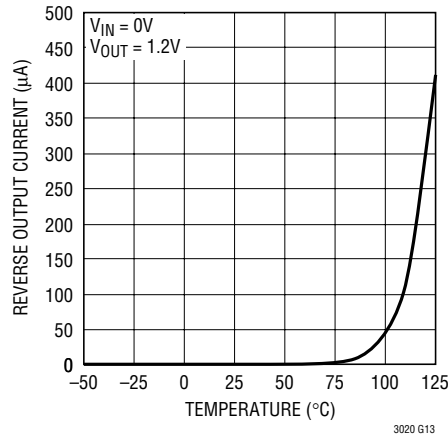

Input Ripple Rejection

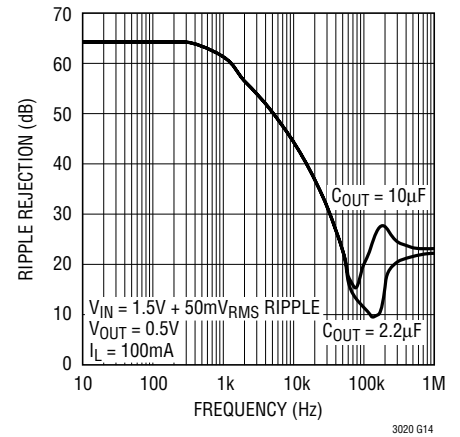

Input Ripple Rejection

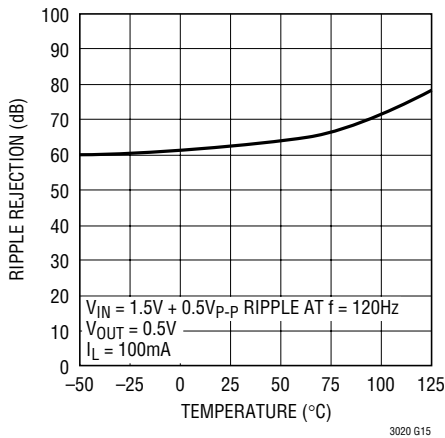

Minimum Input Voltage

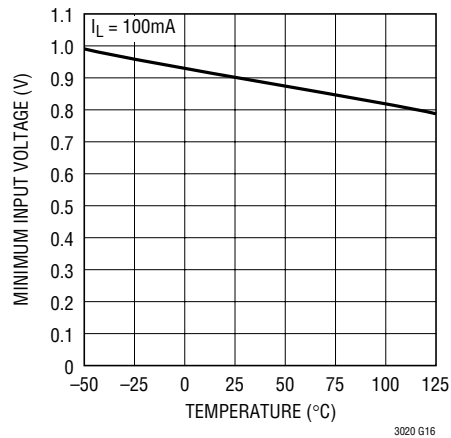

Load Regulation
 $\Delta I_L = 1mA$ to $100mA$

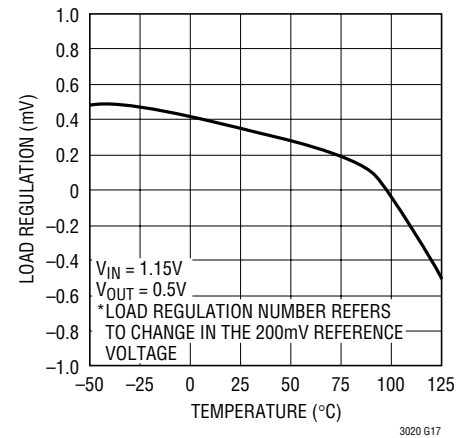

Transient Response

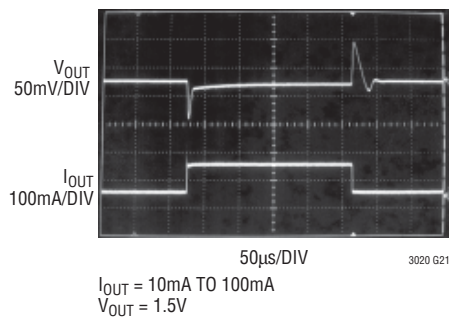

Output Noise Spectral Density

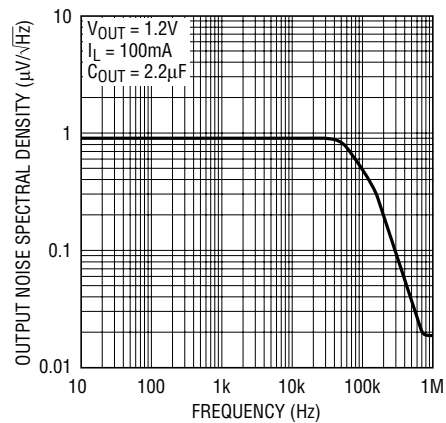

TYPICAL PERFORMANCE CHARACTERISTICS

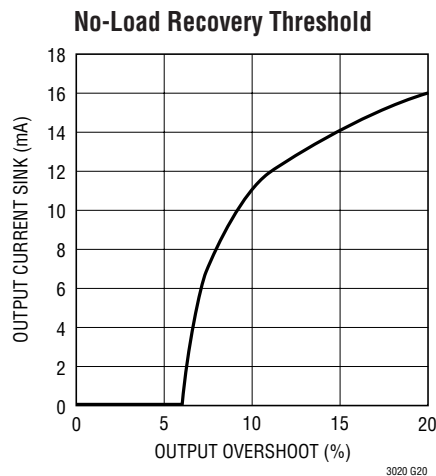
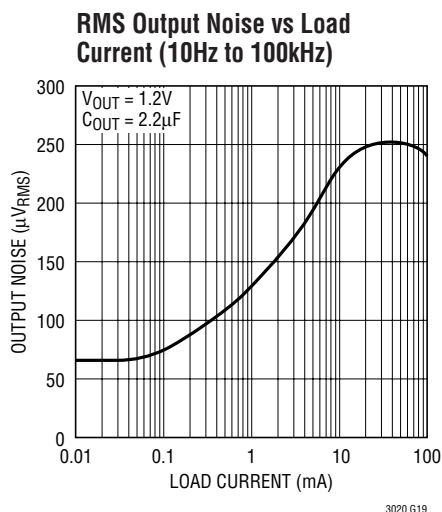

PIN FUNCTIONS

OUT (Pins 1, 2): These pins supply power to the load. Use a minimum output capacitor of 2.2µF to prevent oscillations. Applications with large load transients require larger output capacitors to limit peak voltage transients. See the Applications Information section for more information on output capacitance and reverse output characteristics.

OUT (Pin 3, Fixed Voltage Device Only): This pin is the sense point for the internal resistor divider. It should be tied directly to the other OUT pins (1, 2) for best results.

ADJ (Pin 3, Adjustable Device Only): This pin is the inverting terminal to the error amplifier. Its typical input bias current of 20nA flows out of the pin (see curve of ADJ Pin Bias Current vs Temperature in the Typical Performance Characteristics). The ADJ pin reference voltage is 200mV (referred to GND).

GND (Pin 4): Ground.

SHDN (Pin 5): The SHDN pin puts the LT3020 into a low power state. Pulling the SHDN pin low turns the output off. Drive the SHDN pin with either logic or an open collector/drain device with a pull-up resistor. The pull-up resistor

supplies the pull-up current to the open collector/drain logic, normally several microamperes, and the SHDN pin current, typically 2.3µA. If unused, connect the SHDN pin to V_{IN} . The LT3020 does not function if the SHDN pin is not connected.

IN (Pins 7, 8): These pins supply power to the device. The LT3020 requires a bypass capacitor at IN if it is more than six inches away from the main input filter capacitor. The output impedance of a battery rises with frequency, so include a bypass capacitor in battery-powered circuits. A bypass capacitor in the range of 2.2µF to 10µF suffices. The LT3020 withstands reverse voltages on the IN pin with respect to ground and the OUT pin. In the case of a reversed input, which occurs if a battery is plugged in backwards, the LT3020 acts as if a diode is in series with its input. No reverse current flows into the LT3020 and no reverse voltage appears at the load. The device protects itself and the load.

GND (Pin 9, DD8 Package Only): Ground. Solder Pin 9 (the exposed pad) to the PCB. Connect directly to Pin 4 for best performance.

BLOCK DIAGRAM

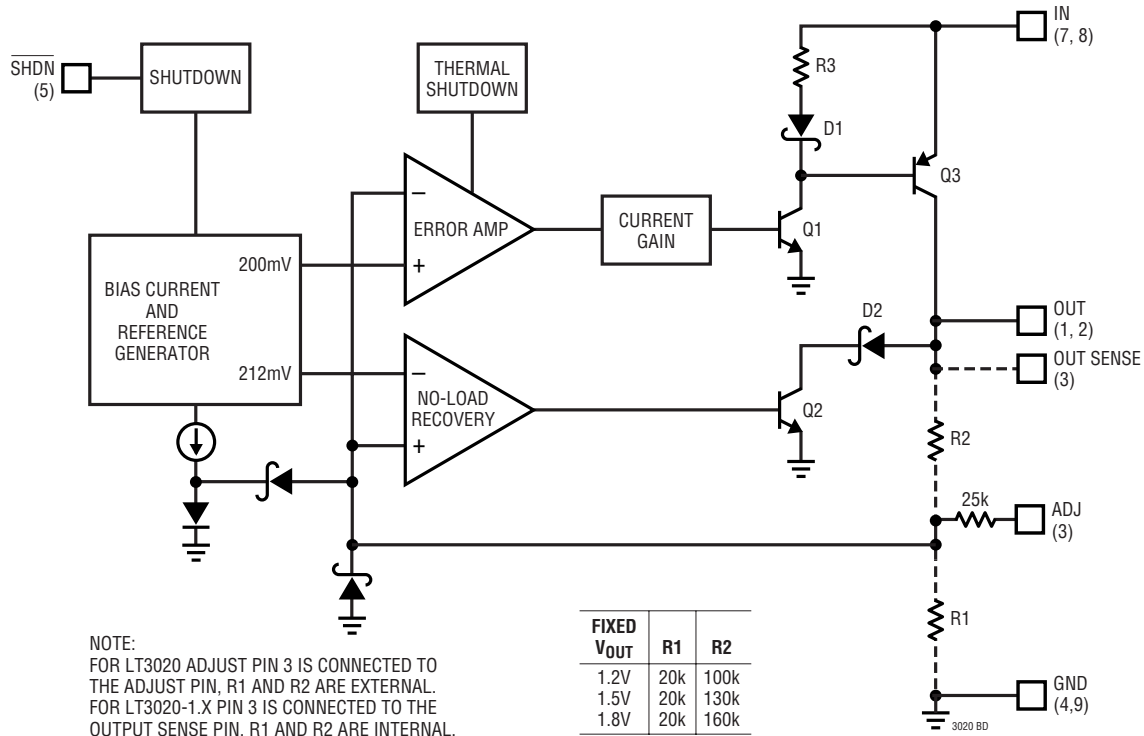

APPLICATIONS INFORMATION

The LT3020 is a very low dropout linear regulator capable of 0.9V input supply operation. Devices supply 100mA of output current and dropout voltage is typically 150mV. Quiescent current is typically 120μA and drops to 3μA in shutdown. The LT3020 incorporates several protection features, making it ideal for use in battery-powered systems. The device protects itself against reverse-input and reverse-output voltages. In battery backup applications where the output is held up by a backup battery when the input is pulled to ground, the LT3020 acts as if a diode is in series with its output which prevents reverse current flow. In dual supply applications where the regulator load is returned to a negative supply, the output can be pulled below ground by as much as 10V without affecting start-up or normal operation.

Adjustable Operation

The LT3020's output voltage range is 0.2V to 9.5V. Figure 1 shows that the output voltage is set by the ratio of two external resistors. The device regulates the output to maintain the ADJ pin voltage at 200mV referenced to ground. The current in R1 equals 200mV/R1 and the

current in R2 is the current in R1 minus the ADJ pin bias current. The ADJ pin bias current of 20nA flows out of the pin. Use the formula in Figure 1 to calculate output voltage. An R1 value of 20k sets the resistor divider current to 10μA. Note that in shutdown the output is turned off and the divider current is zero. Curves of ADJ Pin Voltage vs Temperature and ADJ Pin Bias Current vs Temperature appear in the Typical Performance Characteristics section.

Specifications for output voltages greater than 200mV are proportional to the ratio of desired output voltage to 200mV; ($V_{OUT}/200mV$). For example, load regulation for

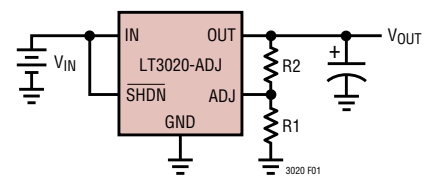

$$V_{OUT} = 200mV \left(1 + \frac{R2}{R1} \right) - I_{ADJ}(R2)$$

$$V_{ADJ} = 200mV$$

$$I_{ADJ} = 20nA \text{ AT } 25^{\circ}C$$

$$\text{OUTPUT RANGE} = 0.2V \text{ TO } 9.5V$$

Figure 1. Adjustable Operation

APPLICATIONS INFORMATION

an output current change of 1mA to 100mA is typically 0.4mV at $V_{ADJ} = 200\text{mV}$. At $V_{OUT} = 1.5\text{V}$, load regulation is:

$$(1.5\text{V}/200\text{mV}) \cdot (0.4\text{mV}) = 3\text{mV}$$

Output Capacitance and Transient Response

The LT3020's design is stable with a wide range of output capacitors, but is optimized for low ESR ceramic capacitors. The output capacitor's ESR affects stability, most notably with small value capacitors. Use a minimum output capacitor of $2.2\mu\text{F}$ with an ESR of 0.3Ω or less to prevent oscillations. The LT3020 is a low voltage device, and output load transient response is a function of output capacitance. Larger values of output capacitance decrease the peak deviations and provide improved transient response for larger load current changes. For output capacitor values greater than $20\mu\text{F}$ a small feedforward capacitor with a value of 300pF across the upper divider resistor (R_2 in Figure 1) is required.

Give extra consideration to the use of ceramic capacitors. Manufacturers make ceramic capacitors with a variety of dielectrics, each with a different behavior across temperature and applied voltage. The most common dielectrics are Z5U, Y5V, X5R and X7R. The Z5U and Y5V dielectrics provide high C-V products in a small package at low cost, but exhibit strong voltage and temperature coefficients. The X5R and X7R dielectrics yield highly stable characteristics and are more suitable for use as the output capacitor at fractionally increased cost. The X5R and X7R dielectrics both exhibit excellent voltage coefficient characteristics. The X7R type works over a larger temperature range and exhibits better temperature stability whereas X5R is less expensive and is available in higher values. Figures 2 and 3 show voltage coefficient and temperature coefficient comparisons between Y5V and X5R material.

Voltage and temperature coefficients are not the only sources of problems. Some ceramic capacitors have a piezoelectric response. A piezoelectric device generates voltage across its terminals due to mechanical stress, similar to the way a piezoelectric accelerometer or microphone works. For a ceramic capacitor, the stress can be induced by vibrations in the system or thermal transients. The resulting voltages produced can cause appreciable amounts of noise. A ceramic capacitor produced Figure 4's trace in

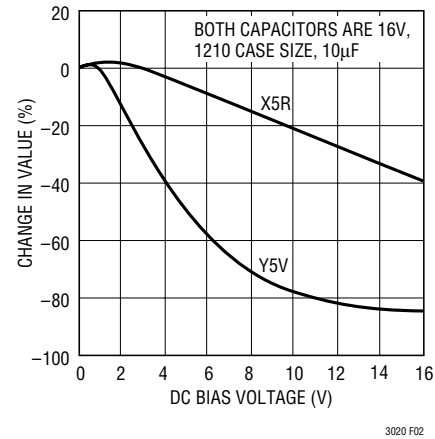

Figure 2. Ceramic Capacitor DC Bias Characteristics

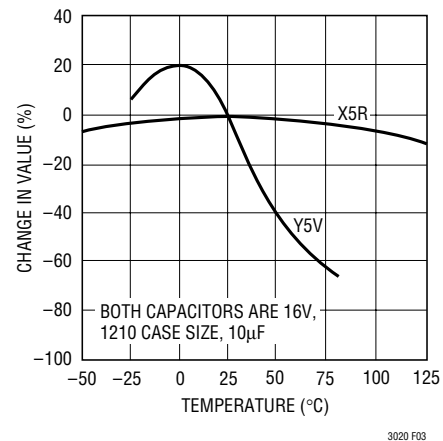

Figure 3. Ceramic Capacitor Temperature Characteristics

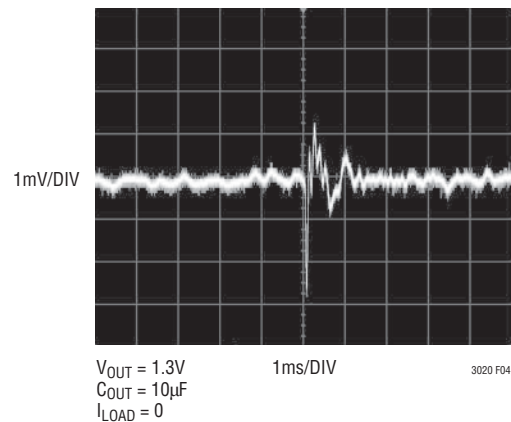

Figure 4. Noise Resulting from Tapping on a Ceramic Capacitor

APPLICATIONS INFORMATION

response to light tapping from a pencil. Similar vibration induced behavior can masquerade as increased output voltage noise.

No-Load/Light-Load Recovery

A possible transient load step that occurs is where the output current changes from its maximum level to zero current or a very small load current. The output voltage responds by overshooting until the regulator lowers the amount of current it delivers to the new level. The regulator loop response time and the amount of output capacitance control the amount of overshoot. Once the regulator has decreased its output current, the current provided by the resistor divider (which sets V_{OUT}) is the only current remaining to discharge the output capacitor from the level to which it overshoot. The amount of time it takes for the output voltage to recover easily extends to milliseconds with microamperes of divider current and a few microfarads of output capacitance.

To eliminate this problem, the LT3020 incorporates a no-load or light-load recovery circuit. This circuit is a voltage-controlled current sink that significantly improves the light load transient response time by discharging the output capacitor quickly and then turning off. The current sink turns on when the output voltage exceeds 6% of the nominal output voltage. The current sink level is then proportional to the overdrive above the threshold up to a maximum of approximately 15mA. Consult the curve in the Typical Performance Characteristics for the No-Load Recovery Threshold.

If external circuitry forces the output above the no load recovery circuit's threshold, the current sink turns on in an attempt to restore the output voltage to nominal. The current sink remains on until the external circuitry releases the output. However, if the external circuitry pulls the output voltage above the input voltage, or the input falls below the output, the LT3020 turns the current sink off and shuts down the bias current/reference generator circuitry.

Thermal Considerations

The LT3020's power handling capability is limited by its maximum rated junction temperature of 125°C. The power dissipated by the device is comprised of two components:

1. Output current multiplied by the input-to-output voltage differential: $(I_{OUT})(V_{IN} - V_{OUT})$ and
2. GND pin current multiplied by the input voltage: $(I_{GND})(V_{IN})$.

GND pin current is found by examining the GND pin current curves in the Typical Performance Characteristics. Power dissipation is equal to the sum of the two components listed above.

The LT3020 regulator has internal thermal limiting (with hysteresis) designed to protect the device during overload conditions. For normal continuous conditions, do not exceed the maximum junction temperature rating of 125°C. Carefully consider all sources of thermal resistance from junction to ambient including other heat sources mounted in proximity to the LT3020.

The underside of the LT3020 DD package has exposed metal (4mm²) from the lead frame to where the die is attached. This allows heat to directly transfer from the die junction to the printed circuit board metal to control maximum operating junction temperature. The dual-in-line pin arrangement allows metal to extend beyond the ends of the package on the topside (component side) of a PCB. Connect this metal to GND on the PCB. The multiple IN and OUT pins of the LT3020 also assist in spreading heat to the PCB.

The LT3020 MS8 package has pin 4 fused with the lead frame. This also allows heat to transfer from the die to the printed circuit board metal, therefore reducing the thermal resistance. Copper board stiffeners and plated through-holes can also be used to spread the heat generated by power devices.

The following tables list thermal resistance for several different board sizes and copper areas for two different packages. Measurements were taken in still air on 3/32" FR-4 board with one ounce copper.

Table 1. Measured Thermal Resistance for DD Package

COPPER AREA		BOARD AREA	THERMAL RESISTANCE (JUNCTION-TO-AMBIENT)
TOPSIDE*	BACKSIDE		
2500mm ²	2500mm ²	2500mm ²	35°C/W
900mm ²	2500mm ²	2500mm ²	40°C/W
225mm ²	2500mm ²	2500mm ²	55°C/W
100mm ²	2500mm ²	2500mm ²	60°C/W
50mm ²	2500mm ²	2500mm ²	70°C/W

APPLICATIONS INFORMATION

Table 2. Measured Thermal Resistance for MS8 Package

COPPER AREA		BOARD AREA	THERMAL RESISTANCE (JUNCTION-TO-AMBIENT)
TOPSIDE*	BACKSIDE		
2500mm ²	2500mm ²	2500mm ²	110°C/W
1000mm ²	2500mm ²	2500mm ²	115°C/W
225mm ²	2500mm ²	2500mm ²	120°C/W
100mm ²	2500mm ²	2500mm ²	130°C/W
50mm ²	2500mm ²	2500mm ²	140°C/W

*Device is mounted on topside.

Calculating Junction Temperature

Example: Given an output voltage of 1.8V, an input voltage range of 2.25V to 2.75V, an output current range of 1mA to 100mA, and a maximum ambient temperature of 70°C, what will the maximum junction temperature be for an application using the DD package?

The power dissipated by the device is equal to:

$$I_{OUT(MAX)}(V_{IN(MAX)} - V_{OUT}) + I_{GND}(V_{IN(MAX)})$$

where

$$I_{OUT(MAX)} = 100\text{mA}$$

$$V_{IN(MAX)} = 2.75\text{V}$$

$$I_{GND} \text{ at } (I_{OUT} = 100\text{mA}, V_{IN} = 2.75\text{V}) = 3\text{mA}$$

so

$$P = 100\text{mA}(2.75\text{V} - 1.8\text{V}) + 3\text{mA}(2.75\text{V}) = 0.103\text{W}$$

The thermal resistance is in the range of 35°C/W to 70°C/W depending on the copper area. So the junction temperature rise above ambient is approximately equal to:

$$0.103\text{W}(52.5^\circ\text{C/W}) = 5.4^\circ\text{C}$$

The maximum junction temperature equals the maximum junction temperature rise above ambient plus the maximum ambient temperature or:

$$T_{JMAX} = 70^\circ\text{C} + 5.4^\circ\text{C} = 75.4^\circ\text{C}$$

Protection Features

The LT3020 incorporates several protection features that make it ideal for use in battery-powered circuits. In addition to the normal protection features associated with monolithic regulators, such as current limiting and thermal limiting, the device also protects against reverse-input voltages, reverse-output voltages and reverse output-to-input voltages.

Current limit protection and thermal overload protection protect the device against current overload conditions at the output of the device. For normal operation, do not exceed a junction temperature of 125°C.

The IN pins of the device withstand reverse voltages of 10V. The LT3020 limits current flow to less than 1μA and no negative voltage appears at OUT. The device protects both itself and the load against batteries that are plugged in backwards.

The LT3020 incurs no damage if OUT is pulled below ground. If IN is left open circuit or grounded, OUT can be pulled below ground by 10V. No current flows from the pass transistor connected to OUT. However, current flows in (but is limited by) the resistor divider that sets the output voltage. Current flows from the bottom resistor in the divider and from the ADJ pin's internal clamp through the top resistor in the divider to the external circuitry pulling OUT below ground. If IN is powered by a voltage source, OUT sources current equal to its current limit capability and the LT3020 protects itself by thermal limiting. In this case, grounding SHDN turns off the LT3020 and stops OUT from sourcing current.

The LT3020 incurs no damage if the ADJ pin is pulled above or below ground by 10V. If IN is left open circuit or grounded and ADJ is pulled above ground, ADJ acts like a 25k resistor in series with a 1V clamp (one Schottky diode in series with one diode). ADJ acts like a 25k resistor in series with a Schottky diode if pulled below ground. If IN is powered by a voltage source and ADJ is pulled below its reference voltage, the LT3020 attempts to source its current limit capability at OUT. The output voltage increases to $V_{IN} - V_{DROPOUT}$ with $V_{DROPOUT}$ set by whatever load current the LT3020 supports. This condition can potentially damage external circuitry powered by the LT3020 if the output voltage increases to an unregulated high voltage. If IN is powered by a voltage source and ADJ is pulled above its reference voltage, two situations can occur. If ADJ is pulled slightly above its reference voltage, the LT3020 turns off the pass transistor, no output current is sourced and the output voltage decreases to either the voltage at ADJ or less. If ADJ is pulled above its no load recovery threshold, the no load recovery circuitry turns on and attempts to sink current. OUT is actively pulled low

APPLICATIONS INFORMATION

and the output voltage clamps at a Schottky diode above ground. Please note that the behavior described above applies to the LT3020 only. If a resistor divider is connected under the same conditions, there will be additional V/R current.

In circuits where a backup battery is required, several different input/output conditions can occur. The output voltage may be held up while the input is either pulled to ground, pulled to some intermediate voltage or is left open circuit. In the case where the input is grounded, there is less than 1 μ A of reverse output current.

If the LT3020 IN pin is forced below the OUT pin or the OUT pin is pulled above the IN pin, input current drops to less than 10 μ A typically. This occurs if the LT3020 input is connected to a discharged (low voltage) battery and either a backup battery or a second regulator circuit holds up the output. The state of the SHDN pin has no effect on the reverse output current if OUT is pulled above IN.

Input Capacitance and Stability

The LT3020 is designed to be stable with a minimum capacitance of 2.2 μ F placed at the IN pin. Ceramic capacitors with very low ESR may be used. However, in cases where a long wire is used to connect a power supply to the input of the LT3020 (and also from the ground of the LT3020 back to the power supply ground), use of low value input capacitors combined with an output load current of 20mA or greater may result in an unstable application. This is due to the inductance of the wire forming an LC tank circuit with the input capacitor and not a result of the LT3020 being unstable.

The self-inductance, or isolated inductance, of a wire is directly proportional to its length. However, the diameter

of a wire does not have a major influence on its self-inductance. For example, the self inductance of a 2-AWG isolated wire with a diameter of 0.26 in. is about half the inductance of a 30-AWG wire with a diameter of 0.01 in. One foot of 30-AWG wire has 465nH of self inductance.

The overall self-inductance of a wire can be reduced in two ways. One is to divide the current flowing towards the LT3020 between two parallel conductors. In this case, the farther the wires are placed apart from each other, the more inductance will be reduced, up to a 50% reduction when placed a few inches apart. Splitting the wires basically connects two equal inductors in parallel. However, when placed in close proximity from each other, mutual inductance is added to the overall self inductance of the wires. The most effective way to reduce overall inductance is to place the forward and return-current conductors (the wire for the input and the wire for ground) in very close proximity. Two 30-AWG wires separated by 0.02 in. reduce the overall self-inductance to about one-fifth of a single isolated wire.

If the LT3020 is powered by a battery mounted in close proximity on the same circuit board, a 2.2 μ F input capacitor is sufficient for stability. However, if the LT3020 is powered by a distant supply, use a larger value input capacitor following the guideline of roughly 1 μ F (in addition to the 2.2 μ F minimum) per 8 inches of wire length. As power supply output impedance may vary, the minimum input capacitance needed to stabilize the application may also vary. Extra capacitance may also be placed directly on the output of the power supply; however, this will require an order of magnitude more capacitance as opposed to placing extra capacitance in close proximity to the LT3020. Furthermore, series resistance may be placed between the supply and the input of the LT3020 to stabilize the application; as little as 0.1 Ω to 0.5 Ω will suffice.

PACKAGE DESCRIPTION

DD Package
8-Lead Plastic DFN (3mm × 3mm)
 (Reference LTC DWG # 05-08-1698)

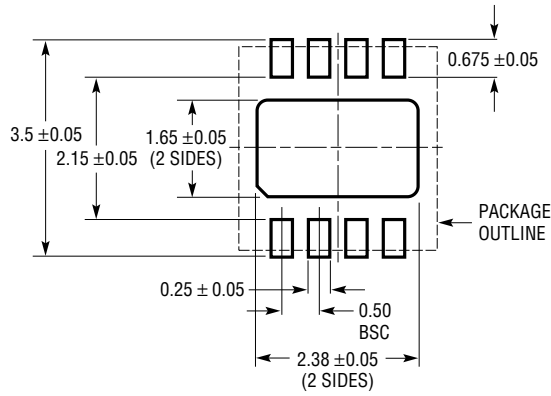

RECOMMENDED SOLDER PAD PITCH AND DIMENSIONS

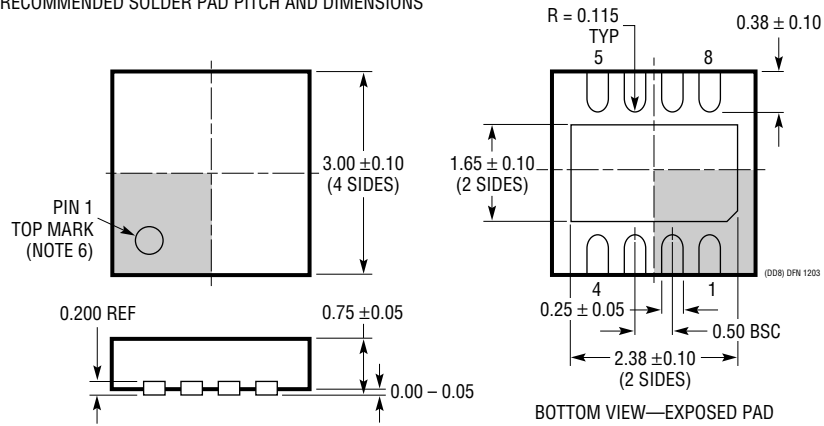

NOTE:

1. DRAWING TO BE MADE A JEDEC PACKAGE OUTLINE M0-229 VARIATION OF (WEED-1)
2. DRAWING NOT TO SCALE
3. ALL DIMENSIONS ARE IN MILLIMETERS
4. DIMENSIONS OF EXPOSED PAD ON BOTTOM OF PACKAGE DO NOT INCLUDE MOLD FLASH. MOLD FLASH, IF PRESENT, SHALL NOT EXCEED 0.15mm ON ANY SIDE
5. EXPOSED PAD SHALL BE SOLDER PLATED
6. SHADED AREA IS ONLY A REFERENCE FOR PIN 1 LOCATION ON TOP AND BOTTOM OF PACKAGE

PACKAGE DESCRIPTION

MS8 Package
8-Lead Plastic MSOP
(Reference LTC DWG # 05-08-1660)

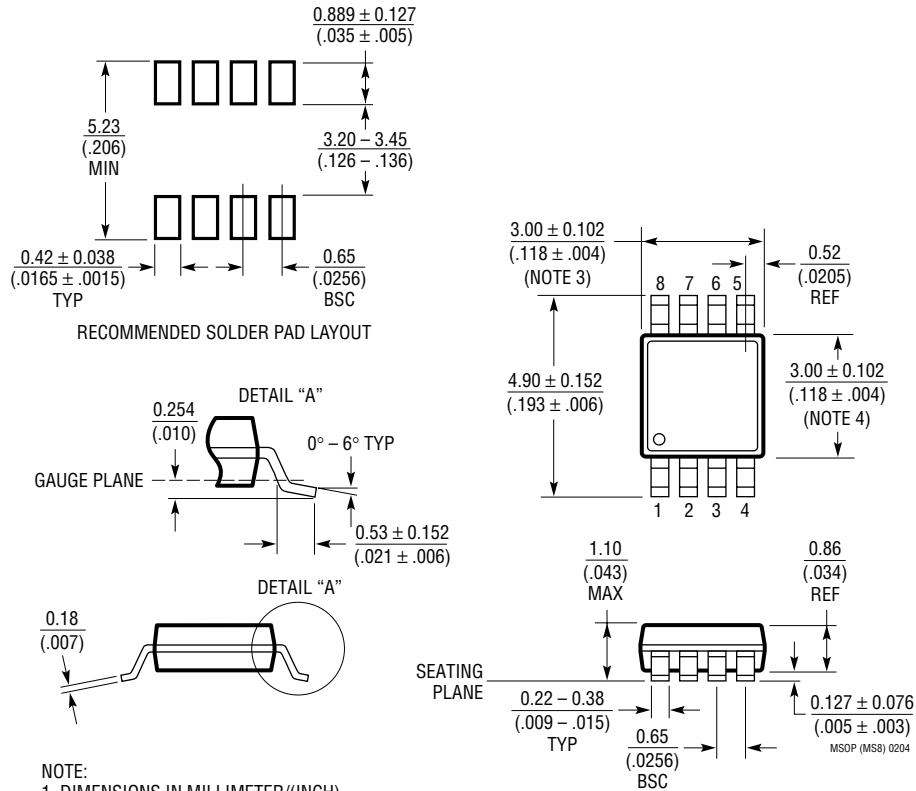

- NOTE:
1. DIMENSIONS IN MILLIMETER/(INCH)
 2. DRAWING NOT TO SCALE
 3. DIMENSION DOES NOT INCLUDE MOLD FLASH, PROTRUSIONS OR GATE BURRS.
MOLD FLASH, PROTRUSIONS OR GATE BURRS SHALL NOT EXCEED 0.152mm (.006") PER SIDE
 4. DIMENSION DOES NOT INCLUDE INTERLEAD FLASH OR PROTRUSIONS.
INTERLEAD FLASH OR PROTRUSIONS SHALL NOT EXCEED 0.152mm (.006") PER SIDE
 5. LEAD COPLANARITY (BOTTOM OF LEADS AFTER FORMING) SHALL BE 0.102mm (.004") MAX

LT3020/LT3020-1.2/ LT3020-1.5/LT3020-1.8

RELATED PARTS

PART NUMBER	DESCRIPTION	COMMENTS
LT1121/LT1121HV	150mA, Micropower LDOs	V_{IN} : 4.2V to 30V/36V, $V_{OUT(MIN)}$ = 3.75V, V_{DO} = 0.42V, I_Q = 30 μ A, I_{SD} = 16 μ A, Reverse-Battery Protection, SOT-223, S8, Z Packages
LT1129	700mA, Micropower LDO	V_{IN} : 4.2V to 30V, $V_{OUT(MIN)}$ = 3.75V, V_{DO} = 0.4V, I_Q = 50 μ A, I_{SD} = 16 μ A, DD, SOT-223, S8, TO220-5, TSSOP20 Packages
LT1761	100mA, Low Noise Micropower LDO	V_{IN} : 1.8V to 20V, $V_{OUT(MIN)}$ = 1.22V, V_{DO} = 0.3V, I_Q = 20 μ A, I_{SD} < 1 μ A, Low Noise: < 20 μ V _{RMS} , Stable with 1 μ F Ceramic Capacitor, ThinSOT Package
LT1762	150mA, Low Noise Micropower LDO	V_{IN} : 1.8V to 20V, $V_{OUT(MIN)}$ = 1.22V, V_{DO} = 0.3V, I_Q = 25 μ A, I_{SD} < 1 μ A, Low Noise: < 20 μ V _{RMS} , MS8 Package
LT1763	500mA, Low Noise Micropower LDO	V_{IN} : 1.8V to 20V, $V_{OUT(MIN)}$ = 1.22V, V_{DO} = 0.3V, I_Q = 30 μ A, I_{SD} < 1 μ A, Low Noise: < 20 μ V _{RMS} , S8 Package
LT1764/LT1764A	3A, Low Noise, Fast Transient Response LDOs	V_{IN} : 2.7V to 20V, $V_{OUT(MIN)}$ = 1.21V, V_{DO} = 0.34V, I_Q = 1mA, I_{SD} < 1 μ A, Low Noise: < 40 μ V _{RMS} , "A" Version Stable with Ceramic Capacitors, DD, TO220-5 Packages
LTC1844	150mA, Low Noise, Micropower VLDO	V_{IN} : 1.6V to 6.5V, $V_{OUT(MIN)}$ = 1.25V, V_{DO} = 0.09V, I_Q = 35 μ A, I_{SD} < 1 μ A, Low Noise: < 30 μ V _{RMS} , ThinSOT Package
LT1962	300mA, Low Noise Micropower LDO	V_{IN} : 1.8V to 20V, $V_{OUT(MIN)}$ = 1.22V, V_{DO} = 0.27V, I_Q = 30 μ A, I_{SD} < 1 μ A, Low Noise: < 20 μ V _{RMS} , MS8 Package
LT1963/LT1963A	1.5A, Low Noise, Fast Transient Response LDOs	V_{IN} : 2.1V to 20V, $V_{OUT(MIN)}$ = 1.21V, V_{DO} = 0.34V, I_Q = 1mA, I_{SD} < 1 μ A, Low Noise: < 40 μ V _{RMS} , "A" Version Stable with Ceramic Capacitors, DD, TO220-5, SOT223, S8 Packages
LT1964	200mA, Low Noise Micropower, Negative LDO	V_{IN} : -2.2V to -20V, $V_{OUT(MIN)}$ = 1.21V, V_{DO} = 0.34V, I_Q = 30 μ A, I_{SD} = 3 μ A, Low Noise: < 30 μ V _{RMS} , Stable with Ceramic Capacitors, ThinSOT Package
LT3010	50mA, High Voltage, Micropower LDO	V_{IN} : 3V to 80V, $V_{OUT(MIN)}$ = 1.2V, V_{DO} = 0.3V, I_Q = 30 μ A, I_{SD} < 1 μ A, Low Noise: < 100 μ V _{RMS} , Stable with 1 μ F Output Capacitor, Exposed MS8E Package
LTC3025	300mA, Low Voltage, Micropower LDO	V_{IN} : 0.9V to 5.5V, $V_{OUT(MIN)}$ = 0.4V, V_{DO} = 0.05V, I_Q = 54 μ A, Stable with 1 μ F Ceramic Capacitors, DFN-6 Package
LT3150	Low V_{IN} , Fast Transient Response, VLDO Controller	V_{IN} : 1.1V to 10V, $V_{OUT(MIN)}$ = 1.23V, V_{DO} = Set by External MOSFET $R_{DS(ON)}$, 1.4MHz Boost Converter Generates Gate Drive, SSOP16 Package