

TABLE OF CONTENTS

Features	1	Pin Configuration and Function Descriptions.....	8
Applications.....	1	Typical Performance Characteristics	9
Functional Block Diagram	1	Applications Information	14
General Description	1	Application Schematics	14
Revision History	2	Transformer Design	15
Specifications.....	3	Transformer Turns Ratio.....	15
Electrical Characteristics—5 V Primary Input Supply/ 5 V Secondary Isolated Supply	3	Transformer ET Constant	15
Electrical Characteristics—3.3 V Primary Input Supply/ 3.3 V Secondary Isolated Supply	3	Transformer Primary Inductance and Resistance	16
Electrical Characteristics—5 V Primary Input Supply/ 3.3 V Secondary Isolated Supply	4	Transformer Isolation Voltage	16
Electrical Characteristics—5 V Primary Input Supply/ 15 V Secondary Isolated Supply	4	Switching Frequency.....	16
Package Characteristics	5	Transient Response	16
Regulatory Approvals (Pending).....	5	Component Selection	16
Insulation and Safety-Related Specifications.....	5	Printed Circuit Board (PCB) Layout	17
DIN V VDE V 0884-10 (VDE V 0884-10):2006-12 Insulation Characteristics.....	6	Thermal Analysis	17
Recommended Operating Conditions	6	Power Consumption	17
Absolute Maximum Ratings.....	7	Power Considerations.....	17
ESD Caution.....	7	Insulation Lifetime	18
		Outline Dimensions	19
		Ordering Guide	19

REVISION HISTORY

10/12—Revision 0: Initial Version

SPECIFICATIONS

ELECTRICAL CHARACTERISTICS—5 V PRIMARY INPUT SUPPLY/5 V SECONDARY ISOLATED SUPPLY

$4.5\text{ V} \leq V_{DD1} = V_{DDA} \leq 5.5\text{ V}$, $V_{DD2} = V_{REG} = V_{ISO} = 5.0\text{ V}$, $f_{SW} = 500\text{ kHz}$, all voltages are relative to their respective grounds (see the application schematic in Figure 31). All minimum/maximum specifications apply over the entire recommended operating range, unless otherwise noted. All typical specifications are at $T_A = 25^\circ\text{C}$, $V_{DD1} = V_{DDA} = 5.0\text{ V}$, $V_{DD2} = V_{REG} = V_{ISO} = 5.0\text{ V}$.

Table 1. DC-to-DC Converter Static Specifications

Parameter	Symbol	Min	Typ	Max	Unit	Test Conditions/Comments
DC-TO-DC CONVERTER SUPPLY						
Isolated Output Voltage	V_{ISO}	4.5	5.0	5.5	V	$I_{ISO} = 0\text{ mA}$, $V_{ISO} = V_{FB} \times (R1 + R2)/R2$
Feedback Voltage Setpoint	V_{FB}	1.15	1.25	1.37	V	$I_{ISO} = 0\text{ mA}$
Line Regulation ¹	$V_{ISO(LINE)}$		1	10	mV/V	$I_{ISO} = 50\text{ mA}$, $V_{DD1} = V_{DDA} = 4.5\text{ V to }5.5\text{ V}$
Load Regulation	$V_{ISO(LOAD)}$		1	2	%	$I_{ISO} = 50\text{ mA to }200\text{ mA}$
Output Ripple	$V_{ISO(RIP)}$		50		mV p-p	20 MHz bandwidth, $C_{OUT} = 0.1\text{ }\mu\text{F} 47\text{ }\mu\text{F}$, $I_{ISO} = 100\text{ mA}$
Output Noise	$V_{ISO(NOISE)}$		100		mV p-p	20 MHz bandwidth, $C_{OUT} = 0.1\text{ }\mu\text{F} 47\text{ }\mu\text{F}$, $I_{ISO} = 100\text{ mA}$
Switching Frequency	f_{SW}		1000		kHz	$R_{OC} = 50\text{ k}\Omega$
			200		kHz	$R_{OC} = 270\text{ k}\Omega$
		192	318	515	kHz	$V_{OC} = V_{DD2}$ (open loop)
I_{DDA} Quiescent Current	$I_{DDA(Q)}$		4	5	mA	
Switch On Resistance	R_{ON}		0.5		Ω	
Maximum Output Supply Current	$I_{ISO(MAX)}$	400	500		mA	$f_{SW} \leq 1\text{ MHz}$, $V_{ISO} = 5.0\text{ V}$
Efficiency at Maximum Output Current			72		%	$I_{ISO} = I_{ISO(MAX)}$, $f_{SW} \leq 1\text{ MHz}$

¹ V_{DD1} is the power supply for the push-pull transformer; V_{DDA} is the power supply for Side 1 of the ADuM4070.

ELECTRICAL CHARACTERISTICS—3.3 V PRIMARY INPUT SUPPLY/3.3 V SECONDARY ISOLATED SUPPLY

$3.0\text{ V} \leq V_{DD1} = V_{DDA} \leq 3.6\text{ V}$, $V_{DD2} = V_{REG} = V_{ISO} = 3.3\text{ V}$, $f_{SW} = 500\text{ kHz}$, all voltages are relative to their respective grounds (see the application schematic in Figure 31). All minimum/maximum specifications apply over the entire recommended operating range, unless otherwise noted. All typical specifications are at $T_A = 25^\circ\text{C}$, $V_{DD1} = V_{DDA} = 3.3\text{ V}$, $V_{DD2} = V_{REG} = V_{ISO} = 3.3\text{ V}$.

Table 2. DC-to-DC Converter Static Specifications

Parameter	Symbol	Min	Typ	Max	Unit	Test Conditions/Comments
DC-TO-DC CONVERTER SUPPLY						
Isolated Output Voltage	V_{ISO}	3.0	3.3	3.63	V	$I_{ISO} = 0\text{ mA}$, $V_{ISO} = V_{FB} \times (R1 + R2)/R2$
Feedback Voltage Setpoint	V_{FB}	1.15	1.25	1.37	V	$I_{ISO} = 0\text{ mA}$
Line Regulation ¹	$V_{ISO(LINE)}$		1	10	mV/V	$I_{ISO} = 50\text{ mA}$, $V_{DD1} = V_{DDA} = 3.0\text{ V to }3.6\text{ V}$
Load Regulation	$V_{ISO(LOAD)}$		1	2	%	$I_{ISO} = 50\text{ mA to }200\text{ mA}$
Output Ripple	$V_{ISO(RIP)}$		50		mV p-p	20 MHz bandwidth, $C_{OUT} = 0.1\text{ }\mu\text{F} 47\text{ }\mu\text{F}$, $I_{ISO} = 100\text{ mA}$
Output Noise	$V_{ISO(NOISE)}$		100		mV p-p	20 MHz bandwidth, $C_{OUT} = 0.1\text{ }\mu\text{F} 47\text{ }\mu\text{F}$, $I_{ISO} = 100\text{ mA}$
Switching Frequency	f_{SW}		1000		kHz	$R_{OC} = 50\text{ k}\Omega$
			200		kHz	$R_{OC} = 270\text{ k}\Omega$
		192	318	515	kHz	$V_{OC} = V_{DD2}$ (open loop)
I_{DDA} Quiescent Current	$I_{DDA(Q)}$		2	3.5	mA	
Switch On Resistance	R_{ON}		0.6		Ω	
Maximum Output Supply Current	$I_{ISO(MAX)}$	250	350		mA	$f_{SW} \leq 1\text{ MHz}$, $V_{ISO} = 3.3\text{ V}$
Efficiency at Maximum Output Current			68		%	$I_{ISO} = I_{ISO(MAX)}$, $f_{SW} \leq 1\text{ MHz}$

¹ V_{DD1} is the power supply for the push-pull transformer; V_{DDA} is the power supply for Side 1 of the ADuM4070.

ELECTRICAL CHARACTERISTICS—5 V PRIMARY INPUT SUPPLY/3.3 V SECONDARY ISOLATED SUPPLY

$4.5\text{ V} \leq V_{DD1} = V_{DDA} \leq 5.5\text{ V}$, $V_{DD2} = V_{REG} = V_{ISO} = 3.3\text{ V}$, $f_{SW} = 500\text{ kHz}$, all voltages are relative to their respective grounds (see the application schematic in Figure 31). All minimum/maximum specifications apply over the entire recommended operating range, unless otherwise noted. All typical specifications are at $T_A = 25^\circ\text{C}$, $V_{DD1} = V_{DDA} = 5.0\text{ V}$, $V_{DD2} = V_{REG} = V_{ISO} = 3.3\text{ V}$.

Table 3. DC-to-DC Converter Static Specifications

Parameter	Symbol	Min	Typ	Max	Unit	Test Conditions/Comments
DC-TO-DC CONVERTER SUPPLY						
Isolated Output Voltage	V_{ISO}	3.0	3.3	3.63	V	$I_{ISO} = 0\text{ mA}$, $V_{ISO} = V_{FB} \times (R1 + R2)/R2$
Feedback Voltage Setpoint	V_{FB}	1.15	1.25	1.37	V	$I_{ISO} = 0\text{ mA}$
Line Regulation ¹	$V_{ISO(LINE)}$		1	10	mV/V	$I_{ISO} = 50\text{ mA}$, $V_{DD1} = V_{DDA} = 4.5\text{ V to }5.5\text{ V}$
Load Regulation	$V_{ISO(LOAD)}$		1	2	%	$I_{ISO} = 50\text{ mA to }200\text{ mA}$
Output Ripple	$V_{ISO(RIP)}$		50		mV p-p	20 MHz bandwidth, $C_{OUT} = 0.1\text{ }\mu\text{F}$ 47 μF , $I_{ISO} = 100\text{ mA}$
Output Noise	$V_{ISO(NOISE)}$		100		mV p-p	20 MHz bandwidth, $C_{OUT} = 0.1\text{ }\mu\text{F}$ 47 μF , $I_{ISO} = 100\text{ mA}$
Switching Frequency	f_{SW}		1000		kHz	$R_{OC} = 50\text{ k}\Omega$
			200		kHz	$R_{OC} = 270\text{ k}\Omega$
		209	318	515	kHz	$V_{OC} = V_{DD2}$ (open loop)
I_{DDA} Quiescent Current	$I_{DDA(Q)}$		3.5	5	mA	
Switch On Resistance	R_{ON}		0.5		Ω	
Maximum Output Supply Current	$I_{ISO(MAX)}$	400	500		mA	$f_{SW} \leq 1\text{ MHz}$, $V_{ISO} = 3.3\text{ V}$
Efficiency at Maximum Output Current			70		%	$I_{ISO} = I_{ISO(MAX)}$, $f_{SW} \leq 1\text{ MHz}$

¹ V_{DD1} is the power supply for the push-pull transformer; V_{DDA} is the power supply for Side 1 of the ADuM4070.

ELECTRICAL CHARACTERISTICS—5 V PRIMARY INPUT SUPPLY/15 V SECONDARY ISOLATED SUPPLY

$4.5\text{ V} \leq V_{DD1} = V_{DDA} \leq 5.5\text{ V}$, $V_{REG} = V_{ISO} = 15\text{ V}$, $V_{DD2} = 5.0\text{ V}$, $f_{SW} = 500\text{ kHz}$, all voltages are relative to their respective grounds (see the application schematic in Figure 32). All minimum/maximum specifications apply over the entire recommended operating range, unless otherwise noted. All typical specifications are at $T_A = 25^\circ\text{C}$, $V_{DD1} = V_{DDA} = 5.0\text{ V}$, $V_{REG} = V_{ISO} = 15\text{ V}$, $V_{DD2} = 5.0\text{ V}$.

Table 4. DC-to-DC Converter Static Specifications

Parameter	Symbol	Min	Typ	Max	Unit	Test Conditions/Comments
DC-TO-DC CONVERTER SUPPLY						
Isolated Output Voltage	V_{ISO}	13.8	15.0	16.5	V	$I_{ISO} = 0\text{ mA}$, $V_{ISO} = V_{FB} \times (R1 + R2)/R2$
Feedback Voltage Setpoint	V_{FB}	1.15	1.25	1.37	V	$I_{ISO} = 0\text{ mA}$
V_{DD2} Linear Regulator Voltage	V_{DD2}	4.5	5.0	5.5	V	$V_{REG} = 7\text{ V to }15\text{ V}$, $I_{DD2} = 0\text{ mA to }50\text{ mA}$
Dropout Voltage	$V_{DD2(DO)}$		0.5	1.5	V	$I_{DD2} = 50\text{ mA}$
Line Regulation ¹	$V_{ISO(LINE)}$		1	20	mV/V	$I_{ISO} = 50\text{ mA}$, $V_{DD1} = V_{DDA} = 4.5\text{ V to }5.5\text{ V}$
Load Regulation	$V_{ISO(LOAD)}$		1	3	%	$I_{ISO} = 20\text{ mA to }80\text{ mA}$
Output Ripple	$V_{ISO(RIP)}$		200		mV p-p	20 MHz bandwidth, $C_{OUT} = 0.1\text{ }\mu\text{F}$ 47 μF , $I_{ISO} = 100\text{ mA}$
Output Noise	$V_{ISO(NOISE)}$		500		mV p-p	20 MHz bandwidth, $C_{OUT} = 0.1\text{ }\mu\text{F}$ 47 μF , $I_{ISO} = 100\text{ mA}$
Switching Frequency	f_{SW}		1000		kHz	$R_{OC} = 50\text{ k}\Omega$
			200		kHz	$R_{OC} = 270\text{ k}\Omega$
		192	318	515	kHz	$V_{OC} = V_{DD2}$ (open loop)
I_{DDA} Quiescent Current	$I_{DDA(Q)}$		3.5	5	mA	
Switch On Resistance	R_{ON}		0.5		Ω	
Maximum Output Supply Current	$I_{ISO(MAX)}$	100	140		mA	$f_{SW} \leq 1\text{ MHz}$, $V_{ISO} = 15.0\text{ V}$
Efficiency at Maximum Output Current			78		%	$I_{ISO} = I_{ISO(MAX)}$, $f_{SW} \leq 1\text{ MHz}$

¹ V_{DD1} is the power supply for the push-pull transformer; V_{DDA} is the power supply for Side 1 of the ADuM4070.

PACKAGE CHARACTERISTICS

Table 5.

Parameter	Symbol	Min	Typ	Max	Unit	Test Conditions/Comments
RESISTANCE AND CAPACITANCE						
Resistance (Input to Output) ¹	R _{I-O}		10 ¹²		Ω	f = 1 MHz Thermocouple is located at the center of the package underside; test conducted on a 4-layer board with thin traces ²
Capacitance (Input to Output) ¹	C _{I-O}		2.2		pF	
IC Junction to Ambient Thermal Resistance	θ _{JA}		45		°C/W	
THERMAL SHUTDOWN						
Thermal Shutdown Threshold	TS _{SD}		150		°C	T _j rising
Thermal Shutdown Hysteresis	TS _{SD-HYS}		20		°C	

¹ The device is considered a 2-terminal device: Pin 1 to Pin 8 are shorted together, and Pin 9 to Pin 16 are shorted together.

² See the Thermal Analysis section for thermal model definitions.

REGULATORY APPROVALS (PENDING)

The ADuM4070 is pending approval by the organizations listed in Table 6. For more information about the recommended maximum working voltages for specific cross-insulation waveforms and insulation levels, see Table 11 and the Insulation Lifetime section.

Table 6.

UL ¹	CSA	VDE ²
Recognized under UL 1577 component recognition program	Approved under CSA Component Acceptance Notice #5A	Certified according to DIN V VDE V 0884-10 (VDE V 0884-10):2006-12
Single protection, 5000 V rms isolation voltage	Basic insulation per CSA 60950-1-03 and IEC 60950-1, 600 V rms (848 V peak) maximum working voltage Reinforced insulation per CSA 60950-1-03 and IEC 60950-1, 400 V rms (565 V peak) maximum working voltage Reinforced insulation per IEC 60601-1, 250 V rms (353 V peak) maximum working voltage	Reinforced insulation, 849 V peak
File E214100	File 205078	File 2471900-4880-0001

¹ In accordance with UL 1577, each ADuM4070 is proof tested by applying an insulation test voltage ≥ 6000 V rms for 1 sec (current leakage detection limit = 10 μA).

² In accordance with DIN V VDE V 0884-10 (VDE V 0884-10):2006-12, each ADuM4070 is proof tested by applying an insulation test voltage ≥ 1050 V peak for 1 sec (partial discharge detection limit = 5 pC). The asterisk (*) marking branded on the component designates DIN V VDE V 0884-10 (VDE V 0884-10):2006-12 approval.

INSULATION AND SAFETY-RELATED SPECIFICATIONS

Table 7.

Parameter	Symbol	Value	Unit	Test Conditions/Comments
Rated Dielectric Insulation Voltage		5000	V rms	1-minute duration
Minimum External Air Gap (Clearance)	L(I01)	>8.0	mm	Measured from input terminals to output terminals, shortest distance through air
Minimum External Tracking (Creepage)	L(I02)	>8.3	mm	Measured from input terminals to output terminals, shortest distance path along body
Minimum Internal Distance (Internal Clearance)		0.017 min	mm	Distance through insulation
Tracking Resistance (Comparative Tracking Index)	CTI	>400	V	DIN IEC 112/VDE 0303, Part 1
Isolation Group		II		Material Group (DIN VDE 0110, 1/89, Table 1)

DIN V VDE V 0884-10 (VDE V 0884-10):2006-12 INSULATION CHARACTERISTICS

This isolator is suitable for reinforced electrical isolation only within the safety limit data. Protective circuits ensure maintenance of the safety data. The asterisk (*) marking branded on the component denotes DIN V VDE V 0884-10 (VDE V 0884-10):2006-12 approval.

Table 8.

Description	Test Conditions/Comments	Symbol	Characteristic	Unit
Installation Classification per DIN VDE 0110 For Rated Mains Voltage ≤ 150 V rms For Rated Mains Voltage ≤ 300 V rms For Rated Mains Voltage ≤ 400 V rms			I to IV I to IV I to III	
Climatic Classification			40/105/21	
Pollution Degree per DIN VDE 0110, Table 1			2	
Maximum Working Insulation Voltage		V_{IORM}	849	V peak
Input-to-Output Test Voltage, Method B1	$V_{IORM} \times 1.875 = V_{pd(m)}$, 100% production test, $t_{ini} = t_m = 1$ sec, partial discharge < 5 pC	$V_{pd(m)}$	1592	V peak
Input-to-Output Test Voltage, Method A After Environmental Tests Subgroup 1	$V_{IORM} \times 1.5 = V_{pd(m)}$, $t_{ini} = 60$ sec, $t_m = 10$ sec, partial discharge < 5 pC	$V_{pd(m)}$	1273	V peak
After Input and/or Safety Tests Subgroup 2 and Subgroup 3	$V_{IORM} \times 1.2 = V_{pd(m)}$, $t_{ini} = 60$ sec, $t_m = 10$ sec, partial discharge < 5 pC	$V_{pd(m)}$	1018	V peak
Highest Allowable Overvoltage		V_{IOTM}	6000	V peak
Surge Isolation Voltage		V_{IOSM}	6000	V peak
Safety Limiting Values	V peak = 10 kV, 1.2 μs rise time, 50 μs, 50% fall time Maximum value allowed in the event of a failure (see Figure 2)			
Case Temperature		T_s	150	°C
Power Dissipation, Side 1, Side 2		P_{VDDAV} , P_{VREG}	2.78	W
Insulation Resistance at T_s	$V_{IO} = 500$ V	R_s	>10 ⁹	Ω

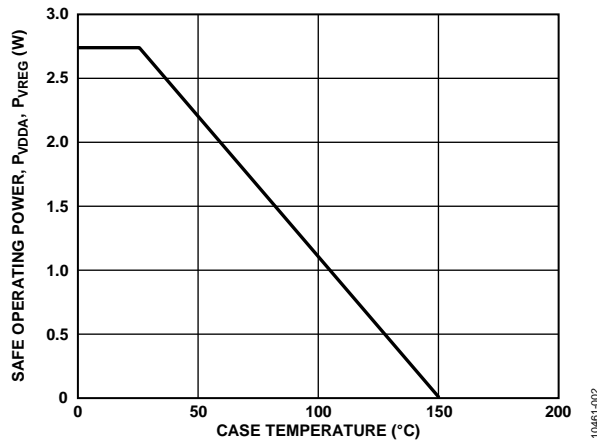

Figure 2. Thermal Derating Curve, Dependence of Safety Limiting Values on Case Temperature, per DIN EN 60747-5-2

RECOMMENDED OPERATING CONDITIONS

Table 9.

Parameter	Symbol	Min	Max	Unit
TEMPERATURE				
Operating Temperature	T_A	-40	+105	°C
LOAD				
Minimum Load	$I_{ISO(MIN)}$	10		mA

ABSOLUTE MAXIMUM RATINGS

Ambient temperature = 25°C, unless otherwise noted.

Table 10.

Parameter	Rating
Storage Temperature Range (T_{ST})	-55°C to +150°C
Ambient Operating Temperature Range (T_A)	-40°C to +105°C
Supply Voltages ¹	
V_{DDA} , V_{DD2} ²	-0.5 V to +7.0 V
V_{REG} , X1, X2	-0.5 V to +20.0 V
Common-Mode Transients ³	-100 kV/μs to +100 kV/μs

¹ Each voltage is relative to its respective ground.

² V_{DD1} is the power supply for the push-pull transformer; V_{DDA} is the power supply for Side 1 of the ADuM4070.

³ Refers to common-mode transients across the insulation barrier. Common-mode transients exceeding the absolute maximum ratings may cause latch-up or permanent damage.

Stresses above those listed under Absolute Maximum Ratings may cause permanent damage to the device. This is a stress rating only; functional operation of the device at these or any other conditions above those indicated in the operational section of this specification is not implied. Exposure to absolute maximum rating conditions for extended periods may affect device reliability.

ESD CAUTION



ESD (electrostatic discharge) sensitive device. Charged devices and circuit boards can discharge without detection. Although this product features patented or proprietary protection circuitry, damage may occur on devices subjected to high energy ESD. Therefore, proper ESD precautions should be taken to avoid performance degradation or loss of functionality.

Table 11. Maximum Continuous Working Voltage Supporting a 50-Year Minimum Lifetime¹

Parameter	Max	Unit	Constraint
AC Voltage, Bipolar Waveform	565	V peak	50-year minimum lifetime
AC Voltage, Unipolar Waveform	848	V peak	50-year minimum lifetime
DC Voltage	848	V peak	50-year minimum lifetime

¹ Refers to the continuous voltage magnitude imposed across the isolation barrier. See the Insulation Lifetime section for more information.

PIN CONFIGURATION AND FUNCTION DESCRIPTIONS

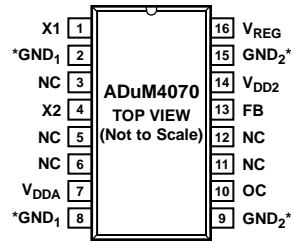

NOTES

1. NC = NO CONNECT. DO NOT CONNECT TO THIS PIN.

*PIN 2 AND PIN 8 ARE INTERNALLY CONNECTED; IT IS RECOMMENDED THAT BOTH PINS BE CONNECTED TO A COMMON GROUND. PIN 9 AND PIN 15 ARE INTERNALLY CONNECTED; IT IS RECOMMENDED THAT BOTH PINS BE CONNECTED TO A COMMON GROUND.

10461-003

Figure 3. Pin Configuration

Table 12. Pin Function Descriptions

Pin No.	Mnemonic	Description
1	X1	Transformer Driver Output 1.
2, 8	GND ₁	Ground Reference for the Primary Side of the Isolator. Pin 2 and Pin 8 are internally connected to each other; it is recommended that both pins be connected to a common ground.
3, 5, 6, 11, 12	NC	No Connect. Do not connect to this pin.
4	X2	Transformer Driver Output 2.
7	V _{DDA}	Supply Voltage for the Primary Side, 3.0 V to 5.5 V. Connect a 0.1 μF bypass capacitor from V _{DDA} to GND ₁ .
9, 15	GND ₂	Ground Reference for the Secondary Side of the Isolator. Pin 9 and Pin 15 are internally connected to each other; it is recommended that both pins be connected to a common ground.
10	OC	Oscillator Control Pin. When the OC pin is connected high to the V _{DD2} pin, the secondary controller runs in open-loop (unregulated) mode. To regulate the output voltage, connect a resistor between the OC pin and GND ₂ ; the secondary controller runs at a frequency of 200 kHz to 1 MHz, as programmed by the resistor value.
13	FB	Feedback Input from the Secondary Output Voltage, V _{ISO} . Use a resistor divider from the V _{ISO} output to the FB pin to set the V _{FB} voltage equal to the 1.25 V internal reference level using the formula $V_{ISO} = V_{FB} \times (R1 + R2)/R2$. The resistor divider is required even in open-loop mode to provide soft start.
14	V _{DD2}	Internal Supply Voltage for the Secondary Side. When a sufficient external voltage is supplied to V _{REG} , the internal regulator regulates the V _{DD2} pin to 5.0 V. Otherwise, V _{DD2} should be in the 3.0 V to 5.5 V range. Connect a 0.1 μF bypass capacitor from V _{DD2} to GND ₂ .
16	V _{REG}	Input of the Internal Regulator to Power the Secondary Side Controller. V _{REG} should be in the 5.5 V to 15 V range to regulate the V _{DD2} output to 5.0 V.

TYPICAL PERFORMANCE CHARACTERISTICS

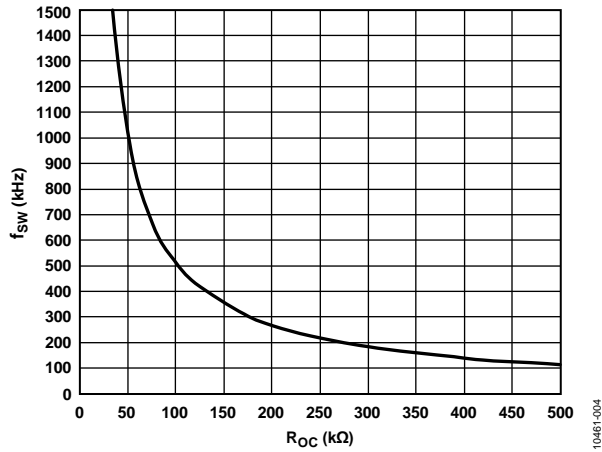

Figure 4. Switching Frequency (f_{SW}) vs. R_{OC} Resistance

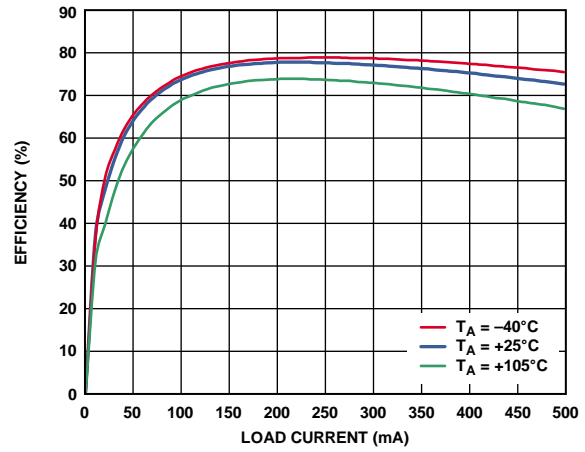

Figure 7. Typical Efficiency over Temperature with 1:2 Coilcraft Transformer (CR7983-CL), $f_{SW} = 500$ kHz, 5 V Input to 5 V Output

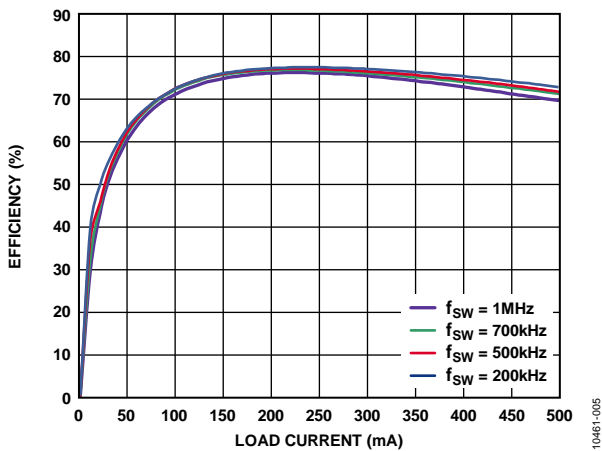

Figure 5. Typical Efficiency at Various Switching Frequencies with 1:2 Coilcraft Transformer (CR7983-CL), 5 V Input to 5 V Output

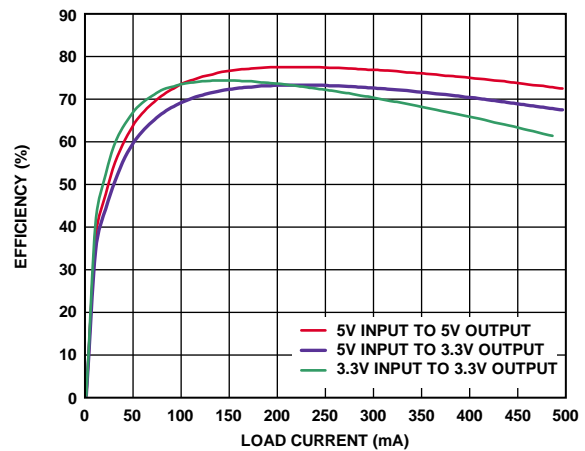

Figure 8. Single-Supply Efficiency with 1:2 Coilcraft Transformer (CR7983-CL), $f_{SW} = 500$ kHz

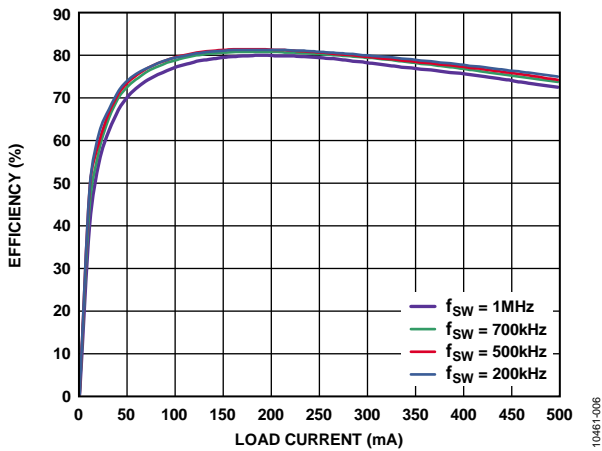

Figure 6. Typical Efficiency at Various Switching Frequencies with 1:2 Halo Transformer (TGSAD-560V8LF), 5 V Input to 5 V Output

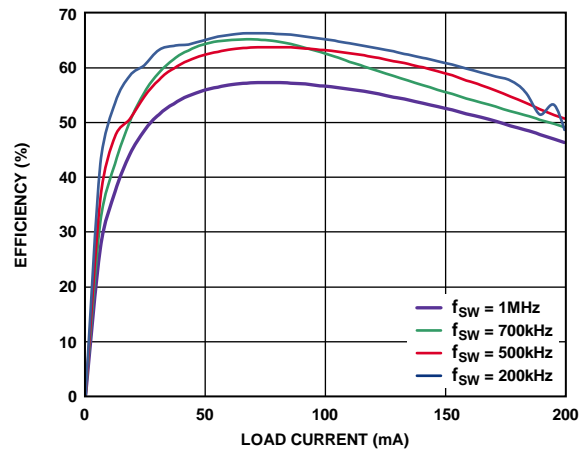

Figure 9. Typical Efficiency at Various Switching Frequencies with 1:3 Coilcraft Transformer (CR7984-CL), 3.3 V Input to 5 V Output

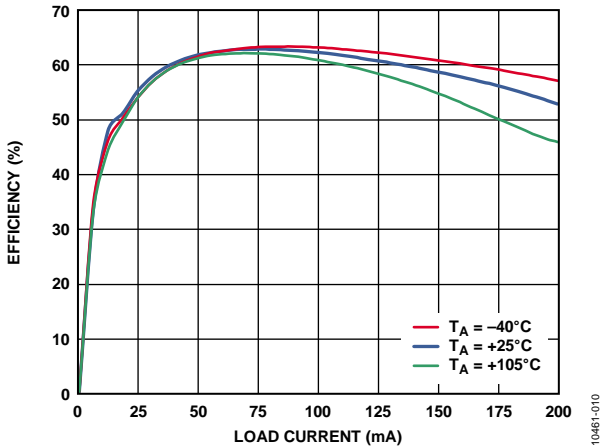

Figure 10. Typical Efficiency over Temperature with 1:3 Coilcraft Transformer (CR7984-CL), $f_{SW} = 500 \text{ kHz}$, 3.3 V Input to 5 V Output

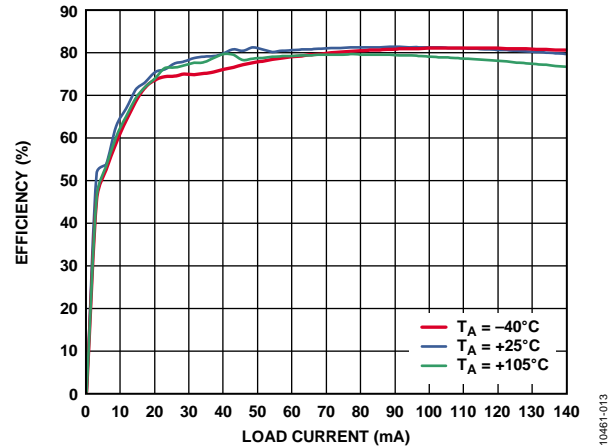

Figure 13. Typical Efficiency over Temperature with 1:3 Coilcraft Transformer (CR7984-CL), $f_{SW} = 500 \text{ kHz}$, 5 V Input to 15 V Output

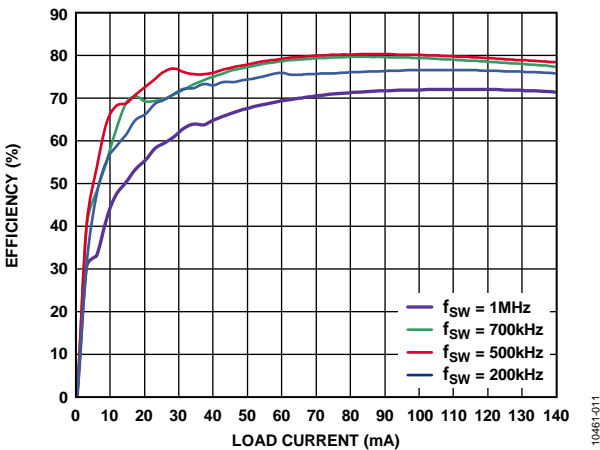

Figure 11. Typical Efficiency at Various Switching Frequencies with 1:3 Coilcraft Transformer (CR7984-CL), 5 V Input to 15 V Output

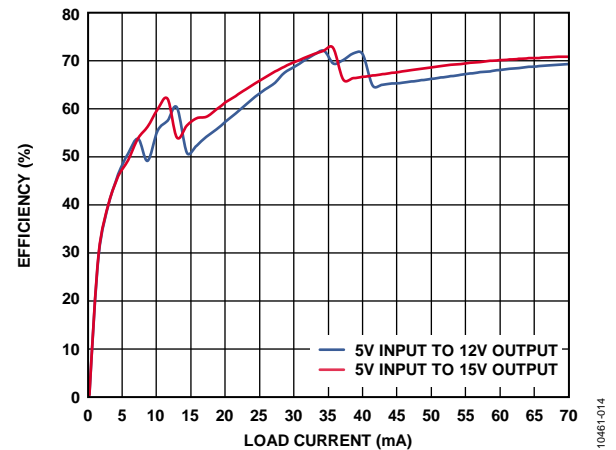

Figure 14. Double-Supply Efficiency with 1:5 Coilcraft Transformer (CR7985-CL), $f_{SW} = 500 \text{ kHz}$

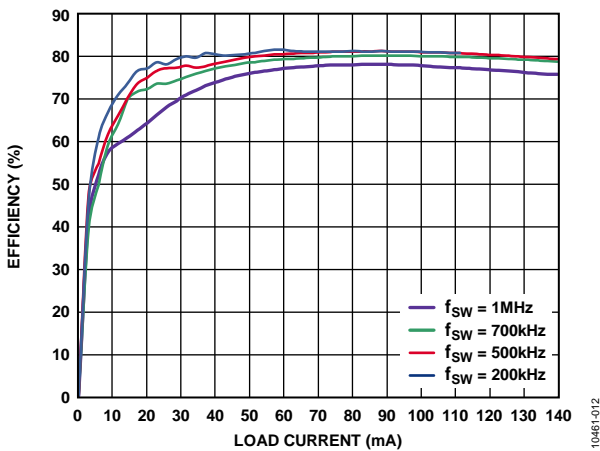

Figure 12. Typical Efficiency at Various Switching Frequencies with 1:3 Halo Transformer (TGSAD-590V8LF), 5 V Input to 15 V Output

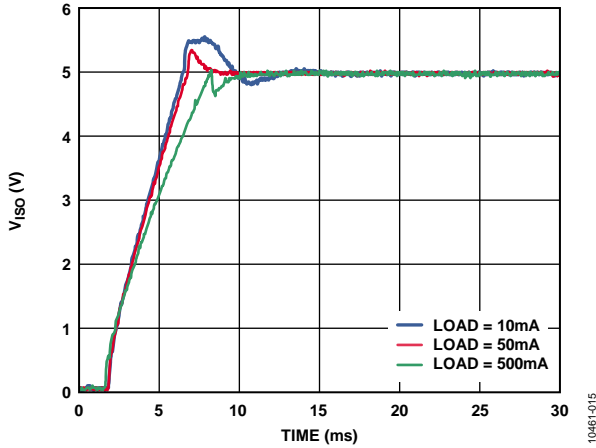

Figure 15. Typical V_{ISO} Startup with 10 mA, 50 mA, and 500 mA Output Load, 5 V Input to 5 V Output

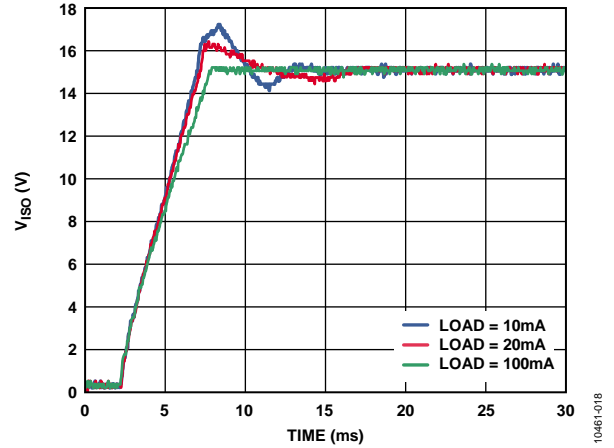

Figure 18. Typical V_{ISO} Startup with 10 mA, 20 mA, and 100 mA Output Load, 5 V Input to 15 V Output

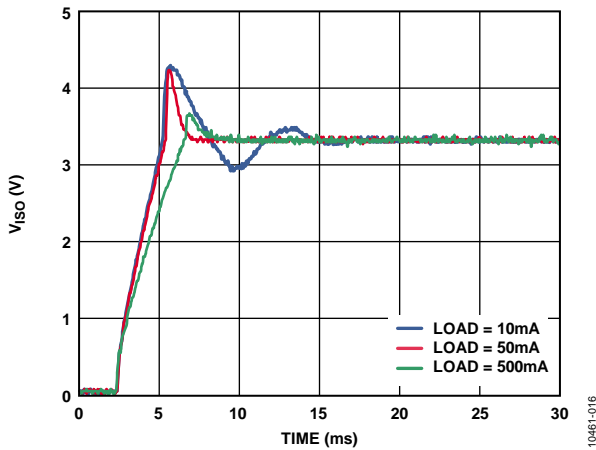

Figure 16. Typical V_{ISO} Startup with 10 mA, 50 mA, and 500 mA Output Load, 5 V Input to 3.3 V Output

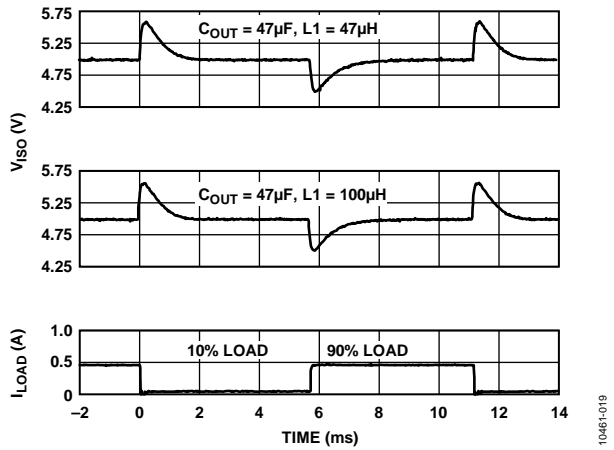

Figure 19. Typical V_{ISO} Load Transient Response at 10% to 90% of 500 mA Load, $f_{SW} = 500$ kHz, 5 V Input to 5 V Output

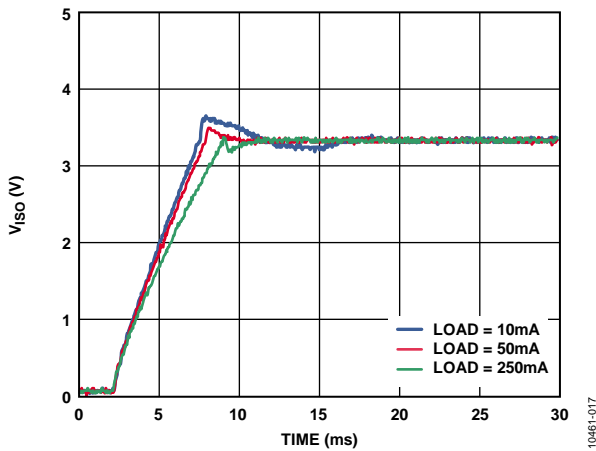

Figure 17. Typical V_{ISO} Startup with 10 mA, 50 mA, and 250 mA Output Load, 3.3 V Input to 3.3 V Output

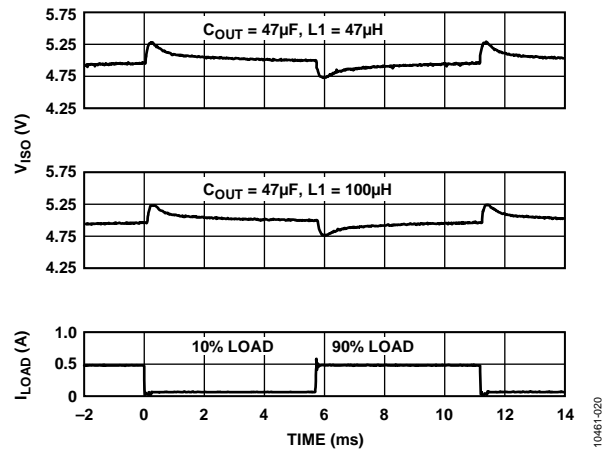

Figure 20. Typical V_{ISO} Load Transient Response at 10% to 90% of 500 mA Load with 0.1 μ F Feedback Capacitor, $f_{SW} = 500$ kHz, 5 V Input to 5 V Output

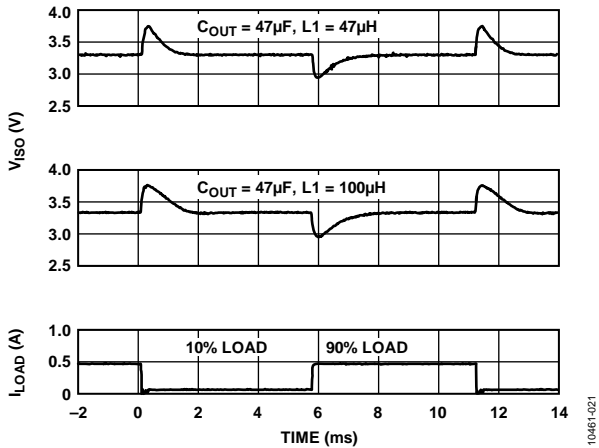

Figure 21. Typical V_{ISO} Load Transient Response at 10% to 90% of 500 mA Load, $f_{SW} = 500$ kHz, 5 V Input to 3.3 V Output

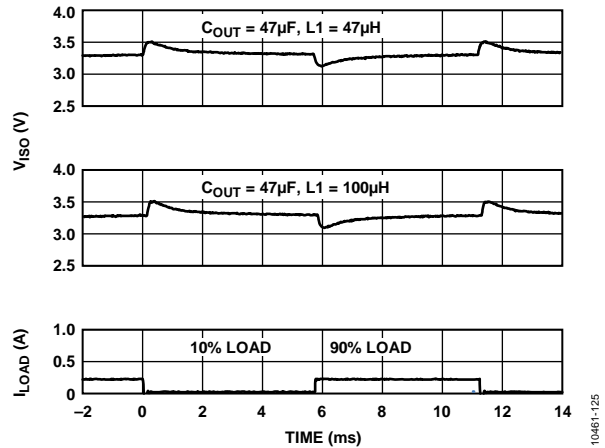

Figure 24. Typical V_{ISO} Load Transient Response at 10% to 90% of 250 mA Load with 0.1 μ F Feedback Capacitor, $f_{SW} = 500$ kHz, 3.3 V Input to 3.3 V Output

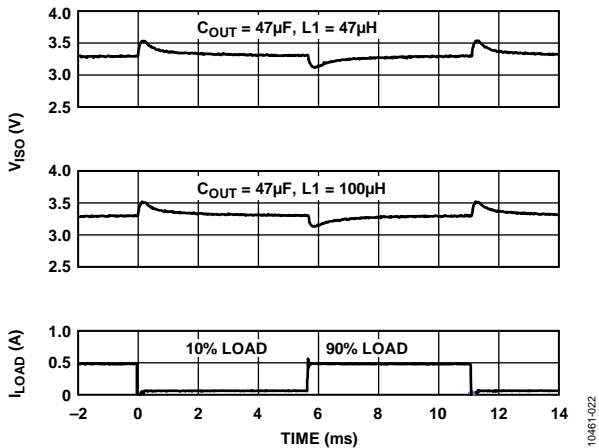

Figure 22. Typical V_{ISO} Load Transient Response at 10% to 90% of 500 mA Load with 0.1 μ F Feedback Capacitor, $f_{SW} = 500$ kHz, 5 V Input to 3.3 V Output

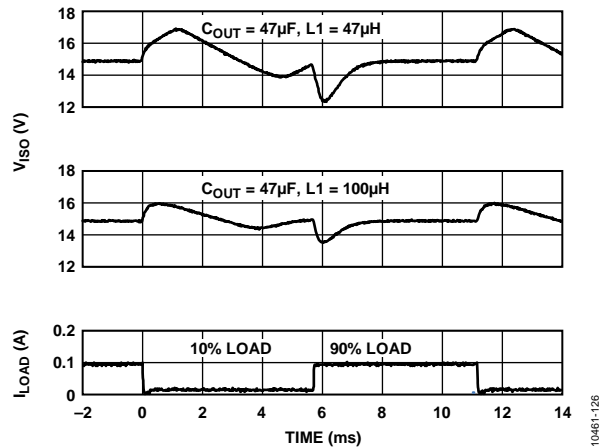

Figure 25. Typical V_{ISO} Load Transient Response at 10% to 90% of 100 mA Load, $f_{SW} = 500$ kHz, 5 V Input to 15 V Output

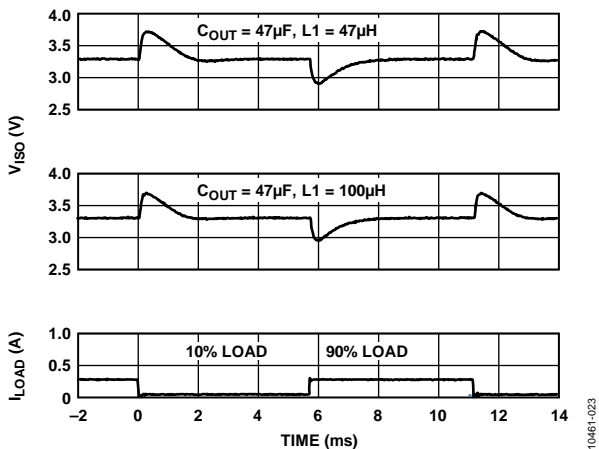

Figure 23. Typical V_{ISO} Load Transient Response at 10% to 90% of 250 mA Load, $f_{SW} = 500$ kHz, 3.3 V Input to 3.3 V Output

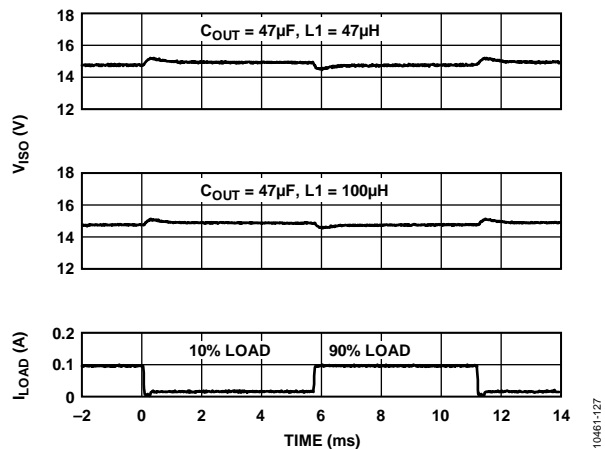

Figure 26. Typical V_{ISO} Load Transient Response at 10% to 90% of 100 mA Load with 0.1 μ F Feedback Capacitor, $f_{SW} = 500$ kHz, 5 V Input to 15 V Output

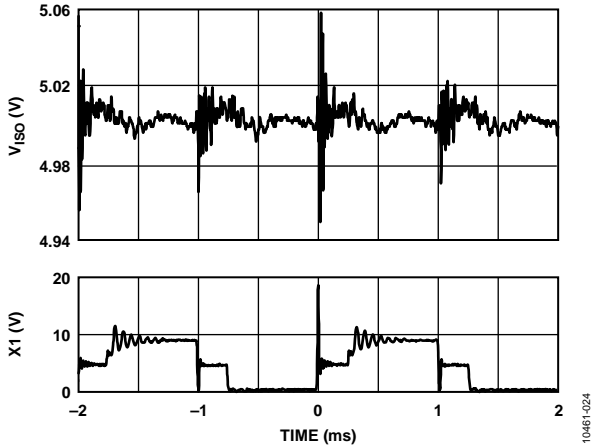

Figure 27. Typical V_{ISO} Output Voltage Ripple at 500 mA Load, $f_{SW} = 500$ kHz, 5 V Input to 5 V Output

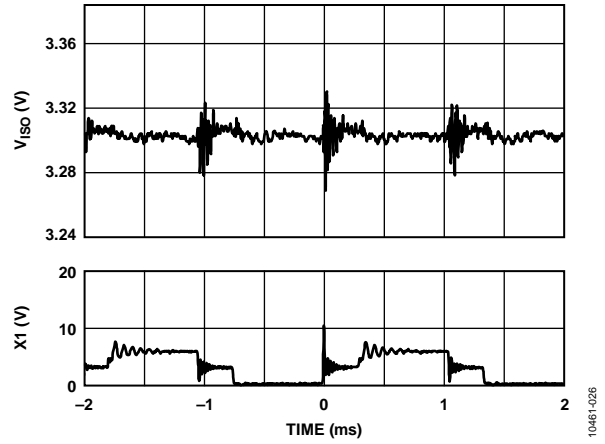

Figure 29. Typical V_{ISO} Output Voltage Ripple at 250 mA Load, $f_{SW} = 500$ kHz, 3.3 V Input to 3.3 V Output

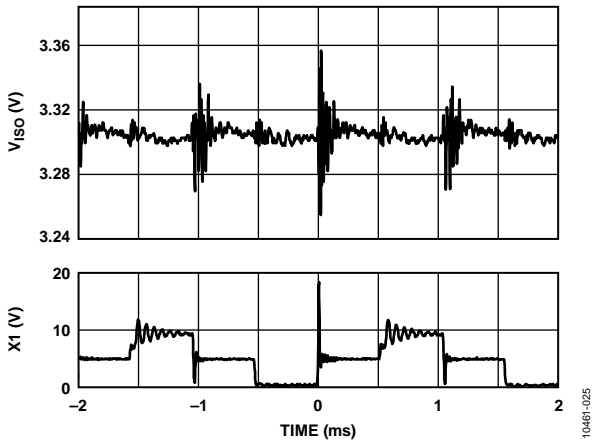

Figure 28. Typical V_{ISO} Output Voltage Ripple at 500 mA Load, $f_{SW} = 500$ kHz, 5 V Input to 3.3 V Output

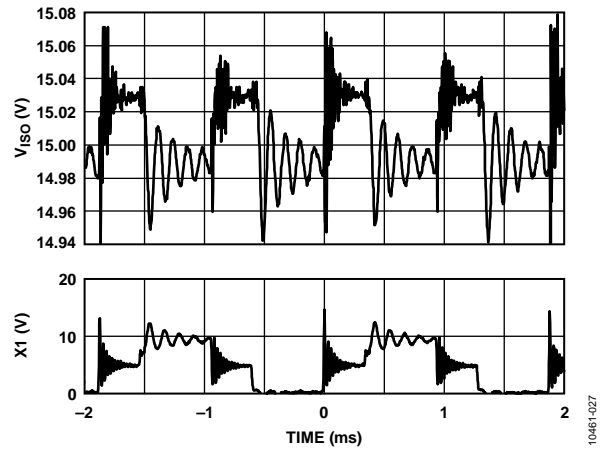

Figure 30. Typical V_{ISO} Output Voltage Ripple at 100 mA Load, $f_{SW} = 500$ kHz, 5 V Input to 15 V Output

APPLICATIONS INFORMATION

The dc-to-dc converter section of the ADuM4070 uses a secondary side controller architecture with isolated pulse-width modulation (PWM) feedback. V_{DD1} power is supplied to an oscillating circuit that switches current to the primary side of an external power transformer using internal push-pull switches at the X1 and X2 pins. Power transferred to the secondary side of the transformer is full wave rectified with external Schottky diodes (D1 and D2), filtered with the L1 inductor and C_{OUT} capacitor, and regulated to the isolated power supply voltage from 3.3 V to 15 V. The secondary (V_{ISO}) side controller regulates the output using a feedback voltage, V_{FB} , from a resistor divider on the output to create a PWM control signal that is sent to the primary (V_{DD1}) side by a dedicated iCoupler data channel labeled V_{FB} . The primary side PWM converter varies the duty cycle of the X1 and X2 switches to modulate the oscillator circuit and control the power being sent to the secondary side. This feedback allows for significantly higher power and efficiency.

The ADuM4070 implements undervoltage lockout (UVLO) with hysteresis on the V_{DDA} power input. This feature ensures that the converter does not go into oscillation due to noisy input power or slow power-on ramp rates.

A minimum load current of 10 mA is recommended to ensure optimum load regulation. Smaller loads can generate excess noise on the output because of short or erratic PWM pulses. Excess noise generated in this way can cause regulation problems in some circumstances.

APPLICATION SCHEMATICS

The ADuM4070 has three main application schematics, as shown in Figure 31 to Figure 33. Figure 31 has a center-tapped secondary and two Schottky diodes that provide full wave rectification for a single output, typically for power supplies of 3.3 V, 5 V, 12 V, and 15 V. For single supplies when $V_{ISO} = 3.3$ V or 5 V, V_{REG} , V_{DD2} , and V_{ISO} can be connected together.

Figure 32 shows a voltage doubling circuit that can be used for a single supply with an output that exceeds 15 V; 15 V is the largest supply that can be connected to the regulator input, V_{REG} (Pin 16). In the circuit shown in Figure 32, the output voltage can be as high as 24 V, and the voltage at the V_{REG} pin can be as high as 12 V. When using the circuit shown in Figure 32 to obtain an output voltage lower than 10 V (for example, $V_{DD1} = 3.3$ V, $V_{ISO} = 5$ V), connect V_{REG} to V_{ISO} directly.

Figure 33, which also uses a voltage doubling secondary circuit, is an example of a coarsely regulated, positive power supply and an unregulated, negative power supply for outputs of approximately ± 5 V, ± 12 V, and ± 15 V.

For all the circuits shown in Figure 31 to Figure 33, the isolated output voltage (V_{ISO}) can be set with the voltage dividers, R1 and R2 (values 1 k Ω to 100 k Ω) using the following equation:

$$V_{ISO} = V_{FB} \times (R1 + R2)/R2$$

where V_{FB} is the internal feedback voltage (approximately 1.25 V).

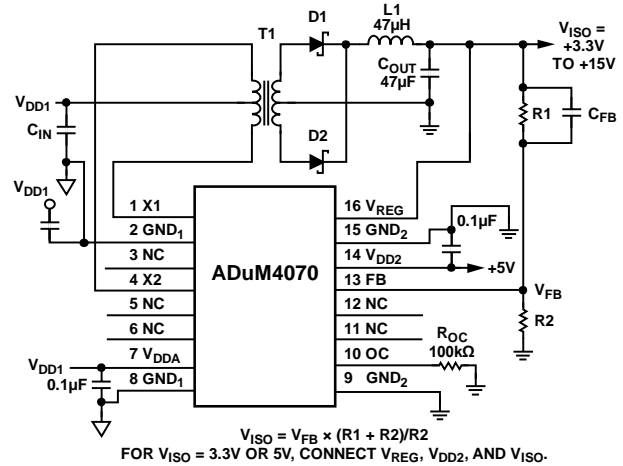

Figure 31. Single Power Supply

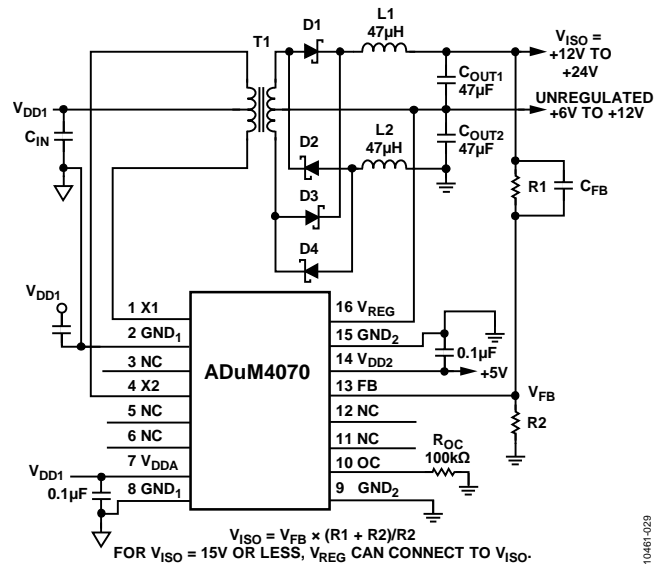

Figure 32. Doubling Power Supply

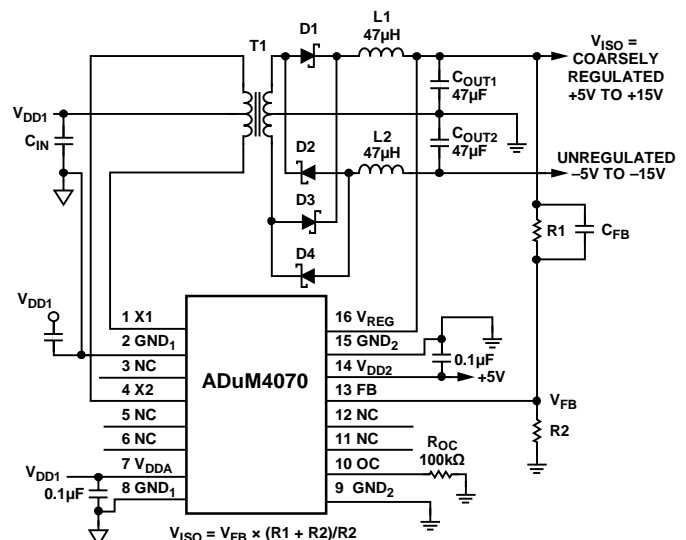

Figure 33. Positive Supply and Unregulated Negative Supply

TRANSFORMER DESIGN

Custom transformers were designed for use in the circuits shown in Figure 31, Figure 32, and Figure 33 (see Table 13). The transformers designed for use with the ADuM4070 differ from other transformers used with isolated dc-to-dc converters that do not regulate the output voltage. The output voltage is regulated by a PWM controller in the ADuM4070 that varies the duty cycle of the primary side switches in response to a secondary side feedback voltage, V_{FB} , received through an isolated digital channel. The internal controller has a maximum duty cycle of 40%.

TRANSFORMER TURNS RATIO

To determine the transformer turns ratio—taking into account the losses for the primary switches and the losses for the secondary diodes and inductors—the external transformer turns ratio for the ADuM4070 can be calculated using Equation 1.

$$\frac{N_s}{N_p} = \frac{V_{ISO} + V_D}{V_{DD1(MIN)} \times D \times 2} \quad (1)$$

where:

N_s/N_p is the primary to secondary turns ratio.

V_{ISO} is the isolated output supply voltage.

V_D is the Schottky diode voltage drop (0.5 V maximum).

$V_{DD1(MIN)}$ is the minimum input supply voltage.

D is the duty cycle = 0.30 for a 30% typical duty cycle (40% is the maximum duty cycle).

2 is a multiplier factor used for the push-pull switching cycle.

For the circuit shown in Figure 31 using the 5 V to 5 V reference design in Table 13 and with $V_{DD1(MIN)} = 4.5$ V, the turns ratio is $N_s/N_p = 2$.

For a 3.3 V input to 3.3 V output isolated single power supply and with $V_{DD1(MIN)} = 3.0$ V, the turns ratio is also $N_s/N_p = 2$. Therefore, the same transformer turns ratio, $N_s/N_p = 2$, can be used for the three single power applications: 5 V to 5 V, 5 V to 3.3 V, and 3.3 V to 3.3 V.

The circuit shown in Figure 32 uses double windings and diode pairs to create a doubler circuit; therefore, half the output voltage, $V_{ISO}/2$, is used, as shown in Equation 2.

$$\frac{N_s}{N_p} = \frac{\frac{V_{ISO}}{2} + V_D}{V_{DD1(MIN)} \times D \times 2} \quad (2)$$

where:

N_s/N_p is the primary to secondary turns ratio.

V_{ISO} is the isolated output supply voltage. $V_{ISO}/2$ is used because the circuit uses two pairs of diodes, creating a doubler circuit.

V_D is the Schottky diode voltage drop (0.5 V maximum).

$V_{DD1(MIN)}$ is the minimum input supply voltage.

D is the duty cycle = 0.30 for a 30% typical duty cycle (40% is the maximum duty cycle).

2 is a multiplier factor used for the push-pull switching cycle.

For the circuit shown in Figure 32 using the 5 V to 15 V reference design in Table 13 and with $V_{DD1(MIN)} = 4.5$ V, the turns ratio is $N_s/N_p = 3$.

The circuit shown in Figure 33 also uses double windings and diode pairs to create a doubler circuit. However, because a positive and negative output voltage are created, the external transformer turns ratio can be calculated using Equation 3.

$$\frac{N_s}{N_p} = \frac{V_{ISO} + V_D}{V_{DD1(MIN)} \times D \times 2} \quad (3)$$

For the circuit shown in Figure 33, the duty cycle, D , is set to 0.35 for a 35% typical duty cycle to reduce the maximum voltages seen by the diodes for a ± 15 V supply.

For the circuit shown in Figure 33 using the +5 V to ± 15 V reference design in Table 13 and with $V_{DD1(MIN)} = 4.5$ V, the turns ratio is $N_s/N_p = 5$.

TRANSFORMER ET CONSTANT

The next transformer design factor to consider is the ET constant. This constant determines the minimum $V \times \mu s$ constant of the transformer over the operating temperature. ET values of $14 V \times \mu s$ and $18 V \times \mu s$ were selected for the ADuM4070 transformer designs listed in Table 13 using the following equation:

$$ET(MIN) = \frac{V_{DD1(MAX)}}{f_{SW(MIN)} \times 2}$$

where:

$V_{DD1(MAX)}$ is the maximum input supply voltage.

$f_{SW(MIN)}$ is the minimum primary switching frequency = 300 kHz in startup.

2 is a multiplier factor used for the push-pull switching cycle.

Table 13. Transformer Reference Designs

Part No.	Manufacturer	Turns Ratio, PRI:SEC	ET Constant ($V \times \mu s$ min)	Total Primary Inductance (μH)	Total Primary Resistance (Ω)	Isolation Voltage (rms)	Isolation Type	Reference
CR7983-CL	Coilcraft	1CT:2CT	18	256	0.4	5000	Reinforced	Figure 31
CR7984-CL	Coilcraft	1CT:3CT	18	256	0.4	5000	Reinforced	Figure 32
CR7985-CL	Coilcraft	1CT:5CT	18	256	0.4	5000	Reinforced	Figure 33
TGSAD-560V8LF	Halo Electronics	1CT:2CT	14	398	0.8	5000	Supplemental	Figure 31
TGSAD-590V8LF	Halo Electronics	1CT:3CT	14	398	0.8	5000	Supplemental	Figure 32

TRANSFORMER PRIMARY INDUCTANCE AND RESISTANCE

Another important characteristic of the transformer for designs with the ADuM4070 is the primary inductance. Transformers for the ADuM4070 are recommended to have between 60 μH to 100 μH of inductance per primary winding. Values of primary inductance in this range are needed for smooth operation of the ADuM4070 pulse-by-pulse current-limit circuit, which can help protect against a build-up of saturation currents in the transformer. If the inductance is specified for the total of both primary windings, for example, as 400 μH , the inductance of one winding is $\frac{1}{2}$ of two equal windings, or 100 μH .

Another important characteristic of the transformer for designs with the ADuM4070 is primary resistance. Primary resistance as low as is practical (less than 1 Ω) helps to reduce losses and improves efficiency. The dc primary resistance can be measured and specified, and is shown for the transformers in Table 13.

TRANSFORMER ISOLATION VOLTAGE

Isolation voltage and isolation type should be determined for the requirements of the application and then specified. The transformers listed in Table 13 have been specified at 5000 V rms for reinforced isolation. Other isolation levels and isolation voltages can be specified and requested from the transformer manufacturers listed in Table 13 or from other manufacturers.

SWITCHING FREQUENCY

The ADuM4070 switching frequency can be adjusted from 200 kHz to 1 MHz by changing the value of the R_{OC} resistor shown in Figure 31, Figure 32, and Figure 33. The value of the R_{OC} resistor needed for the desired switching frequency can be determined from the switching frequency vs. R_{OC} resistance curve shown in Figure 4. The output filter inductor value and output capacitor value for the ADuM4070 application schematics have been designed to be stable over the switching frequency range of 500 kHz to 1 MHz, when loaded from 10% to 90% of the maximum load.

The ADuM4070 also has an open-loop mode where the output voltage is not regulated and is dependent on the transformer turns ratio (N_s/N_p) and the conditions of the output including output load current and the losses in the dc-to-dc converter circuit. This open-loop mode is selected when the OC pin is connected high to the V_{DD2} pin. In open-loop mode, the switching frequency is 318 kHz.

TRANSIENT RESPONSE

The load transient response of the ADuM4070 output voltage for 10% to 90% of the full load is shown in Figure 19 to Figure 26 for the application schematics in Figure 31 and Figure 32. The response shown is slow but stable and can have more output change than desired for some applications. The output voltage change with load transient is reduced, and the output is shown to remain stable by adding more inductance to the output circuits, as shown in the second V_{ISO} output waveform in Figure 19 to Figure 26.

For additional improvement in transient response, add a 0.1 μF ceramic capacitor (C_{FB}) in parallel with the high feedback resistor (see Figure 31 to Figure 33). This value helps to reduce the overshoot and undershoot during load transients.

COMPONENT SELECTION

Power supply bypassing is required at the input and output supply pins. Note that a low ESR ceramic bypass capacitor of 0.1 μF is required on Side 1 between Pin 7 and Pin 8, and on Side 2 between Pin 14 and Pin 15, as close to the chip pads as possible.

The power supply section of the ADuM4070 uses a high oscillator frequency to efficiently pass power through the external power transformer. Bypass capacitors are required for several operating frequencies. Noise suppression requires a low inductance, high frequency capacitor; ripple suppression and proper regulation require a large value capacitor. To suppress noise and reduce ripple, large value ceramic capacitors of X5R or X7R dielectric type are recommended. The recommended capacitor value is 10 μF for V_{DD1} and 47 μF for V_{ISO} . These capacitors have a low ESR and are available in moderate 1206 or 1210 sizes for voltages up to 10 V. For output voltages larger than 10 V, two 22 μF ceramic capacitors can be used in parallel. See Table 14 for recommended components.

Table 14. Recommended Components

Part No.	Manufacturer	Value
GRM32ER71A476KE15L	Murata	47 μF , 10 V, X7R, 1210
GRM32ER71C226KEA8L	Murata	22 μF , 16 V, X7R, 1210
GRM31CR71A106KA01L	Murata	10 μF , 10 V, X7R, 1206
MBR0540T1G	ON Semiconductor	Schottky, 0.5 A, 40 V, SOD-123
LQH3NPN470MM0	Murata	47 μH , 0.41 A, 1212
ME3220-104KL	Coilcraft	100 μH , 0.34 A, 1210
LQH6PPN470M43	Murata	47 μH , 1.10 A, 2424
LQH6PPN101M43	Murata	100 μH , 0.80 A, 2424

Inductors must be selected based on the value and supply current needed. Most applications with switching frequencies between 500 kHz and 1 MHz and load transients between 10% and 90% of full load are stable with the 47 μH inductor value listed in Table 14. Values as large as 200 μH can be used for power supply applications with a switching frequency as low as 200 kHz to help stabilize the output voltage or for improved load transient response (see Figure 19 to Figure 26). Inductors in a small 1212 or 1210 size are listed in Table 14 with a 47 μH value and a 0.41 A current rating to handle the majority of applications below a 400 mA load, and with a 100 μH value and a 0.34 A current rating to handle a load up to 300 mA.

Recommended Schottky diodes have low forward voltage to reduce losses and high reverse voltage of up to 40 V to withstand the peak voltages available in the doubling circuits shown in Figure 32 and Figure 33.

PRINTED CIRCUIT BOARD (PCB) LAYOUT

Figure 34 shows the recommended PCB layout for the ADuM4070. Note that the total lead length between the ends of the low ESR capacitor and the V_{DDx} and GND_x pins must not exceed 2 mm.

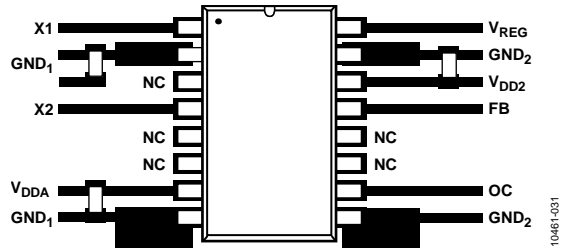

Figure 34. Recommended PCB Layout

In applications that involve high common-mode transients, ensure that board coupling across the isolation barrier is minimized. Furthermore, design the board layout such that any coupling that does occur affects all pins equally on a given component side. Failure to ensure this can cause voltage differentials between pins that exceed the absolute maximum ratings specified in Table 10, thereby leading to latch-up and/or permanent damage.

The ADuM4070 is a power device that dissipates approximately 1 W of power when fully loaded and running at maximum speed. Because it is not possible to apply a heat sink to an isolation device, the device primarily depends on heat dissipation into the PCB through the GND pins. If the device is used at high ambient temperatures, provide a thermal path from the GNDx pins to the PCB ground plane. The board layout in Figure 34 shows enlarged pads for Pin 2 and Pin 8 (GND_1) on Side 1 and Pin 9 and Pin 15 (GND_2) on Side 2. Large diameter vias should be implemented from the pad to the ground planes and power planes to increase thermal conductivity and to reduce inductance. Multiple vias in the thermal pads can significantly reduce temperatures inside the chip. The dimensions of the expanded pads are left to the discretion of the designer and depend on the available board space.

THERMAL ANALYSIS

The ADuM4070 consists of two internal die attached to a split lead frame with two die attach paddles. For the purposes of thermal analysis, the die are treated as a thermal unit, with the highest junction temperature reflected in the θ_{JA} value from Table 5. The value of θ_{JA} is based on measurements taken with the part mounted on a JEDEC standard, 4-layer board with fine width traces and still air.

Under normal operating conditions, the ADuM4070 operates at full load across the full temperature range without derating the output current. However, following the recommendations in the Printed Circuit Board (PCB) Layout section decreases thermal resistance to the PCB, allowing increased thermal margins at high ambient temperatures.

The ADuM4070 has a thermal shutdown circuit that shuts down the dc-to-dc converter of the ADuM4070 when a die temperature of approximately 160°C is reached. When the die cools below approximately 140°C, the ADuM4070 dc-to-dc converter and outputs turn on again.

POWER CONSUMPTION

The total input supply current is equal to the sum of the I_{DD1} primary transformer current and the ADuM4070 input current, I_{DDA} (see Figure 35).

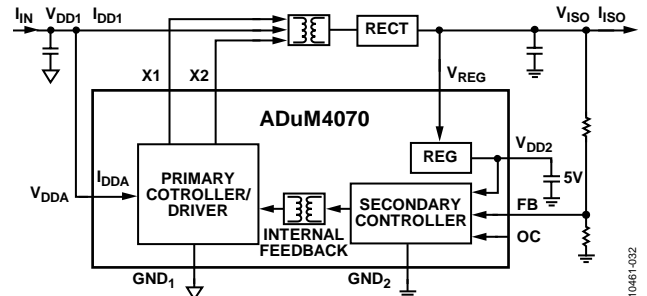

Figure 35. Power Consumption Within the ADuM4070

The total I_{IN} current can be calculated as follows:

$$I_{IN} = (I_{ISO} \times V_{ISO}) / (E \times V_{DD1})$$

where:

I_{IN} is the total supply input current.

I_{ISO} is the current drawn by the secondary side external load.

E is the power supply efficiency at the given output load from Figure 8 or Figure 14 at the V_{ISO} and V_{DD1} condition of interest.

POWER CONSIDERATIONS

Soft Start Mode and Current-Limit Protection

When the ADuM4070 first receives power from V_{DD1} , it is in soft start mode, and the output voltage, V_{ISO} , is increased gradually while it is below the startup threshold. In soft start mode, the width of the PWM signal is increased gradually by the primary converter to limit the peak current during V_{ISO} power-up. When the output voltage is larger than the startup threshold, the PWM signal can be transferred from the secondary controller to the primary converter, and the dc-to-dc converter switches from soft start mode to the normal PWM control mode.

If a short circuit occurs, the push-pull converter shuts down for approximately 2 ms and then enters soft start mode. If, at the end of soft start, a short circuit still exists, the process is repeated, which is called hiccup mode. If the short circuit is cleared, the ADuM4070 enters normal operation.

The ADuM4070 also has a pulse-by-pulse current limit, which is active in startup and normal operation, and protects the primary switches, X1 and X2, from exceeding approximately 1.3 A peak and also protects the transformer windings.

INSULATION LIFETIME

All insulation structures eventually break down when subjected to voltage stress over a sufficiently long period. The rate of insulation degradation is dependent on the characteristics of the voltage waveform applied across the insulation. In addition to the testing performed by the regulatory agencies, Analog Devices, Inc., conducts an extensive set of evaluations to determine the lifetime of the insulation structure within the [ADuM4070](#).

Analog Devices performs accelerated life testing using voltage levels higher than the rated continuous working voltage. Acceleration factors for several operating conditions are determined, allowing calculation of the time to failure at the working voltage of interest. The values shown in Table 11 summarize the peak voltages for 50 years of service life in several operating conditions. In many cases, the working voltage approved by agency testing is higher than the 50-year service life voltage. Operation at working voltages higher than the service life voltage listed in Table 11 can lead to premature insulation failure.

The insulation lifetime of the [ADuM4070](#) depends on the voltage waveform type imposed across the isolation barrier. The *iCoupler* insulation structure degrades at different rates, depending on whether the waveform is bipolar ac, unipolar ac, or dc. Figure 36, Figure 37, and Figure 38 illustrate these different isolation voltage waveforms.

Bipolar ac voltage is the most stringent environment. The goal of a 50-year operating lifetime under the bipolar ac condition determines the maximum working voltage recommended by Analog Devices.

In the case of unipolar ac or dc voltage, the stress on the insulation is significantly lower. This allows operation at higher working voltages while still achieving a 50-year service life. The working voltages listed in Table 11 can be applied while maintaining the 50-year minimum lifetime, provided that the voltage conforms to either the unipolar ac or dc voltage cases. Treat any cross-insulation voltage waveform that does not conform to Figure 37 or Figure 38 as a bipolar ac waveform, and limit its peak voltage to the 50-year lifetime voltage value listed in Table 11.

The voltage presented in Figure 37 is shown as sinusoidal for illustration purposes only. It is meant to represent any voltage waveform varying between 0 V and some limiting value. The limiting value can be positive or negative, but the voltage cannot cross 0 V.

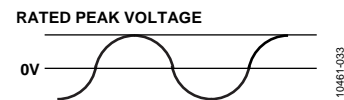

Figure 36. Bipolar AC Waveform

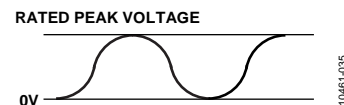

Figure 37. Unipolar AC Waveform

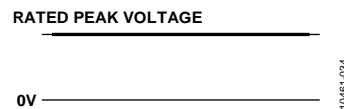
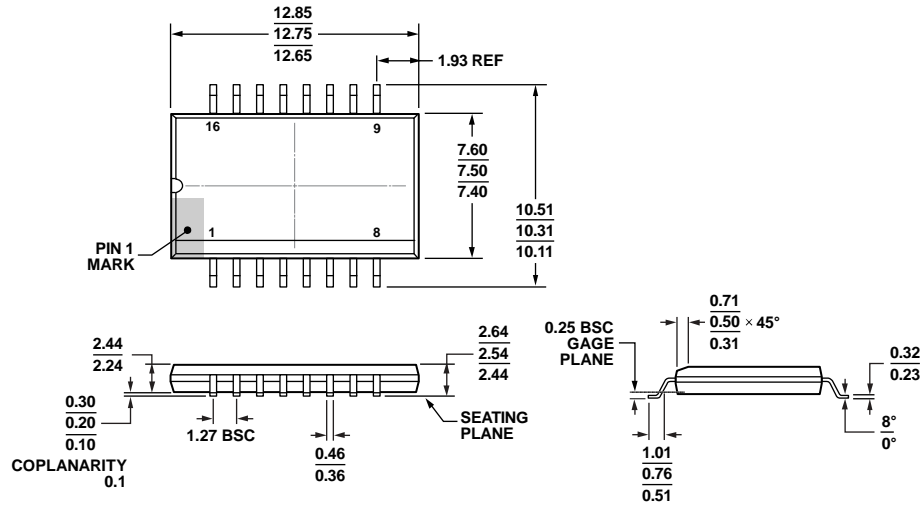

Figure 38. DC Waveform

OUTLINE DIMENSIONS



COMPLIANT TO JEDEC STANDARDS MS-013-AC

Figure 39. 16-Lead Standard Small Outline Package, with Increased Creepage [SOIC_IC]
Wide Body
(RI-16-2)
Dimensions shown in millimeters

ORDERING GUIDE

Model ¹	Temperature Range	Package Description	Package Option	Ordering Quantity
ADuM4070ARIZ	-40°C to +105°C	16-Lead SOIC_IC	RI-16-2	1,000
ADuM4070ARIZ-RL	-40°C to +105°C	16-Lead SOIC_IC	RI-16-2	

¹ Z = RoHS Compliant Part.

NOTES