

LT1366/LT1367 LT1368/LT1369

ABSOLUTE MAXIMUM RATINGS (Note 1)

Total Supply Voltage (V^+ to V^-)	36V	Specified Temperature Range	0°C to 70°C
Input Current.....	$\pm 15\text{mA}$	Junction Temperature	150°C
Output Short-Circuit Duration (Note 2).....	Continuous	Storage Temperature Range	-65°C to 150°C
Operating Temperature Range	-40°C to 85°C	Lead Temperature (Soldering, 10 sec).....	300°C

PIN CONFIGURATION

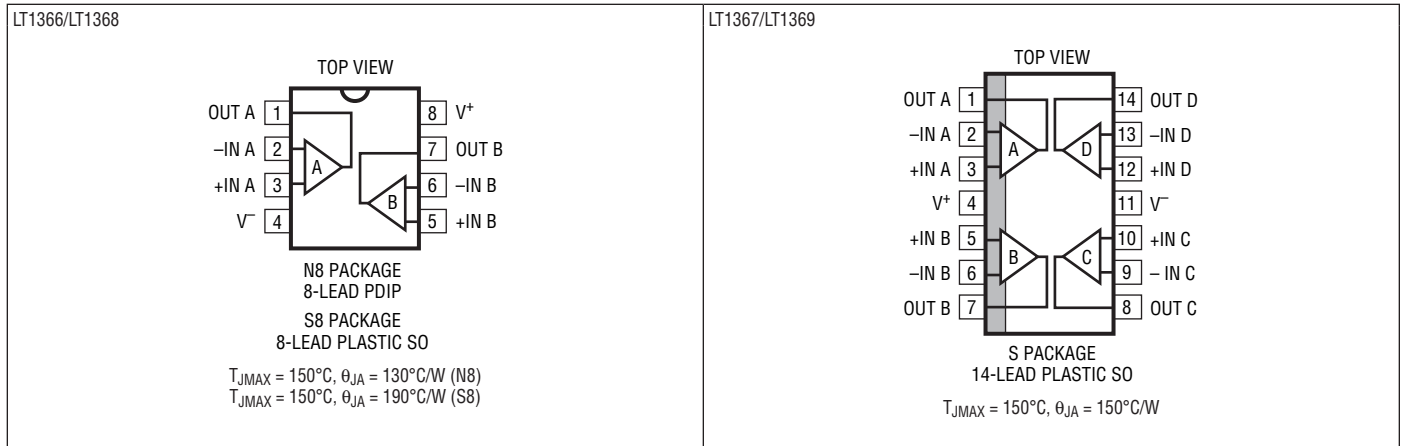

AVAILABLE OPTIONS

PRODUCT NUMBER	NUMBER OF OP AMPS	LOAD CAPACITANCE	MAX V_{OS} (25°C) AT $V_S = 5\text{V}$, 0V	ORDER PART NUMBER	
				PLASTIC (N)	SURFACE MOUNT(S)
LT1366	2	$0\text{pF} < C_L < 1000\text{pF}$	475 μV	LT1366CN8	LT1366CS8
LT1367	4	$0\text{pF} < C_L < 1000\text{pF}$	800 μV		LT1367CS
LT1368	2	$C_L = 0.1\mu\text{F}$	475 μV	LT1368CN8	LT1368CS8
LT1369	4	$C_L = 0.1\mu\text{F}$	800 μV		LT1369CS

ORDER INFORMATION

LEAD FREE FINISH	TAPE AND REEL	PART MARKING	PACKAGE DESCRIPTION	SPECIFIED TEMPERATURE RANGE
LT1366CN8#PBF	LT1366CN8#TRPBF	1366	8-Lead PDIP	0°C to 70°C
LT1366CS8#PBF	LT1366CS8#TRPBF	1366	8-Lead Plastic SO	0°C to 70°C
LT1367CS#PBF	LT1367CS#TRPBF	LT1367CS	14-Lead Plastic SO	0°C to 70°C
LT1368CN8#PBF	LT1368CN8#TRPBF	1368	8-Lead PDIP	0°C to 70°C
LT1368CS8#PBF	LT1368CS8#TRPBF	1368	8-Lead Plastic SO	0°C to 70°C
LT1369CS#PBF	LT1369CS#TRPBF	LT1369CS	14-Lead Plastic SO	0°C to 70°C

Consult LTC Marketing for parts specified with wider operating temperature ranges.

Consult LTC Marketing for information on non-standard lead based finish parts.

For more information on lead free part marking, go to: <http://www.linear.com/leadfree/>

For more information on tape and reel specifications, go to: <http://www.linear.com/tapeandreel/>

ELECTRICAL CHARACTERISTICS $T_A = 25^\circ\text{C}$; $V_S = 5\text{V}$, 0V ; $V_{CM} = 2.5\text{V}$; $V_O = 2.5\text{V}$, unless otherwise noted.

SYMBOL	PARAMETER	CONDITIONS	MIN	TYP	MAX	UNITS
V_{OS}	Input Offset Voltage (LT1366/LT1368)	$V_{CM} = V_{CC}$ $V_{CM} = V_{EE}$		150 150	475 475	μV μV
	Input Offset Voltage (LT1367/LT1369)	$V_{CM} = V_{CC}$ $V_{CM} = V_{EE}$		150 150	800 700	μV μV
ΔV_{OS}	Input Offset Voltage Shift (LT1366/LT1368)	$V_{CM} = V_{EE}$ to V_{CC}		150	400	μV
	Input Offset Voltage Match (Channel to Channel)	$V_{CM} = V_{EE}$, V_{CC} (Notes 4, 5)		250	700	μV
	Input Offset Voltage Shift (LT1367/LT1369)	$V_{CM} = V_{EE}$ to V_{CC}		150	650	μV
	Input Offset Voltage Match (Channel to Channel)	$V_{CM} = V_{EE}$, V_{CC} (Notes 4, 5)		250	1600	μV
I_B	Input Bias Current	$V_{CM} = V_{CC}$ $V_{CM} = V_{EE}$	0 -35	10 -10	35 0	nA nA
ΔI_B	Input Bias Current Shift	$V_{CM} = V_{EE}$ to V_{CC}		20	70	nA
I_{OS}	Input Offset Current	$V_{CM} = V_{CC}$ $V_{CM} = V_{EE}$		1 0.3	12 12	nA nA
	Input Offset Current Shift	$V_{CM} = V_{EE}$ to V_{CC}		1	12	nA
ΔI_{OS}	Input Bias Current Match (Channel to Channel)	$V_{CM} = V_{CC}$ (Note 4) $V_{CM} = V_{EE}$ (Note 4)	0 0	1 1	12 12	nA nA
	Input Noise Voltage Density	$f = 1\text{kHz}$		29		$\text{nV}/\sqrt{\text{Hz}}$
i_n	Input Noise Current Density	$f = 1\text{kHz}$		0.07		$\text{pA}/\sqrt{\text{Hz}}$
C_{IN}	Input Capacitance			12		pF
A_{VOL}	Large-Signal Voltage Gain	$V_O = 50\text{mV}$ to 4.8V , $R_L = 10\text{k}$	250	2000		V/mV
CMRR	Common Mode Rejection Ratio (LT1366/LT1368)	$V_{CM} = V_{EE}$ to V_{CC}	81	90		dB
	CMRR Match (Channel to Channel)	$V_{CM} = V_{EE}$ to V_{CC} (Note 4)	75	90		dB
	Common Mode Rejection Ratio (LT1367/LT1369)	$V_{CM} = V_{EE}$ to V_{CC}	77	90		dB
	CMRR Match (Channel to Channel)	$V_{CM} = V_{EE}$ to V_{CC} (Note 4)	71	90		dB
PSRR	Power Supply Rejection Ratio	$V_S = 2.0\text{V}$ to 12V , $V_{CM} = V_O = 0.5\text{V}$	90	105		dB
	PSRR Match (Channel to Channel) (Note 4)	$V_S = 2.0\text{V}$ to 12V , $V_{CM} = V_O = 0.5\text{V}$	84	100		dB
V_{OL}	Output Voltage Swing Low	No Load		6	12	mV
		$I_{SINK} = 0.5\text{mA}$		40	70	mV
		$I_{SINK} = 2.5\text{mA}$		110	200	mV
V_{OH}	Output Voltage Swing High	No Load	$V_{CC} - 0.012$	$V_{CC} - 0.004$		V
		$I_{SINK} = 0.5\text{mA}$	$V_{CC} - 0.100$	$V_{CC} - 0.050$		V
		$I_{SINK} = 2.5\text{mA}$	$V_{CC} - 0.250$	$V_{CC} - 0.150$		V
I_{SC}	Short-Circuit Current	(Note 2)	± 15	± 30		mA
I_S	Supply Current per Amplifier			340	520	μA
GBW	Gain-Bandwidth Product (LT1366/LT1367)	$A_V = 1000$		0.4		MHz
	Gain-Bandwidth Product (LT1368/LT1369)	$A_V = 1000$		0.16		MHz
t_S	Settling Time (LT1366/LT1367)	$A_V = 1$, $V_{STEP} = 4\text{V}$ to 0.1%		30		μs

LT1366/LT1367 LT1368/LT1369

ELECTRICAL CHARACTERISTICS

The ● denotes the specifications which apply over the specified temperature range of $0^{\circ}\text{C} < T_A < 70^{\circ}\text{C}$. $V_S = 5\text{V}$, 0V ; $V_{\text{CM}} = 2.5\text{V}$, $V_O = 2.5\text{V}$, unless otherwise noted.

SYMBOL	PARAMETER	CONDITIONS	MIN	TYP	MAX	UNITS	
V_{OS}	Input Offset Voltage (LT1366/LT1368)	$V_{\text{CM}} = V_{\text{CC}}$ $V_{\text{CM}} = V_{\text{EE}}$	● ●	200 200	575 575	μV μV	
	Input Offset Voltage (LT1367/LT1369)	$V_{\text{CM}} = V_{\text{CC}}$ $V_{\text{CM}} = V_{\text{EE}}$	● ●	200 200	950 900	μV μV	
$V_{\text{OS TC}}$	Input Offset Voltage Drift	(Note 3)	●	2	6	$\mu\text{V}/^{\circ}\text{C}$	
ΔV_{OS}	Input Offset Voltage Shift (LT1366/LT1368)	$V_{\text{CM}} = V_{\text{EE}}$ to V_{CC}	●	200	425	μV	
	Input Offset Voltage Match (Channel to Channel)	$V_{\text{CM}} = V_{\text{EE}}$, V_{CC} (Notes 4, 5)	●	250	900	μV	
	Input Offset Voltage Shift (LT1367/LT1369)	$V_{\text{CM}} = V_{\text{EE}}$ to V_{CC}	●	200	675	μV	
	Input Offset Voltage Match (Channel to Channel)	$V_{\text{CM}} = V_{\text{EE}}$, V_{CC} (Notes 4, 5)	●	250	1900	μV	
I_{B}	Input Bias Current	$V_{\text{CM}} = V_{\text{CC}}$	●	0	15	45	nA
		$V_{\text{CM}} = V_{\text{EE}}$	●	-45	-10	0	nA
ΔI_{B}	Input Bias Current Shift	$V_{\text{CM}} = V_{\text{EE}}$ to V_{CC}	●	25	90	nA	
I_{OS}	Input Offset Current	$V_{\text{CM}} = V_{\text{CC}}$	●	2	15	nA	
		$V_{\text{CM}} = V_{\text{EE}}$	●	1	15	nA	
ΔI_{OS}	Input Offset Current Shift	$V_{\text{CM}} = V_{\text{EE}}$ to V_{CC}	●	2	15	nA	
	Input Bias Current Match (Channel to Channel)	$V_{\text{CM}} = V_{\text{CC}}$ (Note 4) $V_{\text{CM}} = V_{\text{EE}}$ (Note 4)	● ●	0 0	2 1	15 15	nA nA
A_{VOL}	Large-Signal Voltage Gain	$V_O = 50\text{mV}$ to 4.8V , $R_L = 10\text{k}$	●	250	2000	V/mV	
CMRR	Common Mode Rejection Ratio (LT1366/LT1368)	$V_{\text{CM}} = V_{\text{EE}}$ to V_{CC}	●	80	87	dB	
	CMRR Match (Channel to Channel)	$V_{\text{CM}} = V_{\text{EE}}$ to V_{CC} (Note 4)	●	74	87	dB	
	Common Mode Rejection Ratio (LT1367/LT1369)	$V_{\text{CM}} = V_{\text{EE}}$ to V_{CC}	●	77	87	dB	
	CMRR Match (Channel to Channel)	$V_{\text{CM}} = V_{\text{EE}}$ to V_{CC} (Note 4)	●	71	87	dB	
PSRR	Power Supply Rejection Ratio	$V_S = 2.3\text{V}$ to 12V , $V_{\text{CM}} = V_O = 0.5\text{V}$	●	88	105	dB	
	PSRR Match (Channel to Channel) (Note 4)	$V_S = 2.3\text{V}$ to 12V , $V_{\text{CM}} = V_O = 0.5\text{V}$	●	82	100	dB	
V_{OL}	Output Voltage Swing Low	No Load	●	9	14	mV	
		$I_{\text{SINK}} = 0.5\text{mA}$	●	45	80	mV	
		$I_{\text{SINK}} = 2.5\text{mA}$	●	120	230	mV	
V_{OH}	Output Voltage Swing High	No Load	●	$V_{\text{CC}} - 0.014$	$V_{\text{CC}} - 0.005$	V	
		$I_{\text{SOURCE}} = 0.5\text{mA}$	●	$V_{\text{CC}} - 0.110$	$V_{\text{CC}} - 0.055$	V	
		$I_{\text{SOURCE}} = 2.5\text{mA}$	●	$V_{\text{CC}} - 0.300$	$V_{\text{CC}} - 0.180$	V	
I_{SC}	Short-Circuit Current	(Note 2)	●	± 12.5		mA	
I_{S}	Supply Current per Amplifier		●	385	540	μA	

$T_A = 25^{\circ}\text{C}$; $V_S = 3\text{V}$, 0V ; $V_{\text{CM}} = 1.5\text{V}$; $V_O = 1.5\text{V}$, unless otherwise noted.

SYMBOL	PARAMETER	CONDITIONS	MIN	TYP	MAX	UNITS	
V_{OS}	Input Offset Voltage (LT1366/LT1368)	$V_{\text{CM}} = V_{\text{CC}}$ $V_{\text{CM}} = V_{\text{EE}}$		150 150	475 475	μV μV	
	Input Offset Voltage (LT1367/LT1369)	$V_{\text{CM}} = V_{\text{CC}}$ $V_{\text{CM}} = V_{\text{EE}}$		150 150	850 750	μV μV	
ΔV_{OS}	Input Offset Voltage Shift (LT1366/LT1368)	$V_{\text{CM}} = V_{\text{EE}}$ to V_{CC}		150	400	μV	
	Input Offset Voltage Match (Channel to Channel)	$V_{\text{CM}} = V_{\text{EE}}$, V_{CC} (Notes 4, 5)		250	700	μV	
	Input Offset Voltage Shift (LT1367/LT1369)	$V_{\text{CM}} = V_{\text{EE}}$ to V_{CC}		150	650	μV	
	Input Offset Voltage Match (Channel to Channel)	$V_{\text{CM}} = V_{\text{EE}}$, V_{CC} (Notes 4, 5)		250	1700	μV	
I_{B}	Input Bias Current	$V_{\text{CM}} = V_{\text{CC}}$	●	0	10	35	nA
		$V_{\text{CM}} = V_{\text{EE}}$	●	-35	-10	0	nA
ΔI_{B}	Input Bias Current Shift	$V_{\text{CM}} = V_{\text{EE}}$ to V_{CC}		20	70	nA	
I_{OS}	Input Offset Current	$V_{\text{CM}} = V_{\text{CC}}$		1.0	12	nA	
		$V_{\text{CM}} = V_{\text{EE}}$		0.3	12	nA	

ELECTRICAL CHARACTERISTICS $T_A = 25^\circ\text{C}$; $V_S = 3\text{V}$, 0V ; $V_{CM} = 1.5\text{V}$; $V_O = 1.5\text{V}$, unless otherwise noted.

SYMBOL	PARAMETER	CONDITIONS	MIN	TYP	MAX	UNITS
ΔI_{OS}	Input Offset Current Shift	$V_{CM} = V_{EE}$ to V_{CC}		1	12	nA
	Input Bias Current Match (Channel to Channel)	$V_{CM} = V_{CC}$ (Note 4) $V_{CM} = V_{EE}$ (Note 4)	0 0	1 1	12 12	nA nA
A_{VOL}	Large-Signal Voltage Gain	$V_O = 50\text{mV}$ to 2.8V , $R_L = 10\text{k}$	250	1500		V/mV
CMRR	Common Mode Rejection Ratio (LT1366/LT1368) CMRR Match (Channel to Channel)	$V_{CM} = V_{EE}$ to V_{CC} $V_{CM} = V_{EE}$ to V_{CC} (Note 4)	77 71	86 86		dB dB
	Common Mode Rejection Ratio (LT1367/LT1369) CMRR Match (Channel to Channel)	$V_{CM} = V_{EE}$ to V_{CC} $V_{CM} = V_{EE}$ to V_{CC} (Note 4)	73 67	86 86		dB dB
V_{OL}	Output Voltage Swing Low	No Load		6	12	mV
		$I_{SINK} = 0.5\text{mA}$		40	70	mV
		$I_{SINK} = 2.5\text{mA}$		110	200	mV
V_{OH}	Output Voltage Swing High	No Load	$V_{CC} - 0.012$	$V_{CC} - 0.004$		V
		$I_{SINK} = 0.5\text{mA}$	$V_{CC} - 0.100$	$V_{CC} - 0.050$		V
		$I_{SINK} = 2.5\text{mA}$	$V_{CC} - 0.250$	$V_{CC} - 0.150$		V
I_{SC}	Short-Circuit Current	(Note 2)	± 10	± 20		mA
I_S	Supply Current per Amplifier			330	500	μA

The ● denotes the specifications which apply over the specified temperature range of $0^\circ\text{C} < T_A < 70^\circ\text{C}$. $V_S = 3\text{V}$, 0V ; $V_{CM} = 1.5\text{V}$, $V_O = 1.5\text{V}$, unless otherwise noted.

SYMBOL	PARAMETER	CONDITIONS	MIN	TYP	MAX	UNITS
V_{OS}	Input Offset Voltage (LT1366/LT1368)	$V_{CM} = V_{CC}$	●	200	575	μV
		$V_{CM} = V_{EE}$	●	200	575	μV
	Input Offset Voltage (LT1367/LT1369)	$V_{CM} = V_{CC}$	●	200	950	μV
		$V_{CM} = V_{EE}$	●	200	900	μV
ΔV_{OS}	Input Offset Voltage Shift (LT1366/LT1368) Input Offset Voltage Match (Channel to Channel)	$V_{CM} = V_{EE}$ to V_{CC}	●	200	425	μV
		$V_{CM} = V_{EE}$, V_{CC} (Notes 4, 5)	●	250	900	μV
	Input Offset Voltage Shift (LT1367/LT1369) Input Offset Voltage Match (Channel to Channel)	$V_{CM} = V_{EE}$ to V_{CC}	●	200	675	μV
		$V_{CM} = V_{EE}$, V_{CC} (Notes 4, 5)	●	250	1900	μV
$V_{OS\ TC}$	Input Offset Voltage Drift	(Note 3)	●	2	6	$\mu\text{V}/^\circ\text{C}$
I_B	Input Bias Current	$V_{CM} = V_{CC}$	●	0	15	nA
		$V_{CM} = V_{EE}$	●	-45	-10	0
ΔI_B	Input Bias Current Shift	$V_{CM} = V_{EE}$ to V_{CC}	●	25	90	nA
I_{OS}	Input Offset Current	$V_{CM} = V_{CC}$	●	2	15	nA
		$V_{CM} = V_{EE}$	●	1	15	nA
ΔI_{OS}	Input Offset Current Shift Input Bias Current Match (Channel to Channel)	$V_{CM} = V_{EE}$ to V_{CC}	●	2	15	nA
		$V_{CM} = V_{CC}$ (Note 4) $V_{CM} = V_{EE}$ (Note 4)	● ●	0 0	2 1	15 15
A_{VOL}	Large-Signal Voltage Gain	$V_O = 50\text{mV}$ to 2.8V , $R_L = 10\text{k}$	●	150	1500	V/mV
CMRR	Common Mode Rejection Ratio (LT1366/LT1368) CMRR Match (Channel to Channel)	$V_{CM} = V_{EE}$ to V_{CC}	●	76	83	dB
		$V_{CM} = V_{EE}$ to V_{CC} (Note 4)	●	70	83	dB
	Common Mode Rejection Ratio (LT1367/LT1369) CMRR Match (Channel to Channel)	$V_{CM} = V_{EE}$ to V_{CC}	●	72	83	dB
		$V_{CM} = V_{EE}$ to V_{CC} (Note 4)	●	66	83	dB
V_{OL}	Output Voltage Swing Low	No Load	●	9	14	mV
		$I_{SINK} = 0.5\text{mA}$	●	45	80	mV
		$I_{SINK} = 2.5\text{mA}$	●	120	230	mV
V_{OH}	Output Voltage Swing High	No Load	●	$V_{CC} - 0.014$	$V_{CC} - 0.005$	V
		$I_{SOURCE} = 0.5\text{mA}$	●	$V_{CC} - 0.110$	$V_{CC} - 0.055$	V
		$I_{SOURCE} = 2.5\text{mA}$	●	$V_{CC} - 0.300$	$V_{CC} - 0.180$	V
I_{SC}	Short-Circuit Current	(Note 2)	●	± 10		mA
I_S	Supply Current per Amplifier		●	375	520	μA

LT1366/LT1367 LT1368/LT1369

ELECTRICAL CHARACTERISTICS $T_A = 25^\circ\text{C}$, $V_S = \pm 15\text{V}$, $V_{CM} = 0\text{V}$, $V_O = 0\text{V}$, unless otherwise noted.

SYMBOL	PARAMETER	CONDITIONS	MIN	TYP	MAX	UNITS
V_{OS}	Input Offset Voltage (LT1366/LT1368)	$V_{CM} = V_{CC}$ $V_{CM} = V_{EE}$		200 200	700 700	μV μV
	Input Offset Voltage (LT1367/LT1369)	$V_{CM} = V_{CC}$ $V_{CM} = V_{EE}$		200 200	1000 900	μV μV
ΔV_{OS}	Input Offset Voltage Shift (LT1366/LT1368) Input Offset Voltage Match (Channel to Channel)	$V_{CM} = V_{EE}$ to V_{CC} $V_{CM} = V_{EE}$, V_{CC} (Notes 4, 5)		150 300	500 1300	μV μV
	Input Offset Voltage Shift (LT1367/LT1369) Input Offset Voltage Match (Channel to Channel)	$V_{CM} = V_{EE}$ to V_{CC} $V_{CM} = V_{EE}$, V_{CC} (Notes 4, 5)		150 300	650 2000	μV μV
I_B	Input Bias Current	$V_{CM} = V_{CC}$ $V_{CM} = V_{EE}$	0 -35	10 -10	35 0	nA nA
ΔI_B	Input Bias Current Shift	$V_{CM} = V_{EE}$ to V_{CC}		20	70	nA
I_{OS}	Input Offset Current	$V_{CM} = V_{CC}$ $V_{CM} = V_{EE}$		1.0 0.3	12 12	nA nA
ΔI_{OS}	Input Offset Current Shift	$V_{CM} = V_{EE}$ to V_{CC}		1	12	nA
	Input Bias Current Match (Channel to Channel)	$V_{CM} = V_{CC}$ (Note 4) $V_{CM} = V_{EE}$ (Note 4)	0 0	1 1	12 12	nA nA
C_{IN}	Input Capacitance			7.1		pF
A_{VOL}	Large-Signal Voltage Gain	$V_O = -14.7\text{V}$ to 14.7V , $R_L = 10\text{k}$ $V_O = -10\text{V}$ to 10V , $R_L = 2\text{k}$	1000 500	10000 10000		V/mV V/mV
	Channel Separation	$V_O = -10\text{V}$ to 10V , $R_L = 2\text{k}$	120	135		dB
SR	Slew Rate (LT1366/LT1367)	$A_V = -1$, $R_L = \text{Open}$, $V_O = \pm 10\text{V}$, Measured at $V_O = \pm 5\text{V}$		0.13		V/ μs
	Slew Rate (LT1368/LT1369)	$A_V = -1$, $R_L = \text{Open}$, $V_O = \pm 10\text{V}$, Measured at $V_O = \pm 5\text{V}$		0.065		V/ μs
CMRR	Common Mode Rejection Ratio (LT1366/LT1368) CMRR Match (Channel to Channel)	$V_{CM} = V_{EE}$ to V_{CC} $V_{CM} = V_{EE}$ to V_{CC} (Note 4)	95 89	106 106		dB dB
	Common Mode Rejection Ratio (LT1367/LT1369) CMRR Match (Channel to Channel)	$V_{CM} = V_{EE}$ to V_{CC} $V_{CM} = V_{EE}$ to V_{CC} (Note 4)	93 87	106 106		dB dB
PSRR	Power Supply Rejection Ratio	$V_S = \pm 5\text{V}$ to $\pm 15\text{V}$	90	110		dB
	PSRR Match (Channel to Channel)	$V_S = \pm 5\text{V}$ to $\pm 15\text{V}$ (Note 4)	84	105		dB
V_{OL}	Output Voltage Swing Low	No Load		$V_{EE} + 0.006$	$V_{EE} + 0.012$	V
		$I_{SINK} = 0.5\text{mA}$		$V_{EE} + 0.040$	$V_{EE} + 0.070$	V
		$I_{SINK} = 10\text{mA}$		$V_{EE} + 0.240$	$V_{EE} + 0.500$	V
V_{OH}	Output Voltage Swing High	No Load	$V_{CC} - 0.012$	$V_{CC} - 0.004$		V
		$I_{SINK} = 0.5\text{mA}$	$V_{CC} - 0.100$	$V_{CC} - 0.050$		V
		$I_{SINK} = 2.5\text{mA}$	$V_{CC} - 0.800$	$V_{CC} - 0.400$		V
I_{SC}	Short-Circuit Current	(Note 2)	± 30	± 75		mA
I_S	Supply Current per Amplifier			370	550	μA

ELECTRICAL CHARACTERISTICS The ● denotes the specifications which apply over the specified temperature range of $0^{\circ}\text{C} < T_A < 70^{\circ}\text{C}$. $V_S = \pm 15\text{V}$, $V_{\text{CM}} = 0\text{V}$, $V_O = 0\text{V}$, unless otherwise noted.

SYMBOL	PARAMETER	CONDITIONS		MIN	TYP	MAX	UNITS
V_{OS}	Input Offset Voltage (LT1366/LT1368)	$V_{\text{CM}} = V_{\text{CC}}$ $V_{\text{CM}} = V_{\text{EE}}$	● ●		250 250	850 850	μV μV
	Input Offset Voltage (LT1367/LT1369)	$V_{\text{CM}} = V_{\text{CC}}$ $V_{\text{CM}} = V_{\text{EE}}$	● ●		250 250	1150 1000	μV μV
ΔV_{OS}	Input Offset Voltage Shift (LT1366/LT1368)	$V_{\text{CM}} = V_{\text{EE}}$ to V_{CC}	●		200	525	μV
	Input Offset Voltage Match (Channel to Channel)	$V_{\text{CM}} = V_{\text{EE}}$, V_{CC} (Notes 4, 5)	●		300	1500	μV
ΔV_{OS}	Input Offset Voltage Shift (LT1367/LT1369)	$V_{\text{CM}} = V_{\text{EE}}$ to V_{CC}	●		200	750	μV
	Input Offset Voltage Match (Channel to Channel)	$V_{\text{CM}} = V_{\text{EE}}$, V_{CC} (Notes 4, 5)	●		300	2300	μV
$V_{\text{OS TC}}$	Input Offset Voltage Drift	(Note 3)	●		2	8	$\mu\text{V}/^{\circ}\text{C}$
I_{B}	Input Bias Current	$V_{\text{CM}} = V_{\text{CC}}$	●	0	15	45	nA
		$V_{\text{CM}} = V_{\text{EE}}$	●	-45	-10	0	nA
ΔI_{B}	Input Bias Current Shift	$V_{\text{CM}} = V_{\text{EE}}$ to V_{CC}	●		25	90	nA
I_{OS}	Input Offset Current	$V_{\text{CM}} = V_{\text{CC}}$	●		2	15	nA
		$V_{\text{CM}} = V_{\text{EE}}$	●		1	15	nA
ΔI_{OS}	Input Offset Current Shift	$V_{\text{CM}} = V_{\text{EE}}$ to V_{CC}	●		2	15	nA
	Input Bias Current Match (Channel to Channel)	$V_{\text{CM}} = V_{\text{CC}}$ (Note 4) $V_{\text{CM}} = V_{\text{EE}}$ (Note 4)	● ●	0 0	2 1	15 15	nA nA
A_{VOL}	Large-Signal Voltage Gain	$V_O = -14.7\text{V}$ to 14.7V , $R_L = 10\text{k}$ $V_O = -10\text{V}$ to 10V , $R_L = 2\text{k}$	● ●	750 500	6000 6000		V/mV V/mV
	Channel Separation	$V_O = -10\text{V}$ to 10V , $R_L = 2\text{k}$	●	110	135		dB
CMRR	Common Mode Rejection Ratio (LT1366/LT1368)	$V_{\text{CM}} = V_{\text{EE}}$ to V_{CC}	●	95	103		dB
	CMRR Match (Channel to Channel)	$V_{\text{CM}} = V_{\text{EE}}$ to V_{CC} (Note 4)	●	89	103		dB
PSRR	Power Supply Rejection Ratio	$V_S = \pm 5\text{V}$ to $\pm 15\text{V}$	●	80	105		dB
	PSRR Match (Channel to Channel)	$V_S = \pm 5\text{V}$ to $\pm 15\text{V}$ (Note 4)	●	75	100		dB
V_{OL}	Output Voltage Swing Low	No Load	●		$V_{\text{EE}} + 0.009$	$V_{\text{EE}} + 0.014$	V
		$I_{\text{SINK}} = 0.5\text{mA}$	●		$V_{\text{EE}} + 0.045$	$V_{\text{EE}} + 0.080$	V
		$I_{\text{SINK}} = 10\text{mA}$	●		$V_{\text{EE}} + 0.300$	$V_{\text{EE}} + 0.600$	V
V_{OH}	Output Voltage Swing High	No Load	●	$V_{\text{CC}} - 0.014$	$V_{\text{CC}} - 0.005$		V
		$I_{\text{SOURCE}} = 0.5\text{mA}$	●	$V_{\text{CC}} - 0.11$	$V_{\text{CC}} - 0.055$		V
		$I_{\text{SOURCE}} = 10\text{mA}$	●	$V_{\text{CC}} - 0.95$	$V_{\text{CC}} - 0.500$		V
I_{SC}	Short-Circuit Current	(Note 2)	●	± 30			mA
I_{S}	Supply Current per Amplifier		●		415	575	μA

Note 1: Stresses beyond those listed under Absolute Maximum Ratings may cause permanent damage to the device. Exposure to any Absolute Maximum Rating condition for extended periods may affect device reliability and lifetime.

Note 2: Applies to short circuits to ground for all split supplies and for single supplies less than 20V. Short circuits to either supply for supplies greater than 20V total may permanently damage the part. A heat sink may be required to keep the junction temperature below the absolute maximum rating when the output is shorted indefinitely.

Note 3: This parameter is not 100% tested.

Note 4: Matching parameters are the difference between amplifiers A and D and between B and C on the LT1367/LT1369; between the two amplifiers on the LT1366/LT1368.

Note 5: Input offset voltage match is the difference in offset voltage between amplifiers measured at both $V_{\text{CM}} = V_{\text{EE}}$ and $V_{\text{CM}} = V_{\text{CC}}$.

TYPICAL PERFORMANCE CHARACTERISTICS

(The data presented here applies to the LT1366/LT1367/LT1368/LT1369 unless otherwise noted.)

PNP Stage V_{OS} Distribution (LT1366/LT1368)

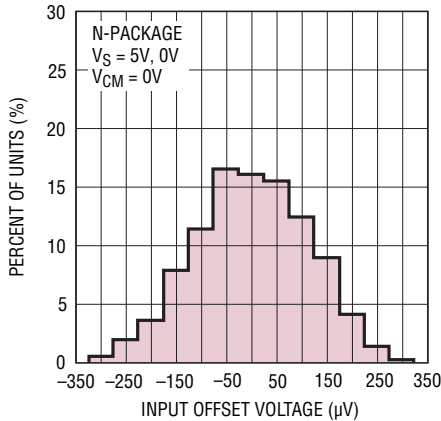

LT1366 TPC03

NPN Stage V_{OS} Distribution (LT1366/LT1368)

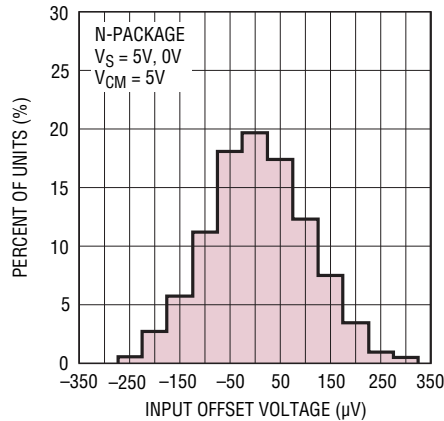

LT1366 TPC02

ΔV_{OS} -Shift Between PNP and NPN Stages (LT1366/LT1368)

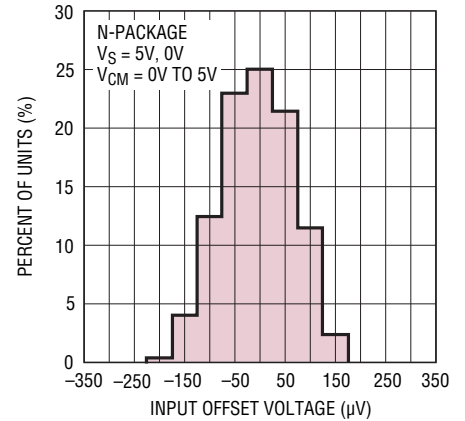

LT1366 TPC01

Supply Current vs Temperature

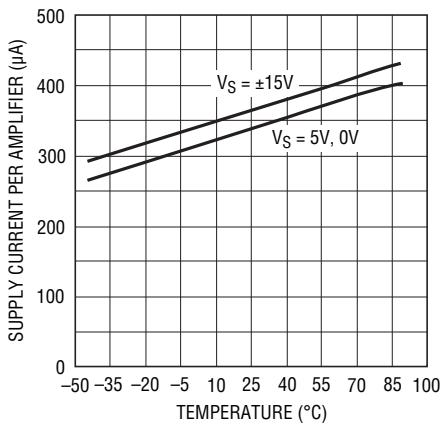

LT1366 TPC04

Supply Current vs Supply Voltage

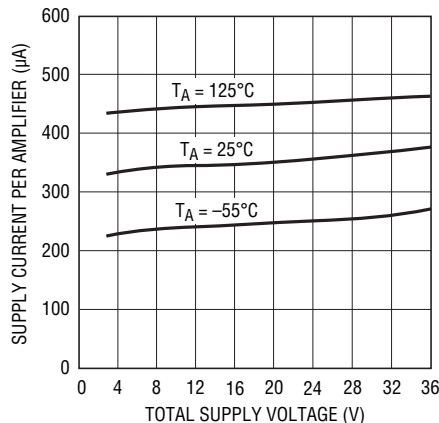

LT1366 TPC05

Input Bias Current vs Common Mode Voltage

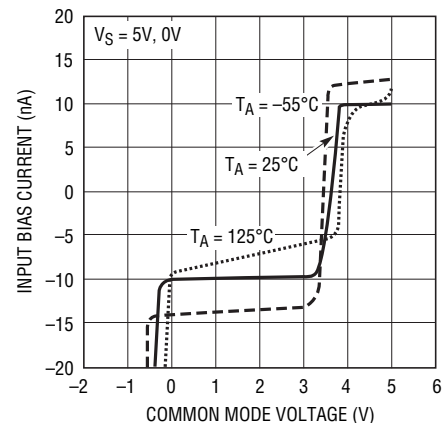

LT1366 TPC06

Input Bias Current vs Temperature

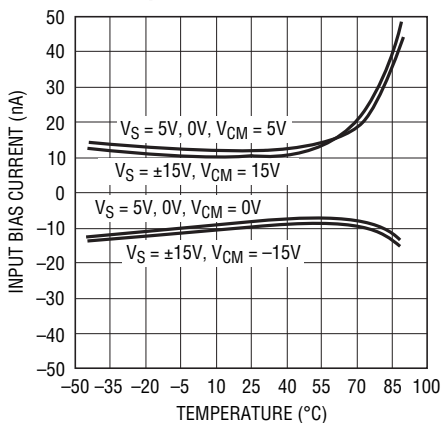

LT1366 TPC07

Output Saturation Voltage vs Load Current (Output High)

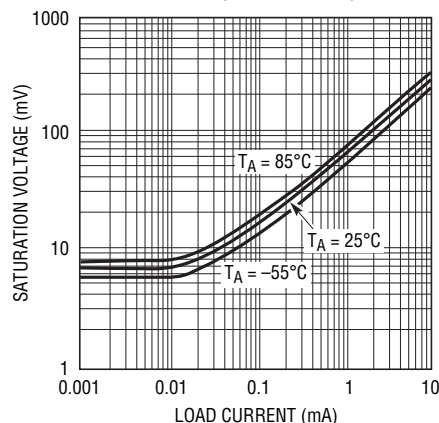

LT1366 TPC08

Output Saturation Voltage vs Load Current (Output Low)

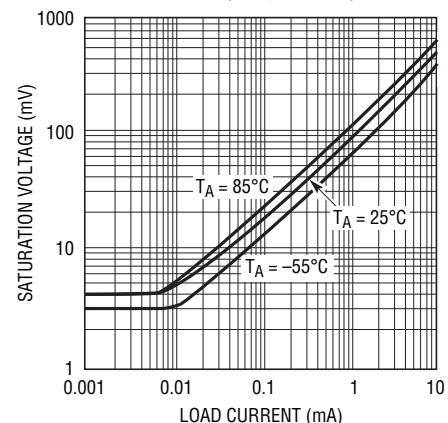

LT1366 TPC09

TYPICAL PERFORMANCE CHARACTERISTICS

(The data presented here applies to the LT1366/LT1367/LT1368/LT1369 unless otherwise noted.)

Minimum Supply Voltage

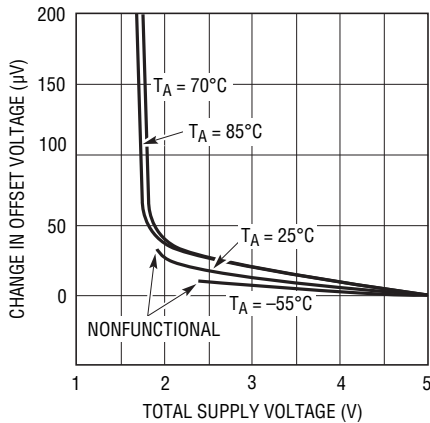

LT1366 TPC10

0.1Hz to 10Hz Output Voltage Noise

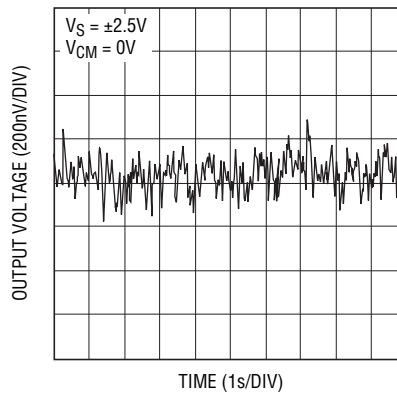

LT1366 TPC11

Noise Voltage Spectrum

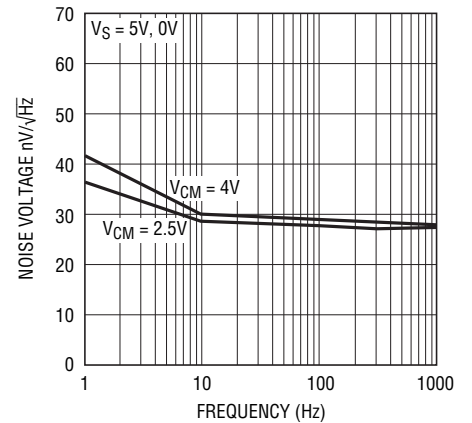

LT1366 TPC12

Noise Current Spectrum

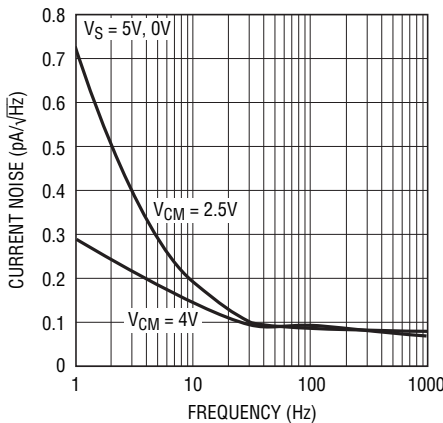

LT1366 TPC13

Gain and Phase Shift vs Frequency (LT1366/LT1367)

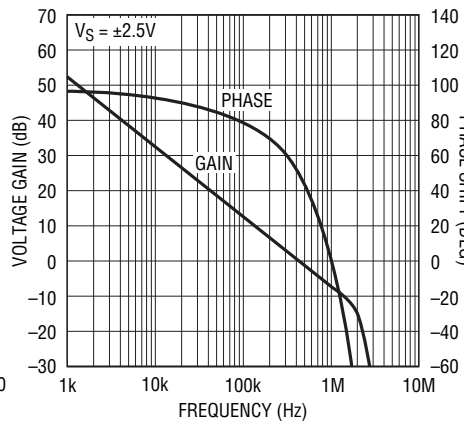

LT1366 TPC14

Gain and Phase Shift vs Frequency (LT1368/LT1369)

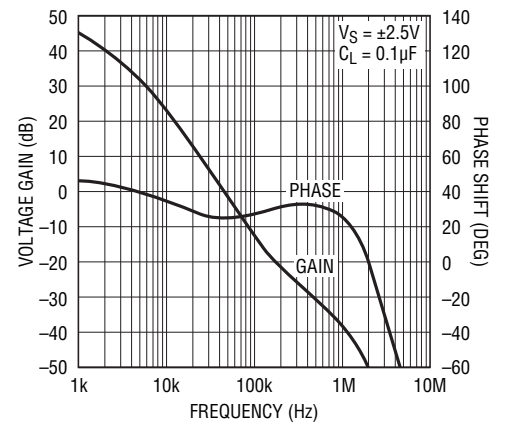

LT1366 TPC15

CMRR vs Frequency (LT1366 and LT1367)

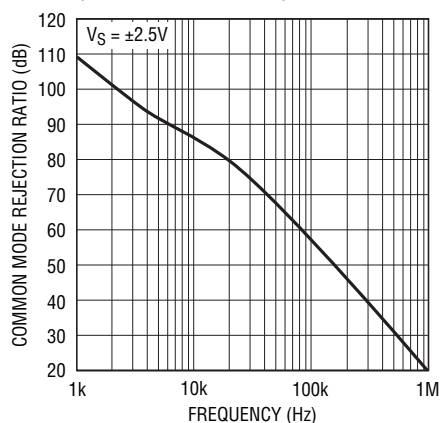

LT1366 TPC16

PSRR vs Frequency (LT1366/LT1367)

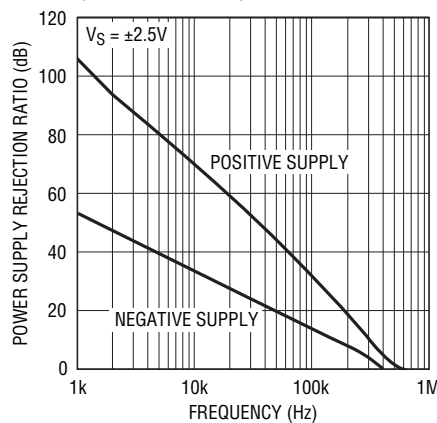

LT1366 TPC17

PSRR vs Frequency (LT1368/LT1369)

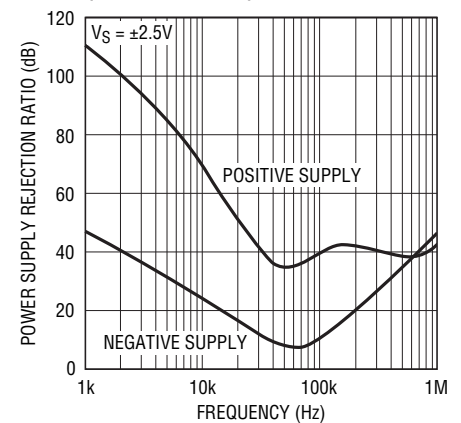

LT1366 TPC18

TYPICAL PERFORMANCE CHARACTERISTICS

(The data presented here applies to the LT1366/LT1367/LT1368/LT1369 unless otherwise noted.)

Gain-Bandwidth and Phase Margin vs Supply Voltage (LT1366/LT1367)

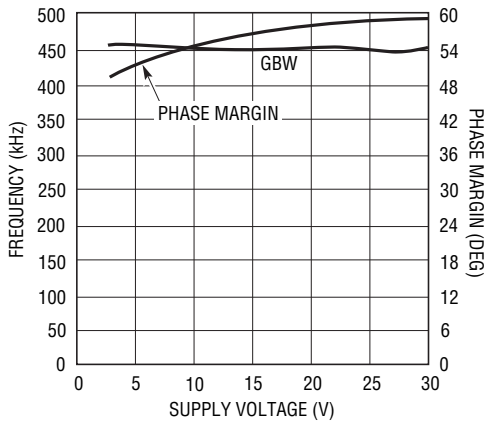

LT1366 TPC19

Channel Separation vs Frequency

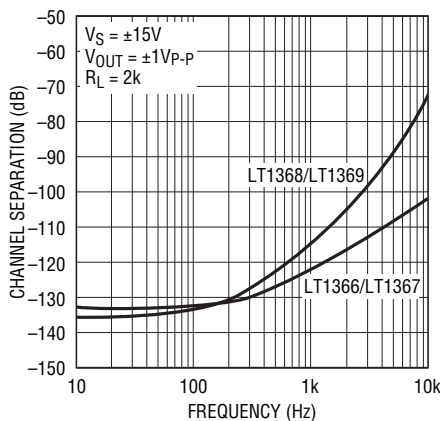

LT1366 TPC20

Open-Loop Gain

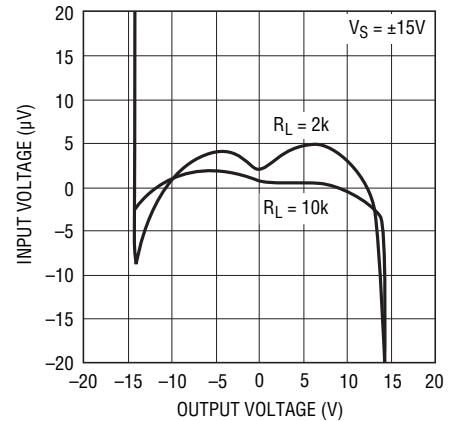

LT1366 TPC21

Capacitive Load Handling (LT1366/LT1367)

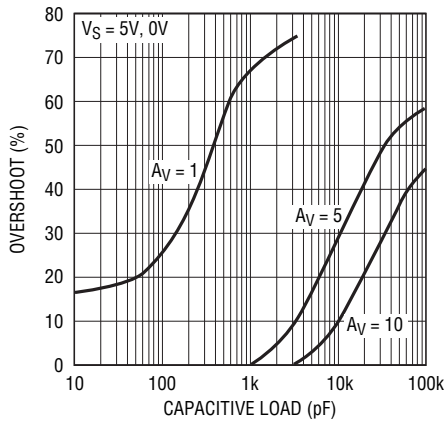

LT1366 TPC22

Overshoot vs Load Current (LT1368/LT1369)

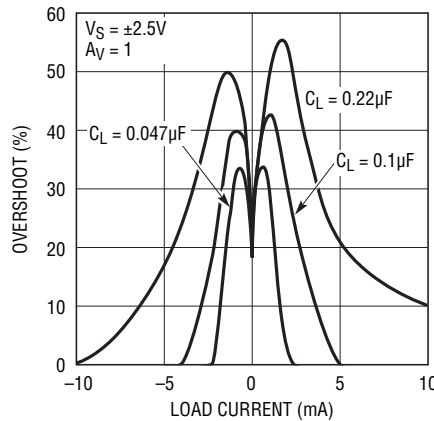

LT1366 TPC23

Overshoot vs Load Current (LT1368/LT1369)

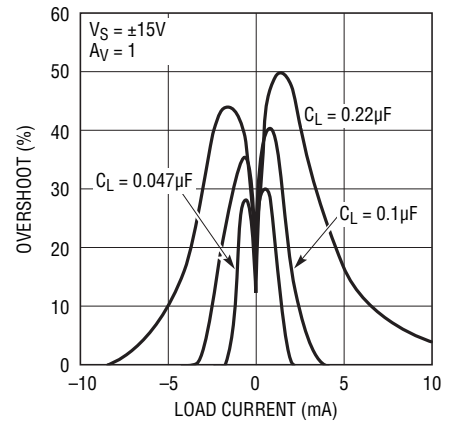

LT1366 TPC24

Slew Rate vs Supply Voltage

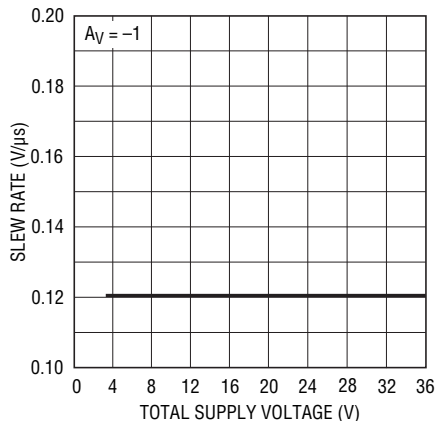

LT1366 TPC25

Warm-Up Drift vs Time

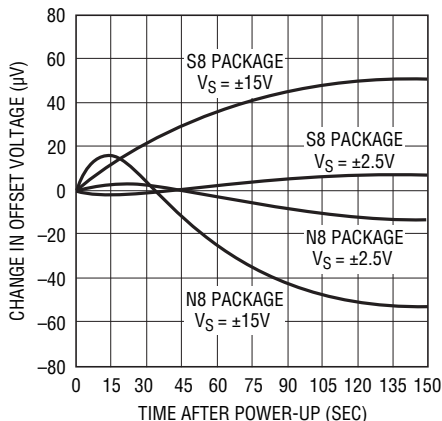

LT1366 TPC26

THD + Noise vs Peak-to-Peak Voltage

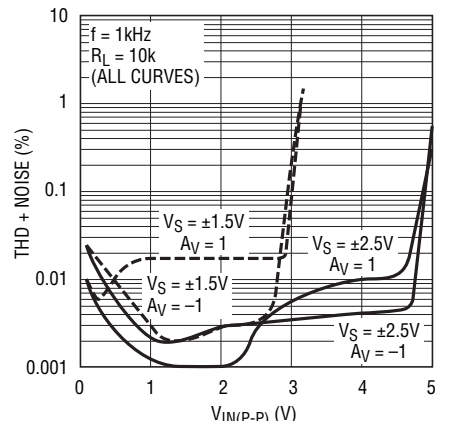

LT1366 TPC27

TYPICAL PERFORMANCE CHARACTERISTICS

(The data presented here applies to the LT1366/LT1367/LT1368/LT1369 unless otherwise noted.)

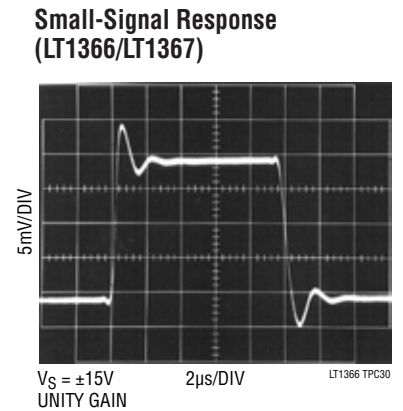
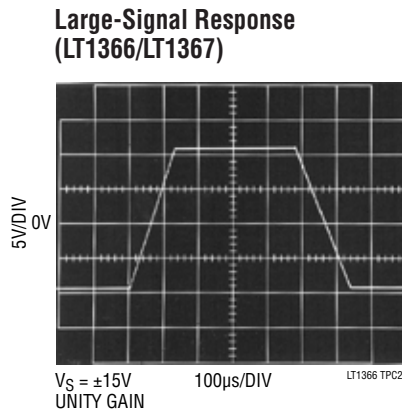
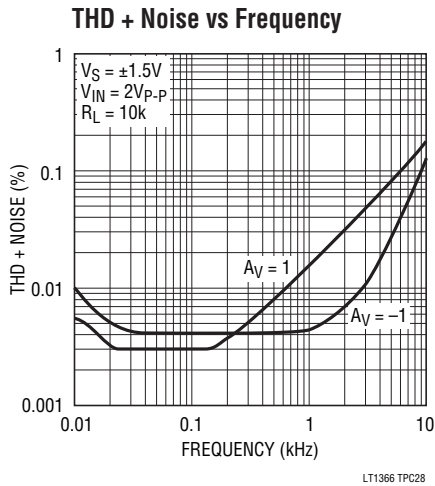

APPLICATIONS INFORMATION

Rail-to-Rail Operation

The LT1366 family differs from conventional op amps in the design of both the input and output stages. Figure 1 shows a simplified schematic of the amplifier. The input stage consists of two differential amplifiers, a PNP stage Q1/Q2 and an NPN stage Q3/Q4, which are active over different

portions of the input common mode range. Lateral devices are used in both input stages, eliminating the need for clamps across the input pins. Each input stage is trimmed for offset voltage. A complementary output configuration (Q23 through Q26) is employed to create an output stage with rail-to-rail swing. The amplifier is fabricated on Linear

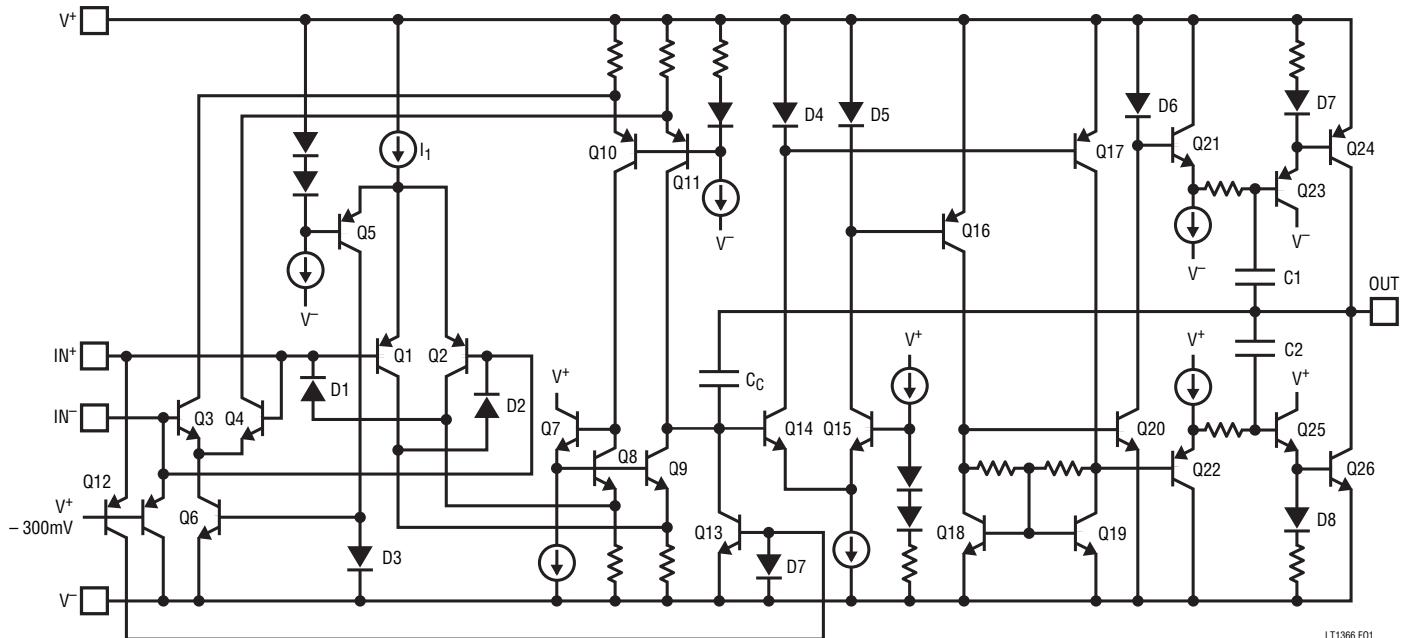

Figure 1. LT1366 Simplified Schematic Diagram

APPLICATIONS INFORMATION

Technology's proprietary complementary bipolar process, which ensures very similar DC and AC characteristics for the output devices Q24 and Q26.

A simple comparator Q5 steers current from current source I_1 between the two input stages. When the input common mode voltage V_{CM} is near the negative supply, Q5 is reverse biased, and I_1 becomes the tail current for the PNP differential pair Q1/Q2. At the other extreme, when V_{CM} is within about 1.3V from the positive supply, Q5 diverts I_1 to the current mirror D3/Q6, which furnishes the tail current for the NPN differential pair Q3/Q4.

The collector currents of the two input pairs are combined in the second stage, consisting of Q7 through Q11. Most of the voltage gain in the amplifier is contained in this stage. Differential amplifier Q14/Q15 buffers the output of the second stage, converting the output voltage to differential currents. The differential currents pass through current mirrors D4/Q17 and D5/Q16, and are converted to differential voltages by Q18 and Q19. These voltages are also buffered and applied to the output Darlington pairs Q23/Q24 and Q25/Q26. Capacitors C1 and C2 form local feedback loops around the output devices, lowering the output impedance at high frequencies.

Input Offset Voltage

Since the amplifier has two input stages, the input offset voltage changes depending upon which stage is active. The input offsets are random, but bounded voltages. When the amplifier switches between stages, offset voltages may go up, down, or remain flat; but will not exceed the guaranteed limits. This behavior is illustrated in three distribution plots of input offset voltage in the Typical Performance Characteristics section.

Overdrive Protection

Two circuits prevent the output from reversing polarity when the input voltage exceeds the common mode range. When the noninverting input exceeds the positive supply by approximately 300mV, the clamp transistor Q12 (Figure 1) turns on, pulling the output of the second stage low, which forces the output high. For inputs below the negative supply, diodes D1 and D2 turn on, overcoming the saturation of the input pair Q1/Q2.

When overdriven, the amplifier draws input current that exceeds the normal input bias current. Figures 2 and 3 show some typical overdrive currents as a function of input voltage. The input current must be less than 1mA of positive overdrive or less than 7mA of negative overdrive, for the phase reversal protection to work properly. When the amplifier is severely overdriven, an external resistor should be used to limit the overdrive current. In addition to overdrive protection, the amplifier is protected against ESD strokes up to 4kV on all pins.

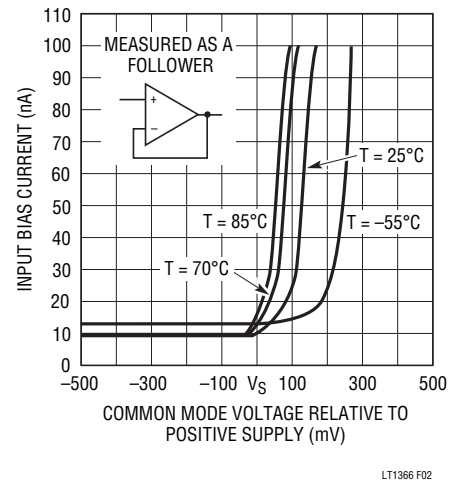

Figure 2. Input Bias Current vs Common Mode Voltage

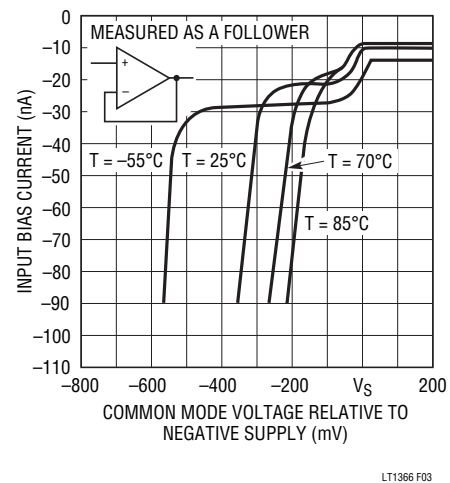

Figure 3. Input Bias Current vs Common Mode Voltage

APPLICATIONS INFORMATION

Improved Supply Rejection in the LT1368/LT1369

The LT1368/LT1369 are variations of the LT1366/LT1367 offering greater supply rejection and lower high frequency output impedance. The LT1368/LT1369 require a 0.1 μ F load capacitance for compensation. The output capacitance forms a filter, which reduces pickup from the supply and lowers the output impedance. This additional filtering is helpful in mixed analog/digital systems with common supplies, or systems employing switching supplies. Filtering also reduces high frequency noise, which may be beneficial when driving A/D converters.

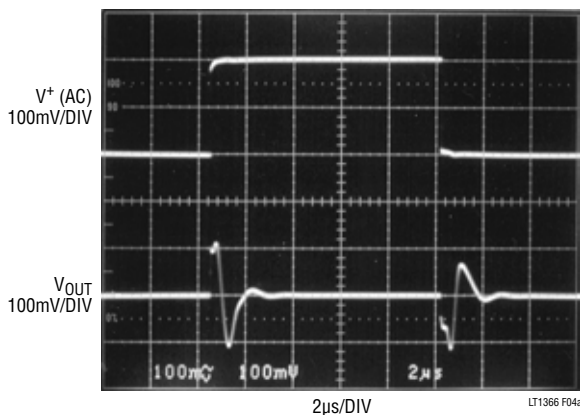

Figure 4a. LT1366 Power Supply Rejection Test

Figure 4 shows the outputs of the LT1366/LT1368 perturbed by a 200mV_{P-P} 50kHz square wave added to the positive supply. The LT1368's power supply rejection is about ten times greater than that of the LT1366 at 50kHz. Note the 5-to-1 scale change in the output voltage traces.

The tolerance of the external compensation capacitor is not critical. The plots of Overshoot vs Load Current in the Typical Performance Characteristics section illustrate the effect of a capacitive load.

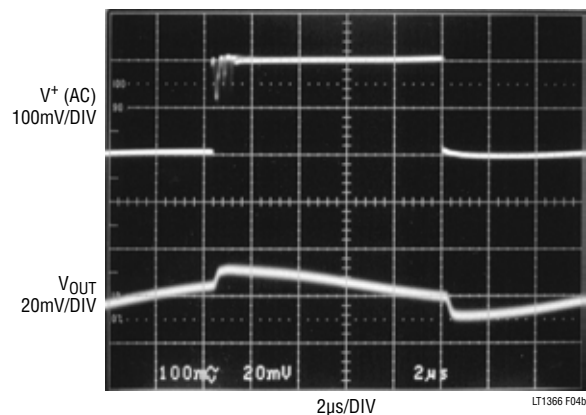

Figure 4b. LT1368 Power Supply Rejection Test

TYPICAL APPLICATIONS

Buffering A/D Converters

Figure 5 shows the LT1368 driving an LTC[®]1288 2-channel micropower A/D converter (ADC). The LTC1288 can accommodate voltage references and input signals equal to the supply rails. The sampling nature of this ADC eliminates the need for an external sample-and-hold, but may call for a drive amplifier because of the ADC's 12 μ s settling requirement. The LT1368's rail-to-rail operation and low input offset voltage make it well-suited for low power, low frequency A/D applications. Either the LT1366 or LT1368 could be used for this application. However, for low frequencies ($f < 1$ kHz) the LT1368 provides better supply rejection.

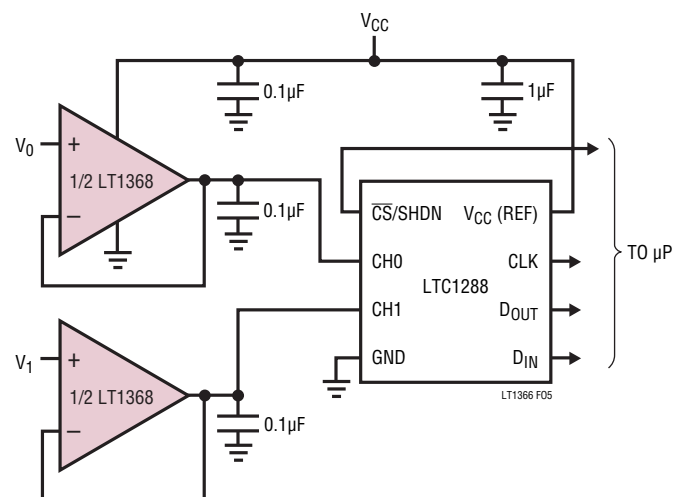

Figure 5. 2-Channel Low Power A/D Converter

TYPICAL APPLICATIONS

High Side Current Source

The wide compliance current source shown in Figure 7 takes advantage of the LT1366's ability to measure small signals near the positive supply rail. The LT1366 adjusts Q1's gate voltage to force the voltage across the sense resistor (R_{SENSE}) to equal the voltage from the supply to the potentiometer's wiper. A rail-to-rail op amp is needed because the voltage across the sense resistor must drop to zero when the divided reference voltage is set to zero. Q2 acts as a constant current sink to minimize error in the reference voltage when the supply voltage varies.

The circuit can operate over a wide supply range ($5V < V_{CC} < 30V$). At low input voltage, circuit operation is limited by the MOSFET's gate drive requirements. At

high input voltage, circuit operation is limited by the LT1366's absolute maximum ratings and the output power requirements.

The circuit delivers 1A at 200mV of sense voltage. With a 5V input supply, the power dissipation is 5W. For operation at 70°C ambient temperature, the MOSFET's heat sink must have a thermal resistance of:

$$\begin{aligned}\theta_{HS} &= \theta_{JA}(\text{SYSTEM}) - \theta_{JC}(\text{FET}) \\ &= (125^{\circ}\text{C} - 70^{\circ}\text{C})/5\text{W} - 1.25^{\circ}\text{C}/\text{W} \\ &= 11^{\circ}\text{C}/\text{W} - 1.25^{\circ}\text{C}/\text{W} \\ &= 9.75^{\circ}\text{C}/\text{W}\end{aligned}$$

which is easily achievable with a small heat sink. Input voltages greater than 5V require the use of a larger heat sink or a reduction of the output current.

The circuit's supply regulation is about 0.03%/V. The output impedance is equal to the MOSFET's output impedance multiplied by the op amp's open-loop gain. Degradations in current-source compliance occur when the voltage across the MOSFET's on-resistance and the sense resistor drops below the voltage required to maintain the desired output current. This condition occurs when:

$$[V_{CC} - V_{OUT}] < [I_{LOAD} \cdot (R_{SENSE} + R_{ON})]$$

Single Supply, 1kHz, 4th Order Butterworth Filter

An LT1367 is used in Figure 8 to form a 4th order Butterworth filter. The filter is a simplified state variable architecture consisting of two cascaded 2nd order sections. Each section uses the 360 degree phase shift around

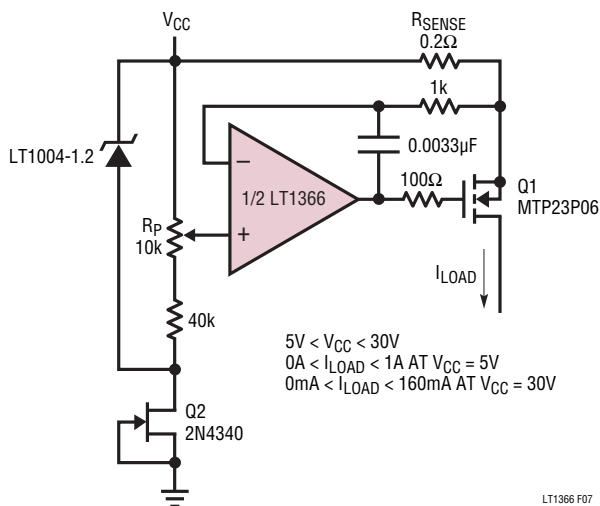

Figure 7. High Side Current Source

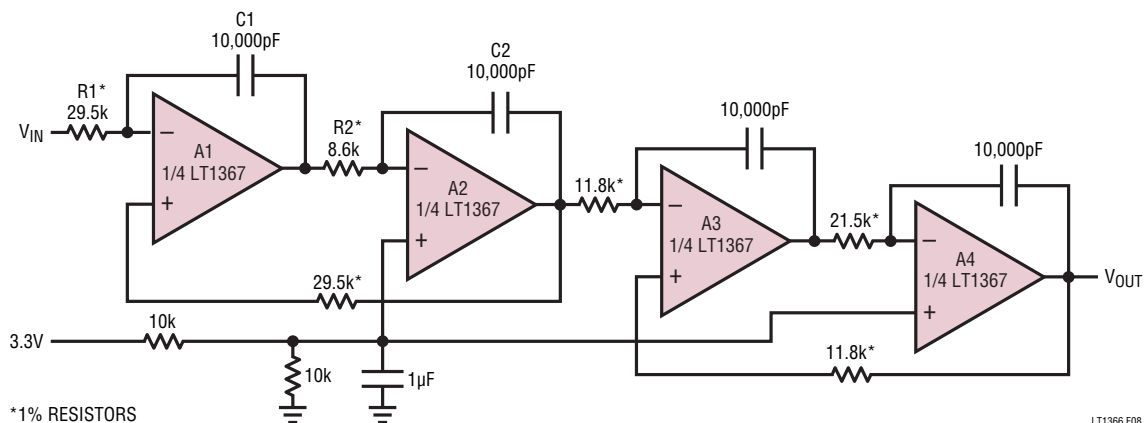

Figure 8. 4-Pole 1kHz, 3.3V Single Supply, State Variable Filter Using the LT1367

TYPICAL APPLICATIONS

the 2 op amp loop to create a negative summing junction at A1's positive input¹. The circuit has low sensitivities for center frequency and Q, which are set with the following equations:

$$\omega_0^2 = 1/(R1 \cdot C1 \cdot R2 \cdot C2)$$

where:

$$R1 = 1/(\omega_0 \cdot Q \cdot C1) \text{ and } R2 = Q/(\omega_0 \cdot C2).$$

The DC bias applied to A2 and A4, half supply, is not needed when split supplies are available. The circuit swings rail-to-rail in the passband making it an excellent anti-aliasing filter for ADCs. The amplitude response is flat to 1kHz then rolls off at 80dB/decade.

¹James Hahn, "State Variable Filter Trims Predecessor's Component Count," Electronics, April 21, 1982.

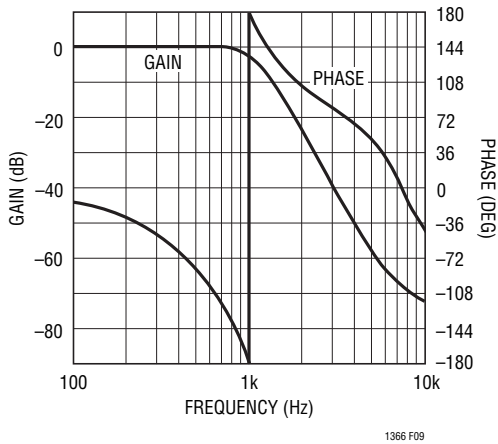

Figure 9. Frequency Response of 4th Order Butterworth Filter

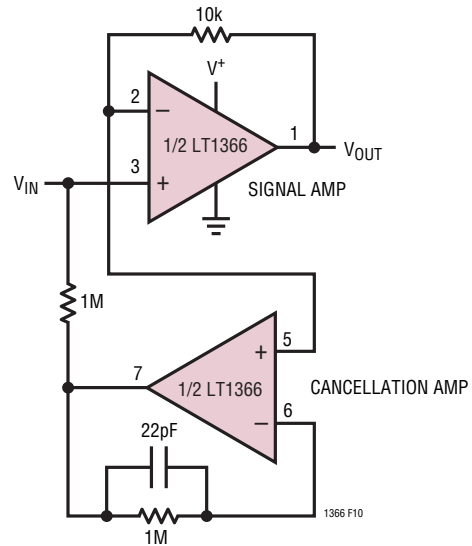

Figure 10. Input Bias Current Cancellation

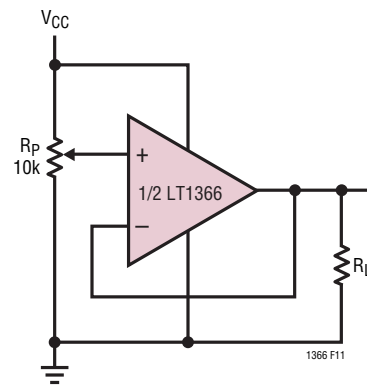
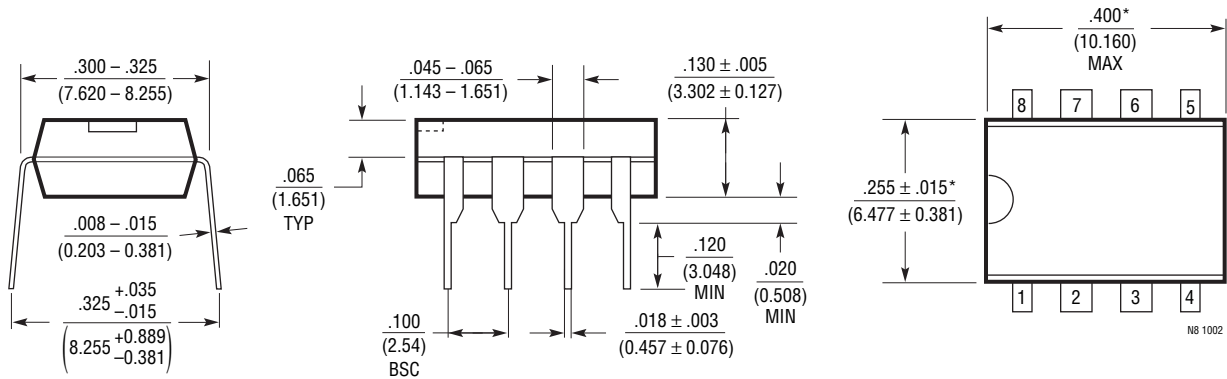

Figure 11. Rail-to-Rail Potentiometer Buffer

PACKAGE DESCRIPTION

N8 Package 8-Lead PDIP (Narrow .300 Inch) (Reference LTC DWG # 05-08-1510)



NOTE:

1. DIMENSIONS ARE $\frac{\text{INCHES}}{\text{MILLIMETERS}}$

*THESE DIMENSIONS DO NOT INCLUDE MOLD FLASH OR PROTRUSIONS.
MOLD FLASH OR PROTRUSIONS SHALL NOT EXCEED .010 INCH (0.254mm)

S8 Package 8-Lead Plastic Small Outline (Narrow .150 Inch) (Reference LTC DWG # 05-08-1610)

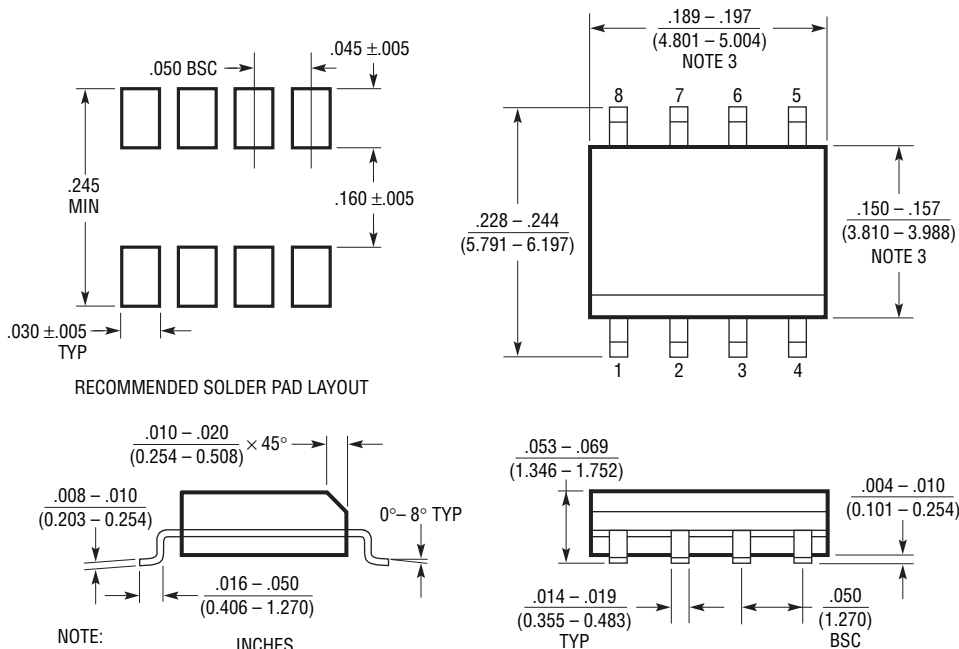

NOTE:

1. DIMENSIONS IN $\frac{\text{INCHES}}{\text{MILLIMETERS}}$

2. DRAWING NOT TO SCALE

3. THESE DIMENSIONS DO NOT INCLUDE MOLD FLASH OR PROTRUSIONS.
MOLD FLASH OR PROTRUSIONS SHALL NOT EXCEED .006" (0.15mm)

S08 0303

PACKAGE DESCRIPTION

S Package
14-Lead Plastic Small Outline (Narrow .150 Inch)
 (Reference LTC DWG # 05-08-1610)

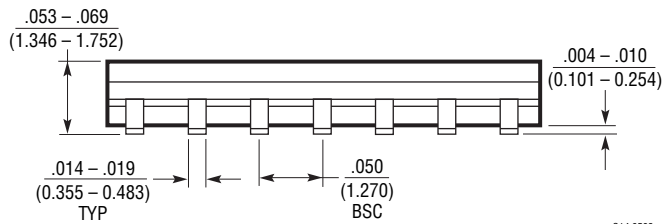
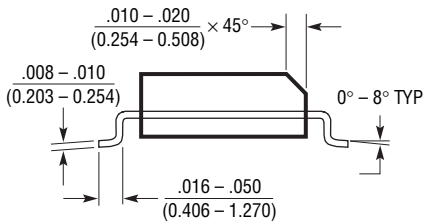
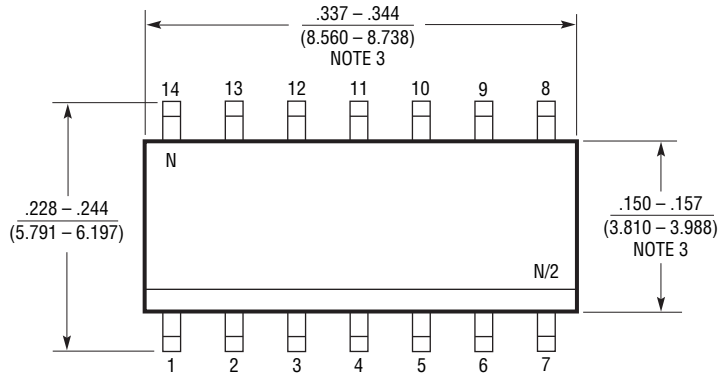
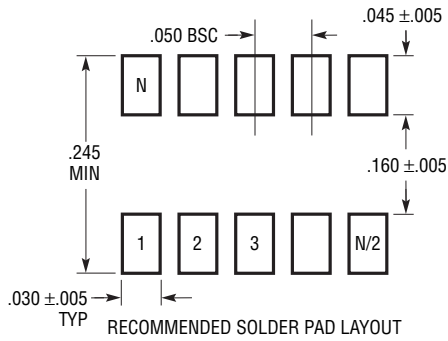

- NOTE:
 1. DIMENSIONS IN $\frac{\text{INCHES}}{\text{MILLIMETERS}}$
 2. DRAWING NOT TO SCALE
 3. THESE DIMENSIONS DO NOT INCLUDE MOLD FLASH OR PROTRUSIONS.
 MOLD FLASH OR PROTRUSIONS SHALL NOT EXCEED .006" (0.15mm)

S14 0502

REVISION HISTORY (Revision history begins at Rev B)

REV	DATE	DESCRIPTION	PAGE NUMBER
B	03/10	Change to Absolute Maximum Ratings	2
		Updated Format of Order Information Section	2
		Change to Electrical Characteristics Note	3, 4, 5, 6, 7

TYPICAL APPLICATION

Instrumentation Amplifier

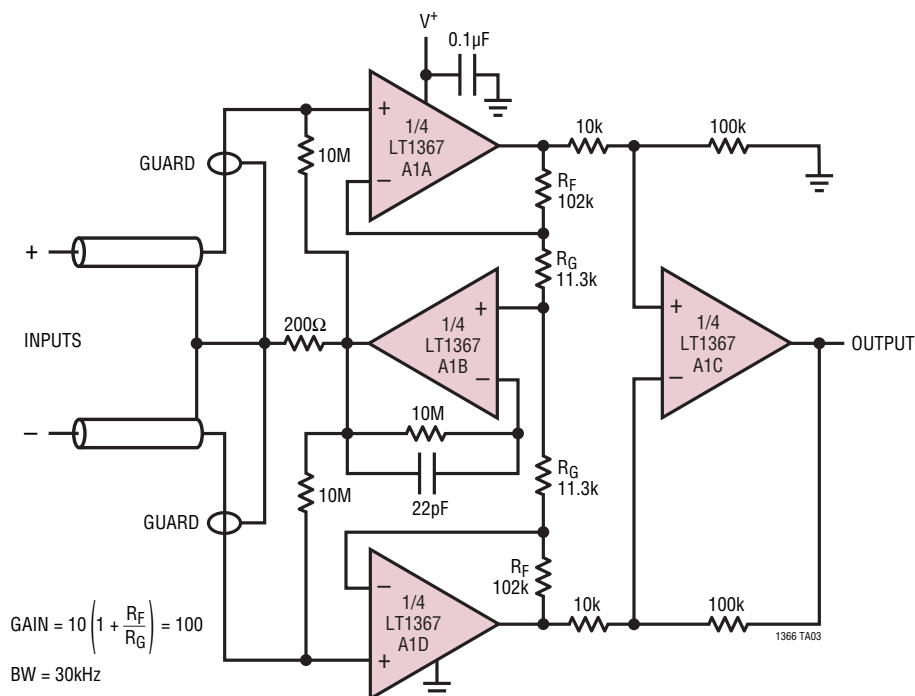

RELATED PARTS

PART	DESCRIPTION	COMMENTS
LT1078/LT1079	Dual/Quad 55µA Max, Single Supply, Precision Op Amps	Input/Output Common Mode Includes Ground, 70µV V _{OS(MAX)} and 2.5µV/°C Drift (Max), 200kHz GBW, 0.07V/µs Slew Rate
LTC1152	Rail-to-Rail Input, Rail-to-Rail Output, Zero-Drift Amplifier	High DC Accuracy, 10µV V _{OS(MAX)} , 100nV/°C Drift, 1MHz GBW, 1V/µs Slew Rate, Supply Current 2.2mA (Max), Single Supply, Can Be Configured for C-Load™ Operation
LT1178/LT1179	Dual/Quad 17µA Max, Single Supply, Precision Op Amps	Input/Output Common Mode Includes Ground, 70µV V _{OS(MAX)} and 4µV/°C Drift (Max), 85kHz GBW, 0.04V/µs Slew Rate
LT1211/LT1212	Dual/Quad 14MHz, 7V/µs, Single Supply, Precision Op Amps	Input Common Mode Includes Ground, 275µV V _{OS(MAX)} and 6µV/°C Drift (Max), Supply Current 1.8mA per Op Amp (Max)
LT1495/LT1496	1.5µA, Rail-to-Rail Input/Output Dual/Quad	375µV V _{OS(MAX)} , 2µV/°C Drift (Max), Over-The-Top® Input