

Product specifications

| Part Number | Rated Inductance (μH) | Parallel Ratings           |                                   |  |                         |                         | Series Ratings             |                                   |  |                         |                         |
|-------------|-----------------------|----------------------------|-----------------------------------|--|-------------------------|-------------------------|----------------------------|-----------------------------------|--|-------------------------|-------------------------|
|             |                       | OCL <sup>1</sup> ±20% (μH) | I <sub>rms</sub> <sup>2</sup> (A) | I <sub>sat</sub> <sup>3</sup> (A) Peak | DCR Ω <sup>4</sup> typ. | Volt <sup>5</sup> μ-sec | OCL <sup>1</sup> ±20% (μH) | I <sub>rms</sub> <sup>2</sup> (A) | I <sub>sat</sub> <sup>3</sup> (A) Peak | DCR Ω <sup>4</sup> typ. | Volt <sup>5</sup> μ-sec |
| DRQ73-R33-R | 0.33                  | 0.306                      | 6.19                              | 14.4                                   | 0.0074                  | 1.98                    | 1.224                      | 3.10                              | 7.18                                   | 0.0296                  | 3.96                    |
| DRQ73-1R0-R | 1.00                  | 0.992                      | 5.25                              | 7.97                                   | 0.0103                  | 3.56                    | 3.968                      | 2.63                              | 3.99                                   | 0.0411                  | 7.12                    |
| DRQ73-1R5-R | 1.50                  | 1.482                      | 4.64                              | 6.52                                   | 0.0132                  | 4.36                    | 5.928                      | 2.32                              | 3.26                                   | 0.0527                  | 8.72                    |
| DRQ73-2R2-R | 2.20                  | 2.070                      | 4.11                              | 5.52                                   | 0.0167                  | 5.15                    | 8.280                      | 2.06                              | 2.76                                   | 0.0669                  | 10.3                    |
| DRQ73-3R3-R | 3.30                  | 3.540                      | 3.31                              | 4.22                                   | 0.0259                  | 6.73                    | 14.16                      | 1.66                              | 2.11                                   | 0.1035                  | 13.5                    |
| DRQ73-4R7-R | 4.70                  | 4.422                      | 3.09                              | 3.78                                   | 0.0297                  | 7.52                    | 17.69                      | 1.55                              | 1.89                                   | 0.1188                  | 15.0                    |
| DRQ73-6R8-R | 6.80                  | 6.480                      | 2.55                              | 3.12                                   | 0.0435                  | 9.11                    | 25.92                      | 1.28                              | 1.56                                   | 0.1742                  | 18.2                    |
| DRQ73-8R2-R | 8.20                  | 8.930                      | 2.19                              | 2.66                                   | 0.0592                  | 10.7                    | 35.72                      | 1.10                              | 1.33                                   | 0.2368                  | 21.4                    |
| DRQ73-100-R | 10.0                  | 10.30                      | 2.08                              | 2.47                                   | 0.0656                  | 11.5                    | 41.20                      | 1.04                              | 1.24                                   | 0.2623                  | 23.0                    |
| DRQ73-150-R | 15.0                  | 15.01                      | 1.83                              | 2.05                                   | 0.0844                  | 13.9                    | 60.04                      | 0.916                             | 1.03                                   | 0.339                   | 27.8                    |
| DRQ73-220-R | 22.0                  | 22.65                      | 1.62                              | 1.67                                   | 0.107                   | 17.0                    | 90.60                      | 0.811                             | 0.83                                   | 0.429                   | 34.0                    |
| DRQ73-330-R | 33.0                  | 34.41                      | 1.31                              | 1.35                                   | 0.166                   | 21.0                    | 137.6                      | 0.653                             | 0.68                                   | 0.665                   | 42.0                    |
| DRQ73-470-R | 47.0                  | 48.62                      | 1.08                              | 1.14                                   | 0.241                   | 24.9                    | 194.5                      | 0.542                             | 0.57                                   | 0.965                   | 49.8                    |
| DRQ73-680-R | 68.0                  | 68.91                      | 0.89                              | 0.96                                   | 0.358                   | 29.7                    | 275.6                      | 0.444                             | 0.48                                   | 1.43                    | 59.4                    |
| DRQ73-820-R | 82.0                  | 80.37                      | 0.86                              | 0.89                                   | 0.384                   | 32.1                    | 321.5                      | 0.430                             | 0.44                                   | 1.54                    | 64.2                    |
| DRQ73-101-R | 100                   | 101.4                      | 0.73                              | 0.79                                   | 0.527                   | 36.0                    | 405.6                      | 0.367                             | 0.39                                   | 2.11                    | 72.0                    |
| DRQ73-151-R | 150                   | 150.9                      | 0.58                              | 0.65                                   | 0.851                   | 44.0                    | 603.6                      | 0.289                             | 0.32                                   | 3.41                    | 88.0                    |
| DRQ73-221-R | 220                   | 223.3                      | 0.52                              | 0.53                                   | 1.05                    | 53.5                    | 893.2                      | 0.260                             | 0.27                                   | 4.20                    | 107                     |
| DRQ73-331-R | 330                   | 325.5                      | 0.42                              | 0.44                                   | 1.59                    | 64.5                    | 1302                       | 0.211                             | 0.22                                   | 6.36                    | 129                     |
| DRQ73-471-R | 470                   | 465.8                      | 0.35                              | 0.37                                   | 2.36                    | 77.2                    | 1863                       | 0.173                             | 0.18                                   | 9.44                    | 154                     |
| DRQ73-681-R | 680                   | 676.5                      | 0.29                              | 0.31                                   | 3.47                    | 93.1                    | 2706                       | 0.143                             | 0.15                                   | 13.88                   | 186                     |
| DRQ73-821-R | 820                   | 821.7                      | 0.27                              | 0.28                                   | 3.93                    | 103                     | 3287                       | 0.134                             | 0.14                                   | 15.72                   | 206                     |
| DRQ73-102-R | 1000                  | 995.0                      | 0.26                              | 0.25                                   | 4.34                    | 113                     | 3980                       | 0.128                             | 0.13                                   | 17.36                   | 226                     |

1. Open Circuit Inductance Test Parameters: 100 kHz, 0.25 V<sub>rms</sub>, 0.0 Adc  
Parallel: (1,2 -4,3) Series: (1-4) tie (2-3)
2. RMS current for an approximate DT of 40 °C without core loss.  
It is recommended that the temperature of the part not exceed +125 °C.
3. Peak current for approximately 30% roll-off at +20 °C
4. DCR limits @ +20 °C
5. Applied Volt-Time product (V-μs) across the inductor. This value represents the applied V-μs at 100 kHz necessary to generate a core loss equal to 10% of the total losses for a 40 °C temperature rise.

6. Turns Ratio (1:3):(2-4) 1:1
7. Part number definition: DRQxxx-yyy-  
- DRQxxx = product code and size,  
- yyy = inductance value in μH,  
- R = decimal point. If no R is present, third character = # of zeros  
- "-R" suffix = RoHS compliant

Product specifications

| Part Number | Rated Inductance (μH) | Parallel Ratings           |                                   |  |                         |                         | Series Ratings             |                                   |  |                         |                         |
|-------------|-----------------------|----------------------------|-----------------------------------|--|-------------------------|-------------------------|----------------------------|-----------------------------------|--|-------------------------|-------------------------|
|             |                       | OCL <sup>1</sup> ±20% (μH) | I <sub>rms</sub> <sup>2</sup> (A) | I <sub>sat</sub> <sup>3</sup> (A) Peak | DCR Ω <sup>4</sup> Typ. | Volt <sup>5</sup> μ-sec | OCL <sup>1</sup> ±20% (μH) | I <sub>rms</sub> <sup>2</sup> (A) | I <sub>sat</sub> <sup>3</sup> (A) Peak | DCR Ω <sup>4</sup> Typ. | Volt <sup>5</sup> μ-sec |
| DRQ74-R33-R | 0.33                  | 0.294                      | 6.20                              | 18.4                                   | 0.0074                  | 1.71                    | 1.176                      | 3.10                              | 9.18                                   | 0.0295                  | 3.42                    |
| DRQ74-1R0-R | 1.00                  | 0.952                      | 5.33                              | 10.2                                   | 0.0100                  | 3.08                    | 3.808                      | 2.66                              | 5.10                                   | 0.0400                  | 6.16                    |
| DRQ74-1R5-R | 1.50                  | 1.422                      | 4.96                              | 8.35                                   | 0.0115                  | 3.76                    | 5.688                      | 2.48                              | 4.17                                   | 0.0461                  | 7.52                    |
| DRQ74-2R2-R | 2.20                  | 1.986                      | 4.66                              | 7.06                                   | 0.0130                  | 4.45                    | 7.944                      | 2.33                              | 3.53                                   | 0.0521                  | 8.9                     |
| DRQ74-3R3-R | 3.30                  | 3.396                      | 3.94                              | 5.40                                   | 0.0183                  | 5.81                    | 13.58                      | 1.97                              | 2.70                                   | 0.0732                  | 11.6                    |
| DRQ74-4R7-R | 4.70                  | 5.182                      | 3.34                              | 4.37                                   | 0.0254                  | 7.18                    | 20.73                      | 1.67                              | 2.19                                   | 0.102                   | 14.4                    |
| DRQ74-6R8-R | 6.80                  | 7.344                      | 2.60                              | 3.67                                   | 0.0418                  | 8.55                    | 29.38                      | 1.30                              | 1.84                                   | 0.167                   | 17.1                    |
| DRQ74-8R2-R | 8.20                  | 8.566                      | 2.53                              | 3.40                                   | 0.0441                  | 9.23                    | 34.26                      | 1.27                              | 1.70                                   | 0.177                   | 18.5                    |
| DRQ74-100-R | 10.0                  | 9.882                      | 2.41                              | 3.17                                   | 0.0489                  | 9.92                    | 39.53                      | 1.20                              | 1.58                                   | 0.196                   | 19.8                    |
| DRQ74-150-R | 15.0                  | 16.09                      | 2.11                              | 2.48                                   | 0.0637                  | 12.7                    | 64.36                      | 1.05                              | 1.24                                   | 0.255                   | 25.4                    |
| DRQ74-220-R | 22.0                  | 21.73                      | 1.75                              | 2.13                                   | 0.0925                  | 14.7                    | 86.92                      | 0.874                             | 1.07                                   | 0.371                   | 29.4                    |
| DRQ74-330-R | 33.0                  | 33.01                      | 1.41                              | 1.73                                   | 0.143                   | 18.1                    | 132.0                      | 0.702                             | 0.87                                   | 0.574                   | 36.2                    |
| DRQ74-470-R | 47.0                  | 49.64                      | 1.15                              | 1.41                                   | 0.216                   | 22.2                    | 198.6                      | 0.573                             | 0.71                                   | 0.865                   | 44.4                    |
| DRQ74-680-R | 68.0                  | 69.67                      | 1.03                              | 1.19                                   | 0.265                   | 26.3                    | 278.7                      | 0.517                             | 0.60                                   | 1.06                    | 52.6                    |
| DRQ74-820-R | 82.0                  | 80.95                      | 0.91                              | 1.11                                   | 0.345                   | 28.4                    | 323.8                      | 0.453                             | 0.55                                   | 1.38                    | 56.8                    |
| DRQ74-101-R | 100                   | 101.6                      | 0.86                              | 0.99                                   | 0.383                   | 31.8                    | 406.4                      | 0.430                             | 0.49                                   | 1.53                    | 63.6                    |
| DRQ74-151-R | 150                   | 150.0                      | 0.69                              | 0.81                                   | 0.591                   | 38.6                    | 600.0                      | 0.346                             | 0.41                                   | 2.37                    | 77.2                    |
| DRQ74-221-R | 220                   | 227.0                      | 0.56                              | 0.66                                   | 0.907                   | 47.5                    | 908.0                      | 0.279                             | 0.33                                   | 3.63                    | 95                      |
| DRQ74-331-R | 330                   | 335.6                      | 0.45                              | 0.54                                   | 1.41                    | 57.8                    | 1342                       | 0.224                             | 0.27                                   | 5.66                    | 116                     |
| DRQ74-471-R | 470                   | 465.3                      | 0.40                              | 0.46                                   | 1.74                    | 68.1                    | 1861                       | 0.202                             | 0.23                                   | 6.97                    | 136                     |
| DRQ74-681-R | 680                   | 671.2                      | 0.33                              | 0.38                                   | 2.58                    | 81.7                    | 2685                       | 0.166                             | 0.19                                   | 10.3                    | 163                     |
| DRQ74-821-R | 820                   | 812.7                      | 0.31                              | 0.35                                   | 2.93                    | 89.9                    | 3251                       | 0.156                             | 0.17                                   | 11.7                    | 180                     |
| DRQ74-102-R | 1000                  | 1009                       | 0.27                              | 0.31                                   | 3.89                    | 100                     | 4036                       | 0.135                             | 0.16                                   | 15.6                    | 200                     |

1. Open Circuit Inductance Test Parameters: 100 kHz, 0.25 V<sub>rms</sub>, 0.0 Adc  
Parallel: (1,2 -4,3) Series: (1-4) tie (2-3)
2. RMS current for an approximate DT of 40 °C without core loss.  
It is recommended that the temperature of the part not exceed +125 °C.
3. Peak current for approximately 30% roll-off at +20 °C
4. DCR limits @ +20 °C
5. Applied Volt-Time product (V-μs) across the inductor. This value represents the applied V-μs at 100 kHz necessary to generate a core loss equal to 10% of the total losses for a 40 °C temperature rise.

6. Turns Ratio (1:3):(2-4) 1:1
7. Part number definition: DRQxxx-yyy-  
- DRQxxx = product code and size,  
- yyy = inductance value in μH,  
- R = decimal point. If no R is present, third character = # of zeros  
- "-R" suffix = RoHS compliant

Product specifications

| Part Number  | Rated Inductance (μH) | Parallel Ratings           |                                   |  |                         |                         | Series Ratings             |                                   |  |                         |                         |
|--------------|-----------------------|----------------------------|-----------------------------------|--|-------------------------|-------------------------|----------------------------|-----------------------------------|--|-------------------------|-------------------------|
|              |                       | OCL <sup>1</sup> ±20% (μH) | I <sub>rms</sub> <sup>2</sup> (A) | I <sub>sat</sub> <sup>3</sup> (A) Peak | DCR Ω <sup>4</sup> typ. | Volt <sup>5</sup> μ-sec | OCL <sup>1</sup> ±20% (μH) | I <sub>rms</sub> <sup>2</sup> (A) | I <sub>sat</sub> <sup>3</sup> (A) Peak | DCR Ω <sup>4</sup> typ. | Volt <sup>5</sup> μ-sec |
| DRQ125-R47-R | 0.47                  | 0.456                      | 17.6                              | 33.0                                   | 0.0018                  | 3.17                    | 1.824                      | 8.80                              | 16.5                                   | 0.0078                  | 6.34                    |
| DRQ125-1R0-R | 1.00                  | 0.894                      | 15.0                              | 23.6                                   | 0.0024                  | 4.43                    | 3.576                      | 7.51                              | 11.8                                   | 0.0096                  | 8.86                    |
| DRQ125-1R5-R | 1.50                  | 1.478                      | 13.8                              | 18.3                                   | 0.0029                  | 5.70                    | 5.912                      | 6.89                              | 9.15                                   | 0.0114                  | 11.40                   |
| DRQ125-2R2-R | 2.20                  | 2.208                      | 10.9                              | 15.0                                   | 0.0045                  | 6.97                    | 8.832                      | 5.46                              | 7.50                                   | 0.0182                  | 13.9                    |
| DRQ125-3R3-R | 3.30                  | 3.084                      | 9.26                              | 12.7                                   | 0.0063                  | 8.23                    | 12.34                      | 4.63                              | 6.35                                   | 0.0253                  | 16.5                    |
| DRQ125-4R7-R | 4.70                  | 5.274                      | 7.18                              | 9.71                                   | 0.0105                  | 10.8                    | 21.10                      | 3.59                              | 4.86                                   | 0.0420                  | 21.6                    |
| DRQ125-6R8-R | 6.80                  | 6.588                      | 6.64                              | 8.68                                   | 0.0123                  | 12.0                    | 26.35                      | 3.32                              | 4.34                                   | 0.0492                  | 24.0                    |
| DRQ125-8R2-R | 8.20                  | 8.048                      | 5.54                              | 7.86                                   | 0.0176                  | 13.3                    | 32.19                      | 2.77                              | 3.93                                   | 0.0705                  | 26.6                    |
| DRQ125-100-R | 10.0                  | 9.654                      | 5.35                              | 7.17                                   | 0.0189                  | 14.6                    | 38.62                      | 2.67                              | 3.59                                   | 0.0757                  | 29.2                    |
| DRQ125-150-R | 15.0                  | 15.35                      | 4.27                              | 5.69                                   | 0.0298                  | 18.4                    | 61.40                      | 2.13                              | 2.85                                   | 0.120                   | 36.8                    |
| DRQ125-220-R | 22.0                  | 22.36                      | 3.70                              | 4.71                                   | 0.0396                  | 22.2                    | 89.44                      | 1.84                              | 2.36                                   | 0.159                   | 44.4                    |
| DRQ125-330-R | 33.0                  | 33.74                      | 3.28                              | 3.84                                   | 0.0505                  | 27.2                    | 135.0                      | 1.64                              | 1.92                                   | 0.203                   | 54.4                    |
| DRQ125-470-R | 47.0                  | 47.47                      | 2.71                              | 3.24                                   | 0.0740                  | 32.3                    | 189.9                      | 1.35                              | 1.62                                   | 0.297                   | 64.6                    |
| DRQ125-680-R | 68.0                  | 67.91                      | 2.22                              | 2.70                                   | 0.101                   | 38.6                    | 271.6                      | 1.11                              | 1.35                                   | 0.440                   | 77.2                    |
| DRQ125-820-R | 82.0                  | 86.89                      | 2.05                              | 2.39                                   | 0.128                   | 43.7                    | 347.6                      | 1.03                              | 1.20                                   | 0.515                   | 87.4                    |
| DRQ125-101-R | 100                   | 102.7                      | 1.78                              | 2.20                                   | 0.170                   | 47.5                    | 410.8                      | 0.892                             | 1.10                                   | 0.682                   | 95.0                    |
| DRQ125-151-R | 150                   | 151.1                      | 1.48                              | 1.81                                   | 0.248                   | 57.6                    | 604.4                      | 0.739                             | 0.905                                  | 0.991                   | 115.2                   |
| DRQ125-221-R | 220                   | 216.8                      | 1.19                              | 1.51                                   | 0.384                   | 69.0                    | 867.2                      | 0.594                             | 0.755                                  | 1.54                    | 138                     |
| DRQ125-331-R | 330                   | 332.6                      | 1.06                              | 1.22                                   | 0.482                   | 85.5                    | 1330                       | 0.530                             | 0.610                                  | 1.93                    | 171                     |
| DRQ125-471-R | 470                   | 473.1                      | 0.87                              | 1.02                                   | 0.718                   | 102                     | 1892                       | 0.434                             | 0.510                                  | 2.87                    | 204                     |
| DRQ125-681-R | 680                   | 679.8                      | 0.70                              | 0.85                                   | 1.10                    | 122                     | 2719                       | 0.350                             | 0.425                                  | 4.42                    | 244                     |
| DRQ125-821-R | 820                   | 828.0                      | 0.60                              | 0.77                                   | 1.49                    | 135                     | 3312                       | 0.301                             | 0.385                                  | 5.96                    | 270                     |
| DRQ125-102-R | 1000                  | 1008                       | 0.57                              | 0.70                                   | 1.69                    | 149                     | 4032                       | 0.283                             | 0.350                                  | 6.76                    | 298                     |

- Open Circuit Inductance Test Parameters: 100 kHz, 0.25 V<sub>rms</sub>, 0.0 Adc  
Parallel: (1,2 -4,3) Series: (1-4) tie (2-3)
- RMS current for an approximate DT of 40 °C without core loss.  
It is recommended that the temperature of the part not exceed +125 °C.
- Peak current for approximately 30% roll-off at +20 °C
- DCR limits @ +20 °C
- Applied Volt-Time product (V-μs) across the inductor. This value represents the applied V-μs at 100 kHz necessary to generate a core loss equal to 10% of the total losses for a 40 °C temperature rise.

- Turns Ratio (1:3):(2-4) 1:1
- Part number definition: DRQxxx-yyy-  
- DRQxxx = product code and size,  
- yyy = inductance value in μH,  
- R = decimal point. If no R is present, third character = # of zeros  
- "-R" suffix = RoHS compliant

Product specifications

| Part Number  | Rated Inductance (μH) | Parallel Ratings           |                                   |  |                         |                         | Series Ratings             |                                   |  |                         |                         |
|--------------|-----------------------|----------------------------|-----------------------------------|--|-------------------------|-------------------------|----------------------------|-----------------------------------|--|-------------------------|-------------------------|
|              |                       | OCL <sup>1</sup> ±20% (μH) | I <sub>rms</sub> <sup>2</sup> (A) | I <sub>sat</sub> <sup>3</sup> (A) Peak | DCR Ω <sup>4</sup> typ. | Volt <sup>5</sup> μ-sec | OCL <sup>1</sup> ±20% (μH) | I <sub>rms</sub> <sup>2</sup> (A) | I <sub>sat</sub> <sup>3</sup> (A) Peak | DCR Ω <sup>4</sup> typ. | Volt <sup>5</sup> μ-sec |
| DRQ127-R47-R | 0.47                  | 0.419                      | 17.9                              | 56.0                                   | 0.00195                 | 3.50                    | 1.676                      | 8.94                              | 28                                     | 0.0078                  | 7.00                    |
| DRQ127-1R0-R | 1.00                  | 0.821                      | 15.5                              | 40.0                                   | 0.00261                 | 4.90                    | 3.284                      | 7.74                              | 20                                     | 0.0104                  | 9.80                    |
| DRQ127-1R5-R | 1.50                  | 1.357                      | 13.5                              | 31.1                                   | 0.00341                 | 6.30                    | 5.428                      | 6.77                              | 15.6                                   | 0.0137                  | 12.60                   |
| DRQ127-2R2-R | 2.20                  | 2.027                      | 12.5                              | 25.5                                   | 0.00373                 | 7.70                    | 8.108                      | 6.23                              | 12.7                                   | 0.0161                  | 15.4                    |
| DRQ127-3R3-R | 3.30                  | 2.831                      | 10.4                              | 21.5                                   | 0.00567                 | 9.10                    | 11.32                      | 5.23                              | 10.8                                   | 0.0229                  | 18.2                    |
| DRQ127-4R7-R | 4.70                  | 4.841                      | 8.25                              | 16.5                                   | 0.00917                 | 11.9                    | 19.36                      | 4.13                              | 8.24                                   | 0.0367                  | 23.8                    |
| DRQ127-6R8-R | 6.80                  | 7.387                      | 7.34                              | 13.3                                   | 0.0116                  | 14.7                    | 29.55                      | 3.67                              | 6.67                                   | 0.0465                  | 29.4                    |
| DRQ127-8R2-R | 8.20                  | 8.861                      | 6.32                              | 12.2                                   | 0.0157                  | 16.1                    | 35.44                      | 3.16                              | 6.09                                   | 0.0627                  | 32.2                    |
| DRQ127-100-R | 10.0                  | 10.47                      | 6.04                              | 11.2                                   | 0.0172                  | 17.5                    | 41.88                      | 3.02                              | 5.60                                   | 0.0686                  | 35.0                    |
| DRQ127-150-R | 15.0                  | 14.09                      | 5.03                              | 9.66                                   | 0.0247                  | 20.3                    | 56.36                      | 2.51                              | 4.83                                   | 0.0990                  | 40.6                    |
| DRQ127-220-R | 22.0                  | 22.93                      | 4.00                              | 7.57                                   | 0.0391                  | 25.9                    | 91.72                      | 2.00                              | 3.78                                   | 0.157                   | 51.8                    |
| DRQ127-330-R | 33.0                  | 33.92                      | 3.23                              | 6.22                                   | 0.0600                  | 31.5                    | 135.7                      | 1.61                              | 3.11                                   | 0.241                   | 63.0                    |
| DRQ127-470-R | 47.0                  | 47.05                      | 2.95                              | 5.28                                   | 0.0719                  | 37.1                    | 188.2                      | 1.47                              | 2.64                                   | 0.288                   | 74.2                    |
| DRQ127-680-R | 68.0                  | 66.48                      | 2.44                              | 4.44                                   | 0.105                   | 44.1                    | 265.9                      | 1.22                              | 2.22                                   | 0.421                   | 88.2                    |
| DRQ127-820-R | 82.0                  | 79.75                      | 2.09                              | 4.06                                   | 0.143                   | 48.3                    | 319.0                      | 1.04                              | 2.03                                   | 0.573                   | 96.6                    |
| DRQ127-101-R | 100                   | 99.31                      | 1.96                              | 3.64                                   | 0.163                   | 53.9                    | 397.2                      | 0.980                             | 1.82                                   | 0.653                   | 107.8                   |
| DRQ127-151-R | 150                   | 144.9                      | 1.59                              | 3.01                                   | 0.247                   | 65.1                    | 579.6                      | 0.796                             | 1.51                                   | 0.989                   | 130.2                   |
| DRQ127-221-R | 220                   | 221.5                      | 1.29                              | 2.43                                   | 0.376                   | 80.5                    | 886.0                      | 0.645                             | 1.22                                   | 1.50                    | 161                     |
| DRQ127-331-R | 330                   | 323.6                      | 1.04                              | 2.01                                   | 0.574                   | 97.3                    | 1294                       | 0.522                             | 1.01                                   | 2.30                    | 195                     |
| DRQ127-471-R | 470                   | 467.1                      | 0.85                              | 1.68                                   | 0.861                   | 117                     | 1868                       | 0.427                             | 0.838                                  | 3.44                    | 234                     |
| DRQ127-681-R | 680                   | 676.7                      | 0.76                              | 1.39                                   | 1.08                    | 141                     | 2707                       | 0.380                             | 0.697                                  | 4.32                    | 282                     |
| DRQ127-821-R | 820                   | 818.1                      | 0.65                              | 1.27                                   | 1.47                    | 155                     | 3272                       | 0.325                             | 0.633                                  | 5.88                    | 310                     |
| DRQ127-102-R | 1000                  | 1005                       | 0.61                              | 1.14                                   | 1.66                    | 172                     | 4020                       | 0.307                             | 0.571                                  | 6.64                    | 344                     |

- Open Circuit Inductance Test Parameters: 100 kHz, 0.25 V<sub>rms</sub>, 0.0 Adc  
Parallel: (1,2 -4,3) Series: (1-4) tie (2-3)
- RMS current for an approximate DT of 40 °C without core loss.  
It is recommended that the temperature of the part not exceed +125 °C.
- Peak current for approximately 30% roll-off at 20°C
- DCR limits @ +20 °C
- Applied Volt-Time product (V-μs) across the inductor. This value represents the applied V-μs at 100 kHz necessary to generate a core loss equal to 10% of the total losses for a 40 °C temperature rise.

- Turns Ratio (1:3):(2-4) 1:1
- Part number definition: DRQxxx-yyy-  
- DRQxxx = product code and size,  
- yyy = inductance value in μH,  
- R = decimal point. If no R is present, third character = # of zeros  
- "-R" suffix = RoHS compliant

Dimensions - mm

DRQ73

Top View



Side View

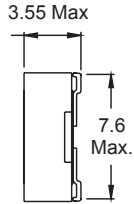

Recommended Pad Layout

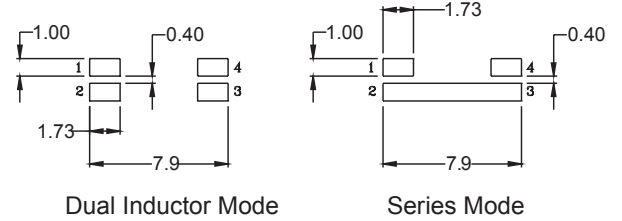

Bottom View

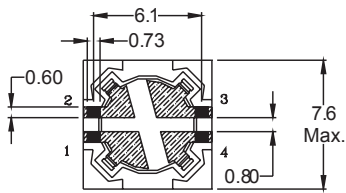

Schematic

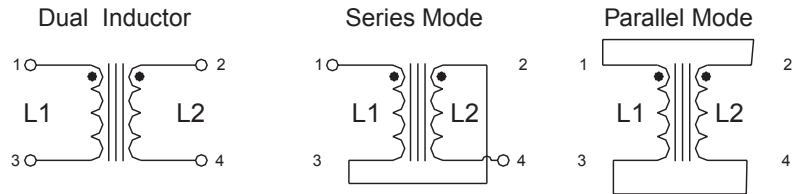

DRQ74

Top View



Side View

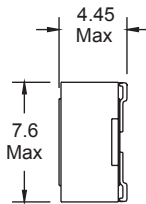

Recommended Pad Layout

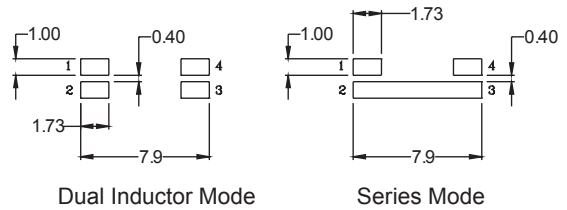

Bottom View

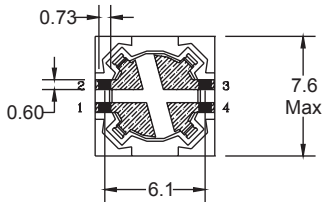

Schematic

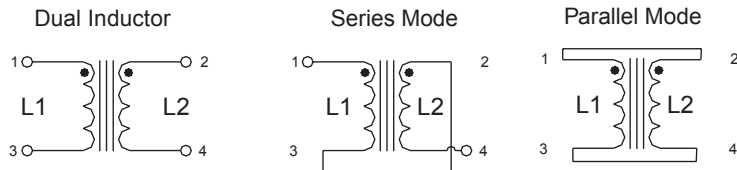

### = Inductance value per family chart  
wlyy = Date code  
R = Revision level  
Dot indicates pin #1  
Do not route traces or vias underneath the inductor

Dimensions - mm

DRQ125

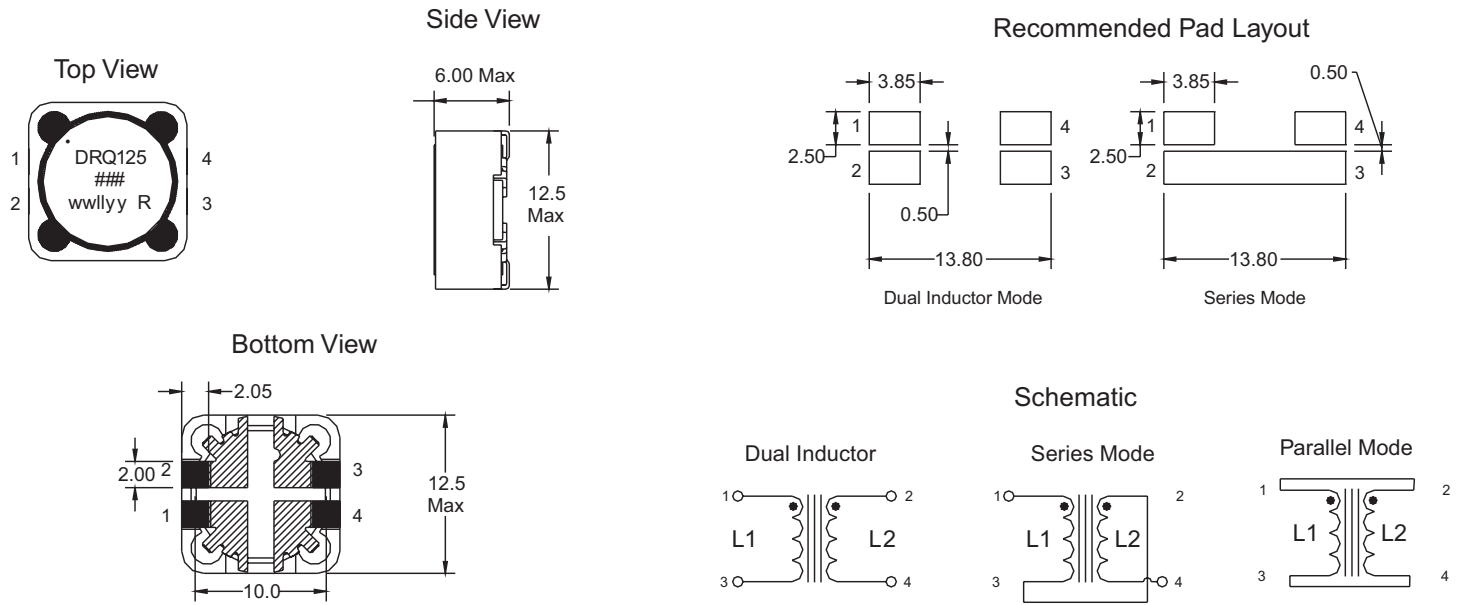

DRQ127

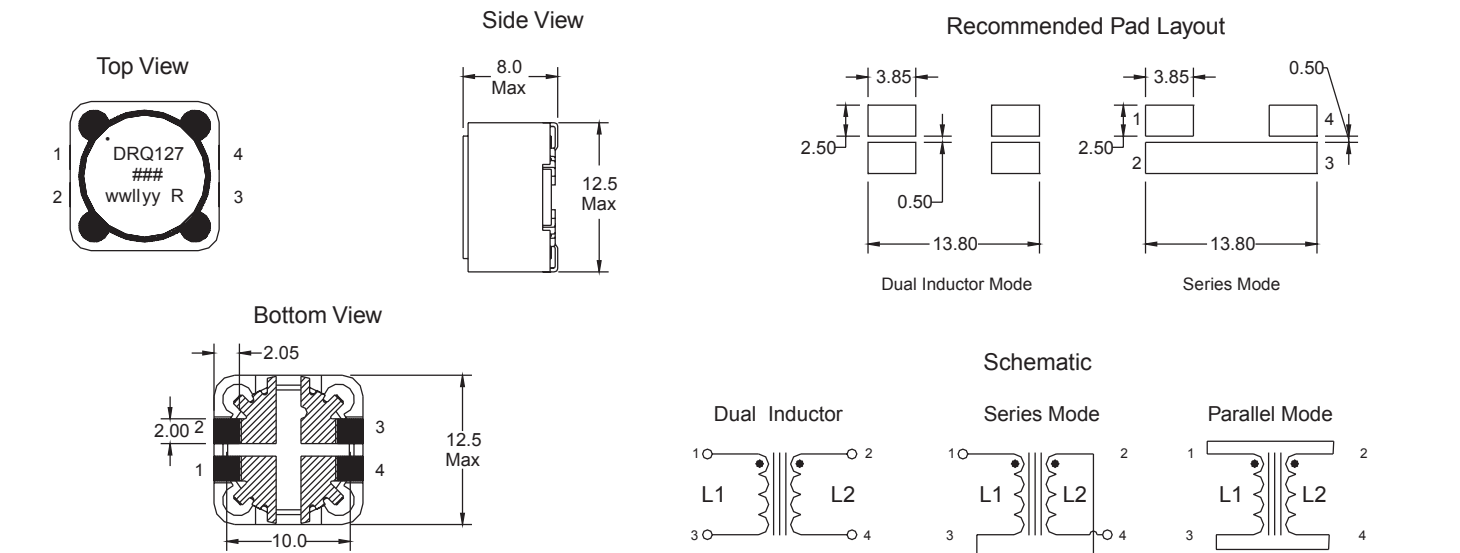

### = Inductance value per family chart  
 wwllly = (date code)  
 R = revision level  
 Dot indicates pin #1  
 Do not route traces or vias underneath the inductor

Dual winding, high power density, shielded drum core power inductors

Packaging information- mm

DRQ73

Supplied in tape and reel packaging,  
1350 parts per reel, 13" diameter reel.

Ao=7.90mm  
Bo=7.90mm  
Ko=3.80mm

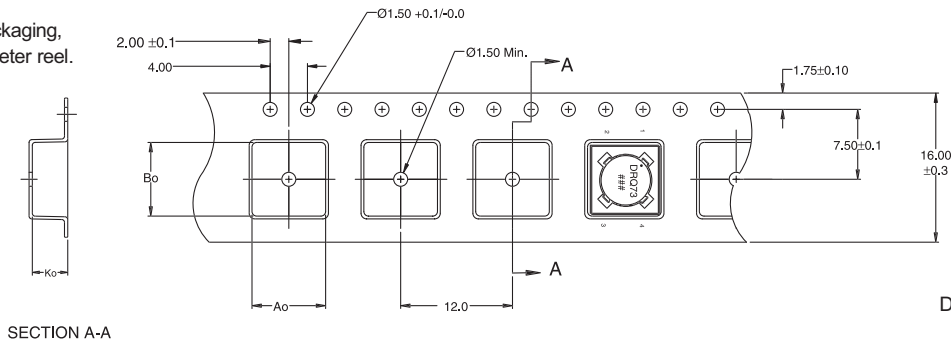

DRQ74

Supplied in tape and reel packaging,  
1100 parts per reel, 13" diameter reel.

Ao=7.90mm  
Bo=7.90mm  
Ko=4.70mm

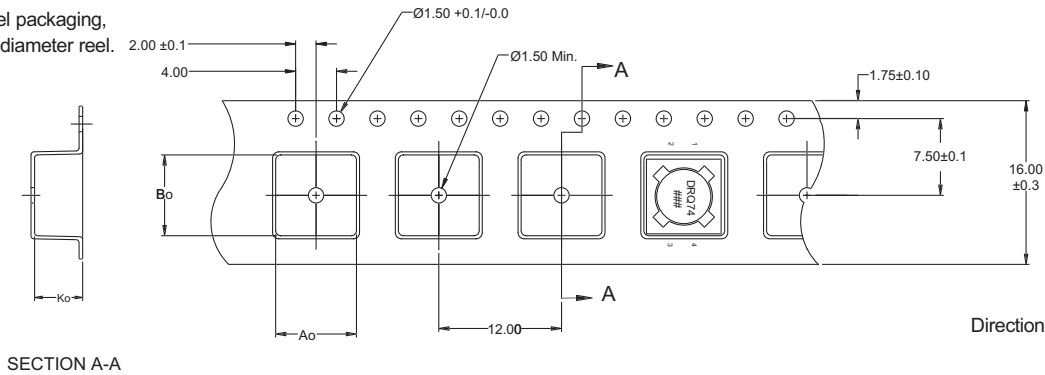

DRQ125

Supplied in tape and reel packaging,  
600 parts per reel, 13" diameter reel.

Ao=13.00mm  
Bo=13.00mm  
Ko=6.30mm

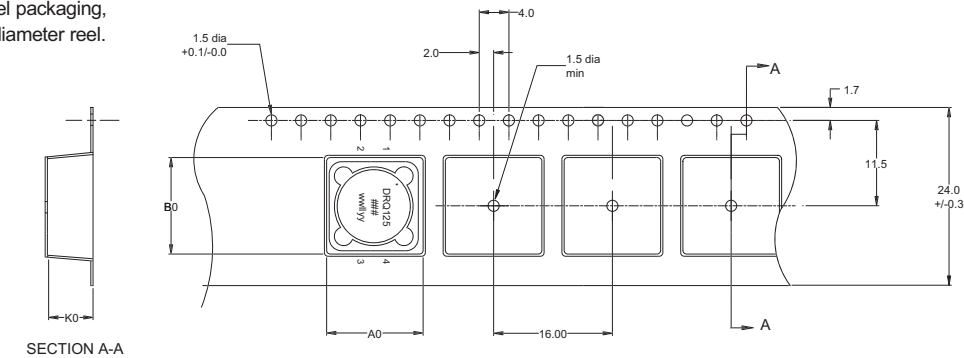

DRQ127

Supplied in tape and reel packaging,  
350 parts per reel, 13" diameter reel.

Ao=13.00mm  
Bo=13.00mm  
Ko=8.30mm

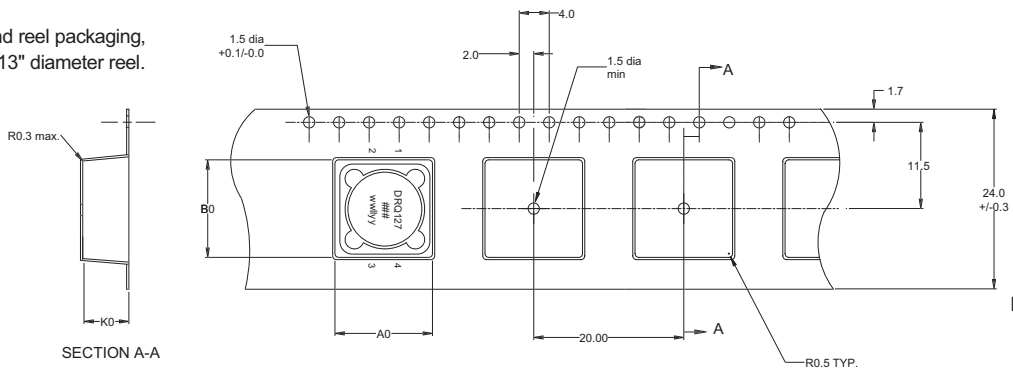

Dimensions are in millimeters.

Core loss

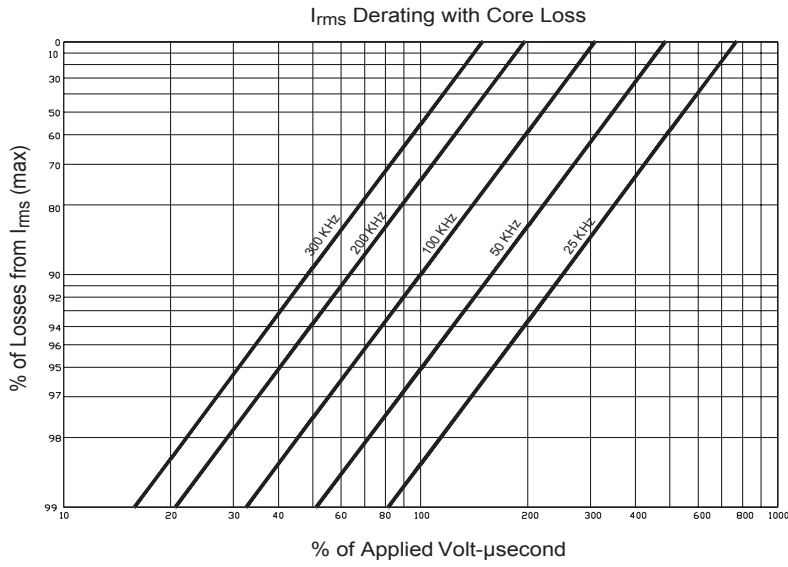

Inductance characteristics

DRQ73

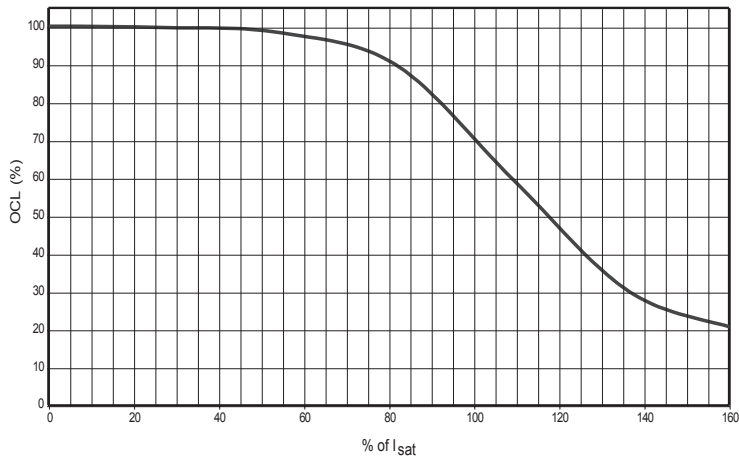

DRQ74

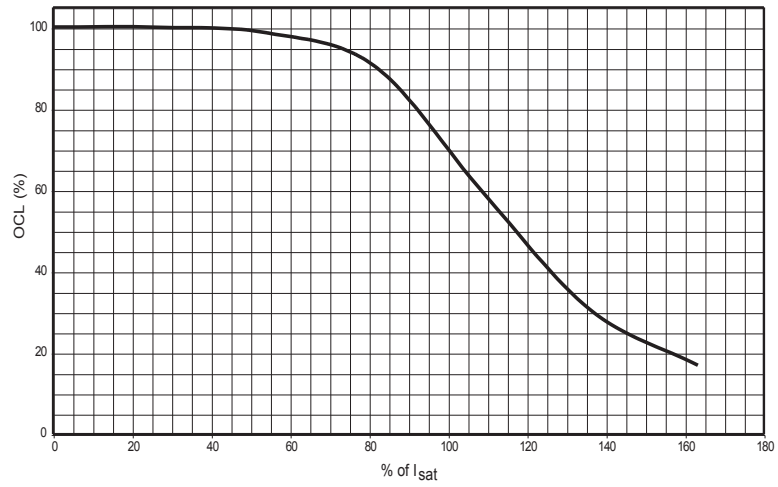

DRQ125

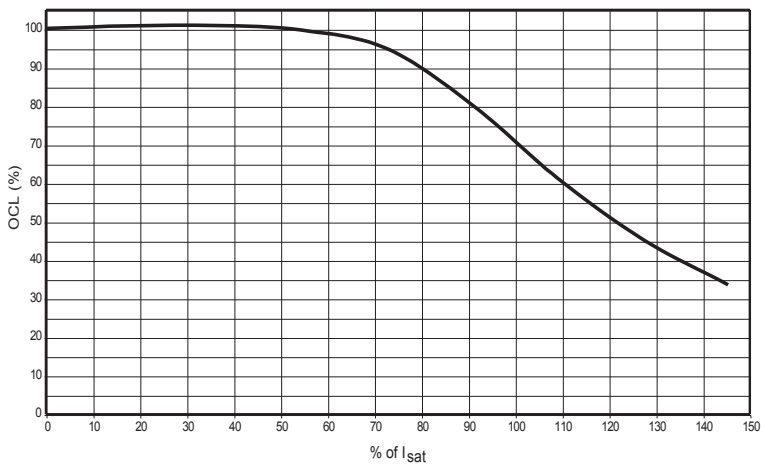

DRQ127

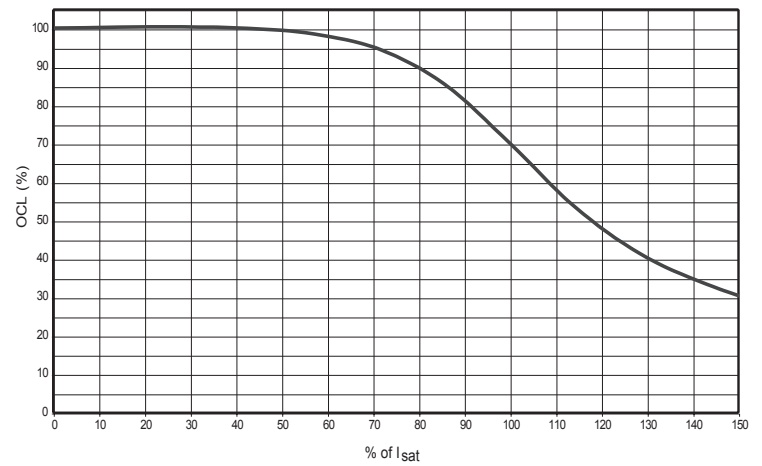



### Solder Reflow Profile

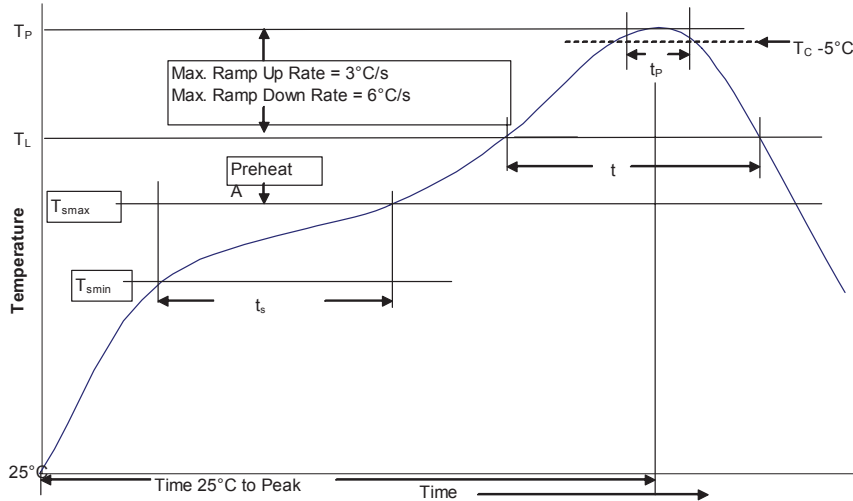

Table 1 - Standard SnPb Solder ( $T_p$ )

| Package Thickness   | Volume $\text{mm}^3$ <350 | Volume $\text{mm}^3$ $\geq 350$ |
|---------------------|---------------------------|---------------------------------|
| <2.5mm              | 235°C                     | 220°C                           |
| $\geq 2.5\text{mm}$ | 220°C                     | 220°C                           |

Table 2 - Lead (Pb) Free Solder ( $T_p$ )

| Package Thickness | Volume $\text{mm}^3$ <350 | Volume $\text{mm}^3$ 350 - 2000 | Volume $\text{mm}^3$ >2000 |
|-------------------|---------------------------|---------------------------------|----------------------------|
| <1.6mm            | 260°C                     | 260°C                           | 260°C                      |
| 1.6 - 2.5mm       | 260°C                     | 250°C                           | 245°C                      |
| >2.5mm            | 250°C                     | 245°C                           | 245°C                      |

### Reference JDEC J-STD-020

| Profile Feature  | Standard SnPb Solder | Lead (Pb) Free Solder |
|--|----------------------|-----------------------|
| Preheat and Soak   |                      |                       |
| • Temperature min. ( $T_{smin}$ )  | 100°C                | 150°C                 |
| • Temperature max. ( $T_{smax}$ )  | 150°C                | 200°C                 |
| • Time ( $T_{smin}$ to $T_{smax}$ ) ( $t_s$ )                                      | 60-120 Seconds       | 60-120 Seconds        |
| Average ramp up rate $T_{smax}$ to $T_p$   | 3°C/ Second Max.     | 3°C/ Second Max.      |
| Liquidous temperature ( $T_L$ )  | 183°C                | 217°C                 |
| Time at liquidous ( $t_L$ )  | 60-150 Seconds       | 60-150 Seconds        |
| Peak package body temperature ( $T_p$ )*   | Table 1              | Table 2               |
| Time ( $t_p$ )** within 5 °C of the specified classification temperature ( $T_c$ ) | 20 Seconds**         | 30 Seconds**          |
| Average ramp-down rate ( $T_p$ to $T_{smax}$ )                                     | 6°C/ Second Max.     | 6°C/ Second Max.      |
| Time 25°C to Peak Temperature  | 6 Minutes Max.       | 8 Minutes Max.        |

\* Tolerance for peak profile temperature ( $T_p$ ) is defined as a supplier minimum and a user maximum.

\*\* Tolerance for time at peak profile temperature ( $t_p$ ) is defined as a supplier minimum and a user maximum.

Life Support Policy: Eaton does not authorize the use of any of its products for use in life support devices or systems without the express written approval of an officer of the Company. Life support systems are devices which support or sustain life, and whose failure to perform, when properly used in accordance with instructions for use provided in the labeling, can be reasonably expected to result in significant injury to the user.

Eaton reserves the right, without notice, to change design or construction of any products and to discontinue or limit distribution of any products. Eaton also reserves the right to change or update, without notice, any technical information contained in this bulletin.

**Eaton**  
Electronics Division  
1000 Eaton Boulevard  
Cleveland, OH 44122  
United States  
www.eaton.com/electronics

© 2017 Eaton  
All Rights Reserved Printed in USA  
Publication No. DS4311 BU-SB14113  
September 2017

Eaton is a registered trademark.

All other trademarks are property of their respective owners.