

Electrical Characteristics (T_A=25°C unless otherwise noted)

Part Number		Marking Code		Breakdown Voltage VBR (Volts) @ IT		Test Current IT (mA)	Reverse Stand off Voltage VR (V)	Maximum Reverse Leakage @ VR IR (µA)	Maximum Peak Pulse Current Ipp (A) 10*1000us	Maximum Clamping Voltage @Ipp VC (V) 10*1000us	Agency Approval	
Uni	Bi	Uni	Bi	MIN	MAX						Uni	Bi
SMF5.0A	SMF5.0CA	AE	HE	6.40	7.00	10	5.0	400	21.7	9.2	X	-
SMF6.0A	SMF6.0CA	AG	HG	6.67	7.37	10	6.0	400	19.4	10.3	X	-
SMF6.5A	SMF6.5CA	AK	HK	7.22	7.98	10	6.5	250	17.9	11.2	X	-
SMF7.0A	SMF7.0CA	AM	HM	7.78	8.60	10	7.0	100	16.7	12.0	X	-
SMF7.5A	SMF7.5CA	AP	HP	8.33	9.21	1	7.5	50	15.5	12.9	X	-
SMF8.0A	SMF8.0CA	AR	HR	8.89	9.83	1	8.0	25	14.7	13.6	X	-
SMF8.5A	SMF8.5CA	AT	HT	9.44	10.40	1	8.5	10	13.9	14.4	X	-
SMF9.0A	SMF9.0CA	AV	HV	10.00	11.10	1	9.0	5	13.0	15.4	X	-
SMF10A	SMF10CA	AX	HX	11.10	12.30	1	10	2.5	11.8	17.0	X	-
SMF11A	SMF11CA	AZ	HZ	12.20	13.50	1	11	2.5	11.0	18.2	X	-
SMF12A	SMF12CA	BE	IE	13.30	14.70	1	12	2.5	10.1	19.9	X	-
SMF13A	SMF13CA	BG	IG	14.40	15.90	1	13	1.0	9.3	21.5	X	-
SMF14A	SMF14CA	BK	IK	15.60	17.20	1	14	1.0	8.6	23.2	X	-
SMF15A	SMF15CA	BM	IM	16.70	18.50	1	15	1.0	8.2	24.4	X	-
SMF16A	SMF16CA	BP	IP	17.80	19.70	1	16	1.0	7.7	26.0	X	-
SMF17A	SMF17CA	BR	IR	18.90	20.90	1	17	1.0	7.2	27.6	X	-
SMF18A	SMF18CA	BT	IT	20.00	22.10	1	18	1.0	6.8	29.2	X	-
SMF20A	SMF20CA	BV	IV	22.20	24.50	1	20	1.0	6.2	32.4	X	-
SMF22A	SMF22CA	BX	IX	24.40	26.90	1	22	1.0	5.6	35.5	X	-
SMF24A	SMF24CA	BZ	IZ	26.70	29.50	1	24	1.0	5.1	38.9	X	-
SMF26A	SMF26CA	CE	JE	28.90	31.90	1	26	1.0	4.8	42.1	X	-
SMF28A	SMF28CA	CG	JG	31.10	34.40	1	28	1.0	4.4	45.4	X	-
SMF30A	SMF30CA	CK	JK	33.30	36.80	1	30	1.0	4.1	48.4	X	-
SMF33A	SMF33CA	CM	JM	36.70	40.60	1	33	1.0	3.8	53.3	X	-
SMF36A	SMF36CA	CP	JP	40.00	44.20	1	36	1.0	3.4	58.1	X	-
SMF40A	SMF40CA	CR	JR	44.40	49.10	1	40	1.0	3.1	64.5	X	-
SMF43A	SMF43CA	CT	JT	47.80	52.80	1	43	1.0	2.9	69.4	X	-
SMF45A	SMF45CA	CV	JV	50.00	55.30	1	45	1.0	2.8	72.7	X	-
SMF48A	SMF48CA	CX	JX	53.30	58.90	1	48	1.0	2.6	77.4	X	-
SMF51A	SMF51CA	CZ	JZ	56.70	62.70	1	51	1.0	2.4	82.4	X	-
SMF54A	SMF54CA	DE	KE	60.00	66.30	1	54	1.0	2.3	87.1	X	-
SMF58A	SMF58CA	RG	KG	64.40	71.20	1	58	1.0	2.1	93.6	-	-
SMF60A	SMF60CA	RK	KK	66.70	73.70	1	60	1.0	2.1	96.8	-	-
SMF64A	SMF64CA	RM	KM	71.10	78.60	1	64	1.0	1.9	103.0	-	-
SMF70A	SMF70CA	RP	KP	77.80	86.00	1	70	1.0	1.7	113.0	-	-
SMF75A	SMF75CA	RR	KR	83.30	92.10	1	75	1.0	1.6	121.0	-	-
SMF78A	SMF78CA	RT	KT	86.70	95.80	1	78	1.0	1.6	126.0	-	-
SMF85A	SMF85CA	RV	KV	94.40	104.00	1	85	1.0	1.5	137.0	-	-
SMF90A	SMF90CA	RW	KX	100.00	111.00	1	90	1.0	1.2	146.0	-	-
SMF100A	SMF100CA	RX	KZ	111.00	123.00	1	100	1.0	1.1	162.0	-	-
SMF110A	SMF110CA	SE	LE	122.00	135.00	1	110	1.0	1.1	177.0	-	-
SMF120A	SMF120CA	SG	LG	133.00	147.00	1	120	1.0	1.0	193.0	-	-
SMF130A	SMF130CA	SK	LK	144.00	159.00	1	130	1.0	1.0	209.0	-	-
SMF150A	SMF150CA	SM	LM	167.00	185.00	1	150	1.0	0.8	243.0	-	-
SMF160A	SMF160CA	SP	LP	178.00	197.00	1	160	1.0	0.8	259.0	-	-
SMF170A	SMF170CA	SR	LR	189.00	209.00	1	170	1.0	0.7	275.0	-	-
SMF180A	SMF180CA	ST	LT	201.00	222.00	1	180	1.0	0.7	292.0	-	-
SMF188A	SMF188CA	SV	LV	209.00	231.00	1	188	1.0	0.7	304.0	-	-
SMF200A	SMF200CA	SX	LX	224.00	247.00	1	200	1.0	0.6	324.0	-	-
SMF220A	SMF220CA	SZ	LZ	246.00	272.00	1	220	1.0	0.6	356.0	-	-
SMF250A	SMF250CA	TE	ME	279.00	309.00	1	250	1.0	0.5	405.0	-	-

-Notes:

1. V_{BR} measured after I_T applied for 300µs, I_T = square wave pulse or equivalent.
2. Surge current waveform per 10/1000µs exponential wave and derated per Fig.2.
3. All terms and symbols are consistent with ANSI/IEEE C62.35.
4. For bidirectional type having VR of 10 volts and less, the IR limit is double.

I-V Curve Characteristics

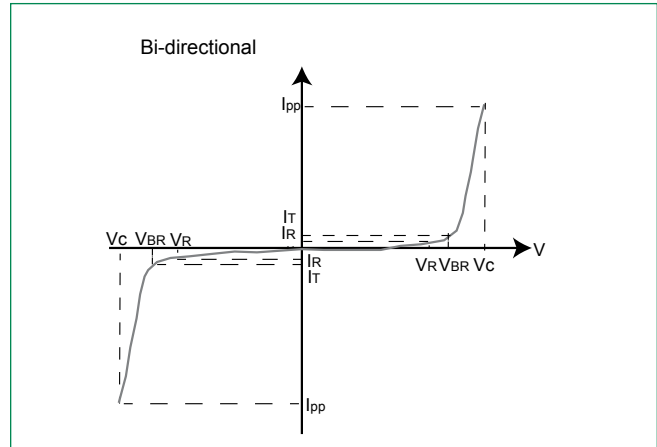
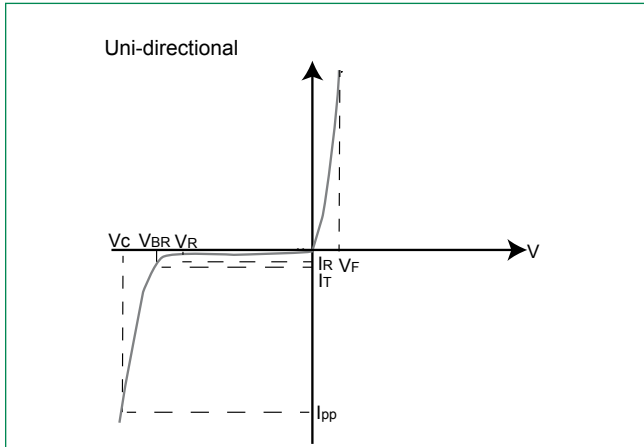

- P_{PPM} **Peak Pulse Power Dissipation** – Max power dissipation
- V_R **Stand-off Voltage** – Maximum voltage that can be applied to the TVS without operation
- V_{BR} **Breakdown Voltage** – Maximum voltage that flows through the TVS at a specified test current (I_T)
- V_C **Clamping Voltage** – Peak voltage measured across the TVS at a specified I_{ppm} (peak impulse current)
- I_R **Reverse Leakage Current** – Current measured at V_R
- V_F **Forward Voltage Drop for Uni-directional**

Ratings and Characteristic Curves ($T_A=25^\circ\text{C}$ unless otherwise noted)

Figure 1 - TVS Transients Clamping Waveform

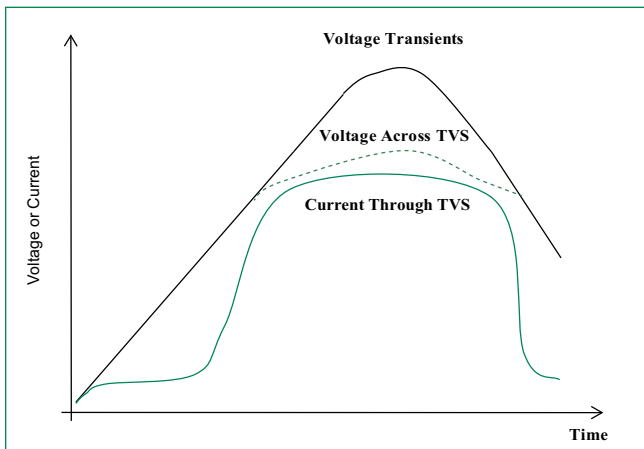
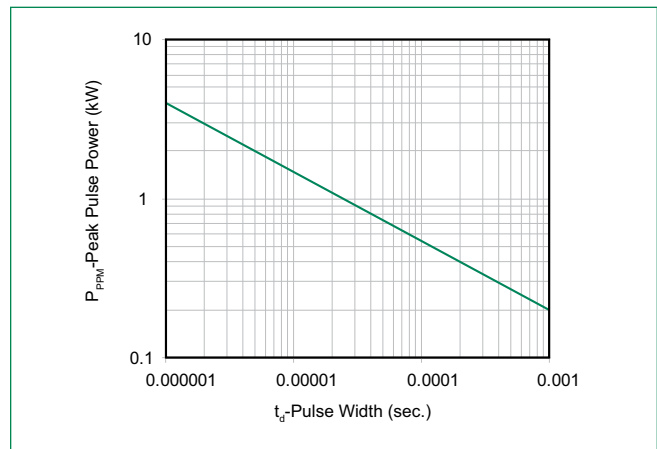

Figure 2 - Peak Pulse Power Rating Curve



Ratings and Characteristic Curves ($T_A=25^\circ\text{C}$ unless otherwise noted) (Continued)

Figure 3 - Peak Pulse Power Derating Curve

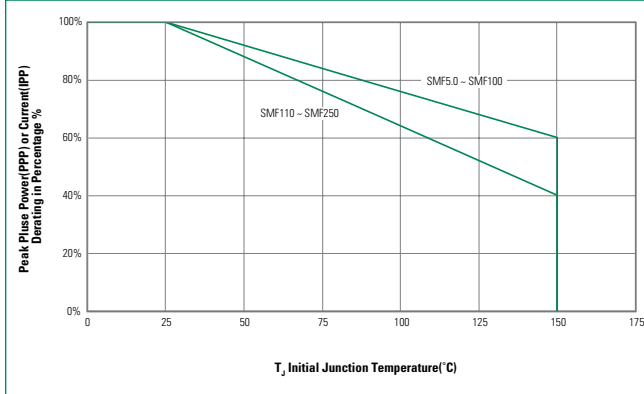

Figure 4 - Pulse Waveform - 10/1000 μs

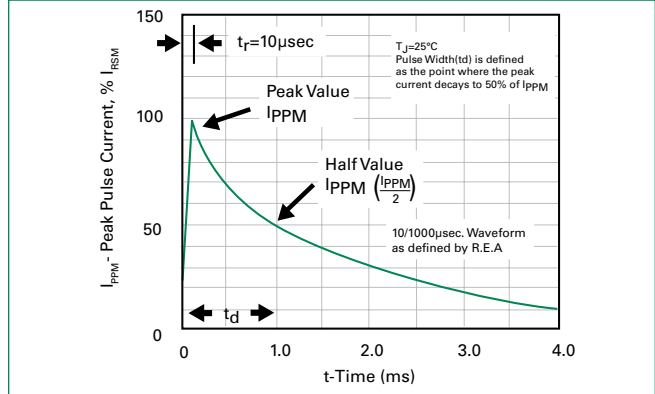

Figure 5 - Forward Voltage

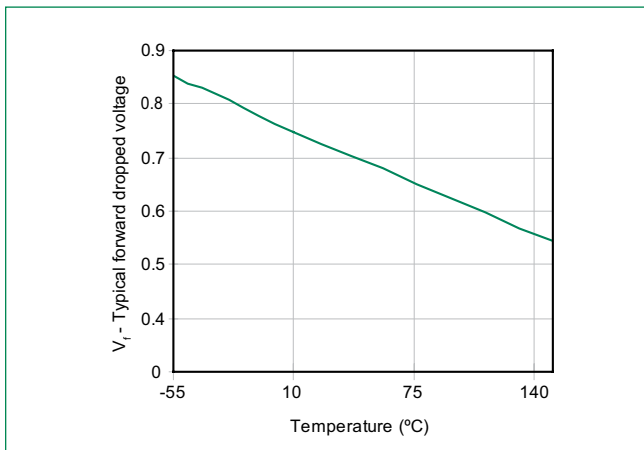

Figure 6 - Typical Junction Capacitance

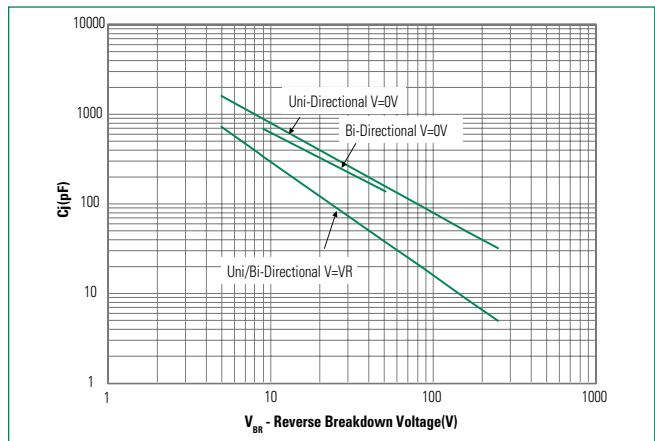

Figure 7 - Peak Forward Voltage Drop vs. Peak Forward Current

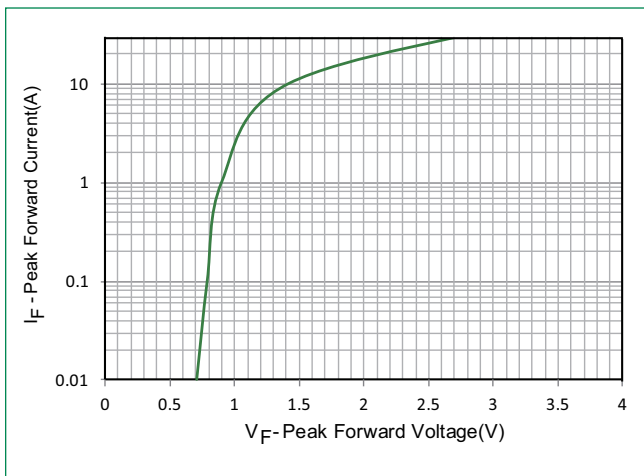
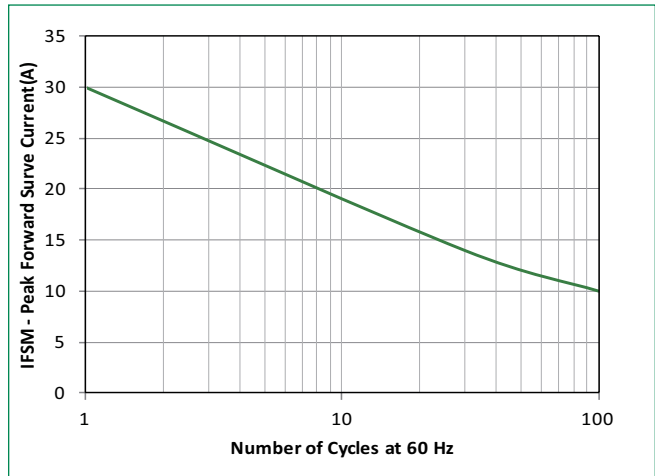
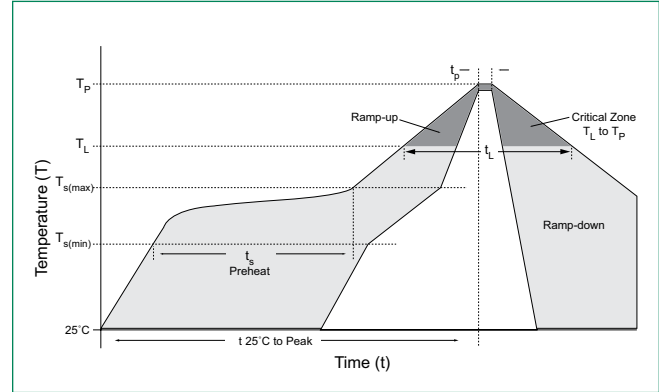

Figure 8 - Maximum Non-Repetitive Forward Surge Current Uni-Directional Only



Soldering Parameters

Reflow Condition		Lead-free assembly
Pre Heat	- Temperature Min ($T_{s(min)}$)	150°C
	- Temperature Max ($T_{s(max)}$)	200°C
	- Time (min to max) (t_s)	60 – 120 secs
Average ramp up rate (Liquidus Temp (T_L) to peak)		3°C/second max
$T_{s(max)}$ to T_L - Ramp-up Rate		3°C/second max
Reflow	- Temperature (T_L) (Liquidus)	217°C
	- Time (min to max) (t_L)	60 – 150 seconds
Peak Temperature (T_p)		260 ^{+0/-5} °C
Time within 5°C of actual peak temperature (t_p)		30 Seconds Max
Ramp-down Rate		6°C/second Max
Time 25°C to peak Temperature (T_p)		8 minutes Max.
Do not exceed		260°C



Physical Specifications

Case	SOD-123FL plastic over glass passivated junction
Polarity	Color band denotes cathode except bipolar
Terminal	Matte tin-plated leads, solderable per JESD22-B102

Environmental Specifications

High Temp. Storage	JESD22-A103
HTRB	JESD22-A108
Temperature Cycling	JESD22-A104
MSL	JEDEC-J-STD-020, Level 1
H3TRB	JESD22-A101
RSH	JESD22-A111

Dimensions - SOD-123FL Package

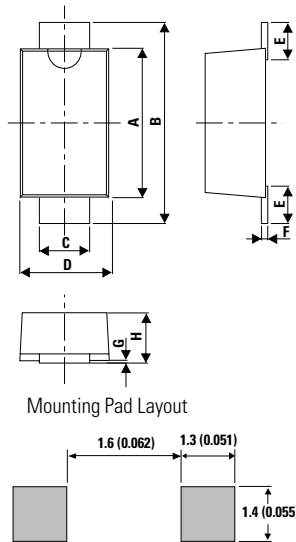

Dimensions	Millimeters		Inches		
	Min	Max	Min	Max	
A	SMF5.0A~SMF100A	2.50	2.90	0.0984	0.1142
	SMF110A~SMF250A	2.90	3.10	0.1142	0.1220
	SMF5.0CA~SMF250CA				
B		3.40	3.90	0.1339	0.1535
C		0.70	1.20	0.0275	0.0472
D		1.50	2.00	0.0591	0.0787
E		0.35	0.90	0.0138	0.0354
F		0.05	0.26	0.0020	0.0102
G		0.00	0.10	0.000	0.0039
H	SMF5.0A~SMF100A	0.95	1.10	0.0374	0.0433
	SMF110A~SMF250A	0.90	1.08	0.0354	0.0425
	SMF5.0CA~SMF250CA				

Part Numbering System

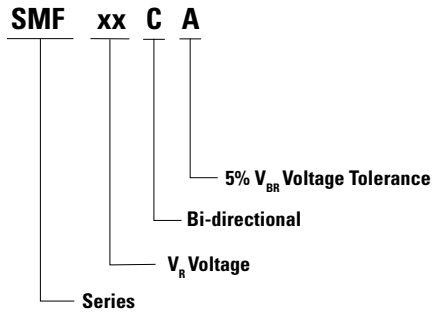

Part Marking System

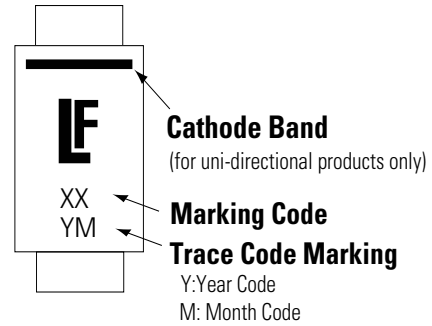

Packaging Options

Part number	Component Package	Quantity	Packaging Option	Packaging Specification
SMFXXX	SOD-123FL	3000	Tape & Reel – 8mm tape/7" reel	EIA RS-481
SMFXXX-T13	SOD-123FL	10000	Tape & Reel – 8mm tape/13" reel	EIA RS-481

Tape and Reel Specification

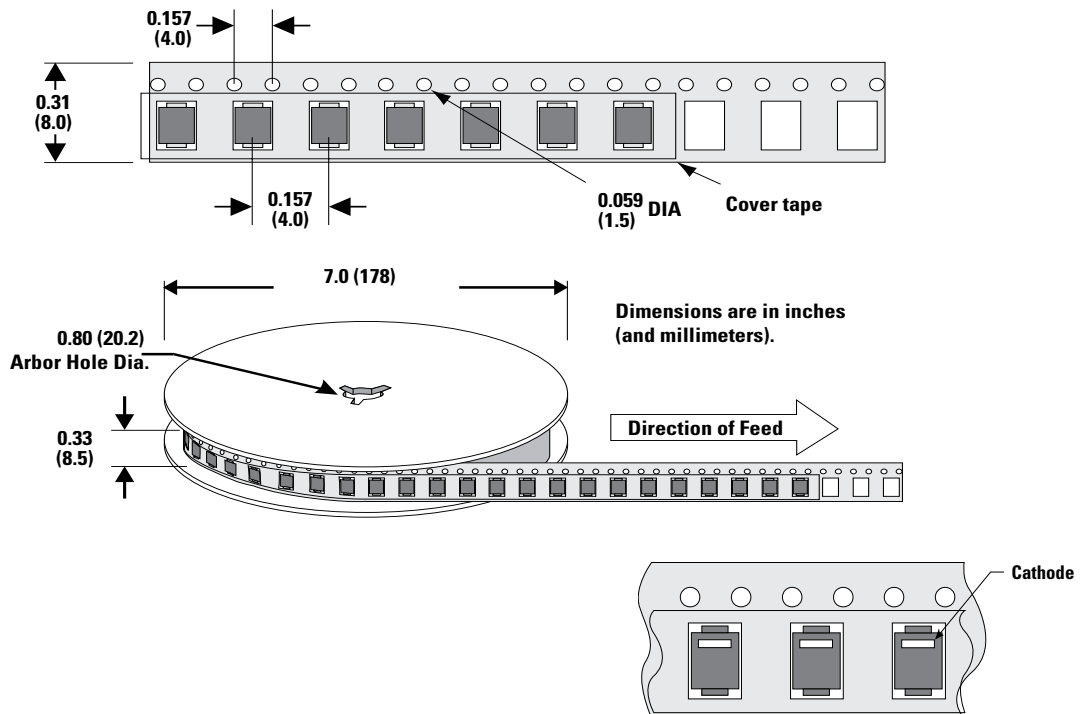

Disclaimer Notice - Information furnished is believed to be accurate and reliable. However, users should independently evaluate the suitability of and test each product selected for their own applications. Littelfuse products are not designed for, and may not be used in, all applications. Read complete Disclaimer Notice at www.littelfuse.com/disclaimer-electronics.

© 2020 Littelfuse, Inc.
Specifications are subject to change without notice.
Revised: 01/02/20