

**PACKAGE/ORDERING INFORMATION**

MODEL	PACKAGE DESCRIPTION	SPECIFIED TEMPERATURE RANGE	ORDERING NUMBER	PACKAGE MARKING	PACKING OPTION
SGM8749	SC70-5	-40°C to +85°C	SGM8749YC5G/TR	SS1XX	Tape and Reel, 3000
	SOT-23-5	-40°C to +85°C	SGM8749YN5G/TR	SS2XX	Tape and Reel, 3000

**MARKING INFORMATION**

NOTE: XX = Date Code.

**SOT-23-5/SC70-5**

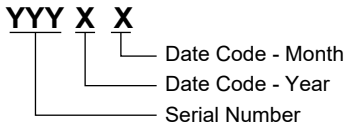

Green (RoHS & HSF): SG Micro Corp defines "Green" to mean Pb-Free (RoHS compatible) and free of halogen substances. If you have additional comments or questions, please contact your SGMICRO representative directly.

**ABSOLUTE MAXIMUM RATINGS**

Supply Voltage, +V <sub>S</sub> to -V <sub>S</sub> .....	6V
V <sub>IN</sub> Differential .....	±(+V <sub>S</sub> - (-V <sub>S</sub> ))
Voltage at Input/Output Pins .....	(-V <sub>S</sub> ) - 0.3V to (+V <sub>S</sub> ) + 0.3V
Junction Temperature .....	+150°C
Storage Temperature Range .....	-65°C to +150°C
Lead Temperature (Soldering, 10s) .....	+260°C
ESD Susceptibility	
HBM .....	2000V
MM .....	400V

Failure to observe proper handling and installation procedures can cause damage. ESD damage can range from subtle performance degradation to complete device failure. Precision integrated circuits may be more susceptible to damage because very small parametric changes could cause the device not to meet its published specifications.

**RECOMMENDED OPERATING CONDITIONS**

Operating Temperature Range .....	-40°C to +85°C
Operating Supply Voltage Range .....	2.7V to 5.5V

**DISCLAIMER**

SG Micro Corp reserves the right to make any change in circuit design, or specifications without prior notice.

**OVERSTRESS CAUTION**

Stresses beyond those listed in Absolute Maximum Ratings may cause permanent damage to the device. Exposure to absolute maximum rating conditions for extended periods may affect reliability. Functional operation of the device at any conditions beyond those indicated in the Recommended Operating Conditions section is not implied.

**PIN CONFIGURATIONS**

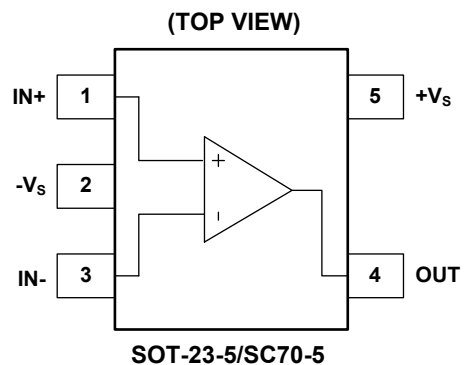

**ESD SENSITIVITY CAUTION**

This integrated circuit can be damaged by ESD if you don't pay attention to ESD protection. SGMICRO recommends that all integrated circuits be handled with appropriate precautions.

**ELECTRICAL CHARACTERISTICS**(V<sub>S</sub> = 5V, V<sub>CM</sub> = 0V, C<sub>L</sub> = 15pF, typical values are at T<sub>A</sub> = +25°C, unless otherwise noted.)

PARAMETER	SYMBOL	CONDITIONS	MIN	TYP	MAX	UNITS
Operating Supply Voltage Range <sup>(1)</sup>	V <sub>S</sub>		2.7		5.5	V
Input Common Mode Voltage Range <sup>(2)</sup>	V <sub>CM</sub>		-0.1		V <sub>S</sub> + 0.1	V
Input Offset Voltage	V <sub>OS</sub>	V <sub>S</sub> = 5V, V <sub>CM</sub> = 0V, Out = 0V		0.8	4.5	mV
		-40°C to +85°C			4.7	
		V <sub>S</sub> = 5V, V <sub>CM</sub> = 5V, Out = 0V		0.9	4.8	
		-40°C to +85°C			4.9	
Output Short-Circuit Current	I <sub>SINK</sub>	V <sub>S</sub> = 5V, Out to V <sub>S</sub> /2		-33	-28	mA
		-40°C to +85°C			-22	
Common Mode Rejection Ratio <sup>(3)</sup>	CMRR	V <sub>S</sub> = 5V, V <sub>CM</sub> = 0V to 5V	60	77		dB
		-40°C to +85°C	58			
Power Supply Rejection Ratio	PSRR	V <sub>CM</sub> = 0V, V <sub>S</sub> = 2.7V to 5.5V	68	79		dB
		-40°C to +85°C	66			
Output Voltage Swing from Rail	V <sub>OL</sub>	V <sub>S</sub> = 5V, I <sub>OUT</sub> = -4mA		185	218	mV
		-40°C to +85°C			262	
Supply Current	I <sub>S</sub>	V <sub>S</sub> = 3V, I <sub>OUT</sub> = 0		22	32	μA
		-40°C to +85°C			38	
		V <sub>S</sub> = 5V, I <sub>OUT</sub> = 0		25	35	
		-40°C to +85°C			44	
Propagation Delay (High to Low)		V <sub>S</sub> = 3V, Overdrive = 10mV		150		ns
		V <sub>S</sub> = 3V, Overdrive = 100mV		97		
Fall Time	t <sub>FALL</sub>	Overdrive = 10mV		8		ns
		Overdrive = 100mV		6		

## NOTES:

1. Inferred from PSRR test.
2. Inferred from PD test. Note also that either or both inputs can be driven to the absolute maximum limit (0.1V beyond either supply rail) without damage or false output inversion.
3. Specified over the full input common mode voltage range (V<sub>CM</sub>).

TYPICAL PERFORMANCE CHARACTERISTICS

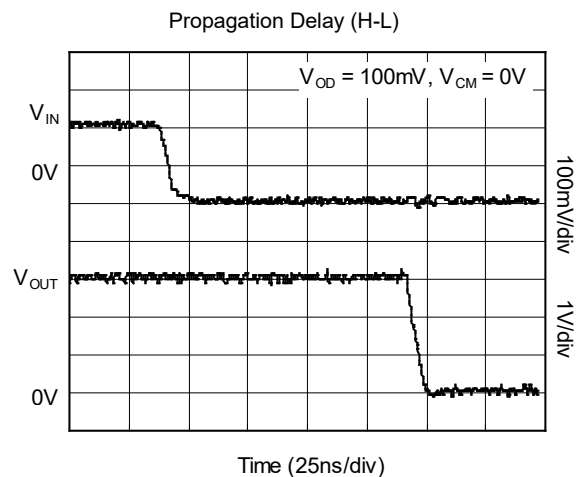
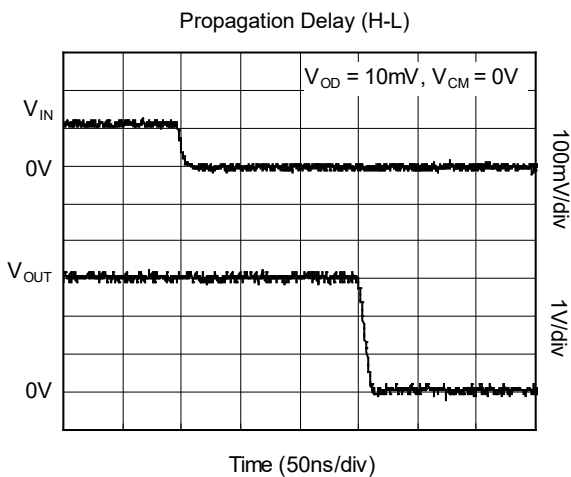
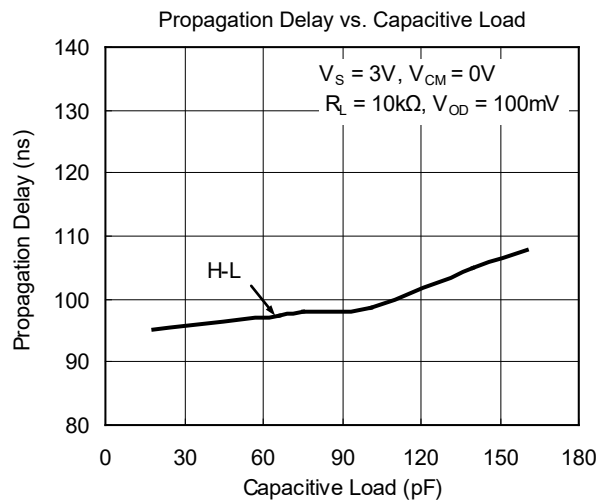
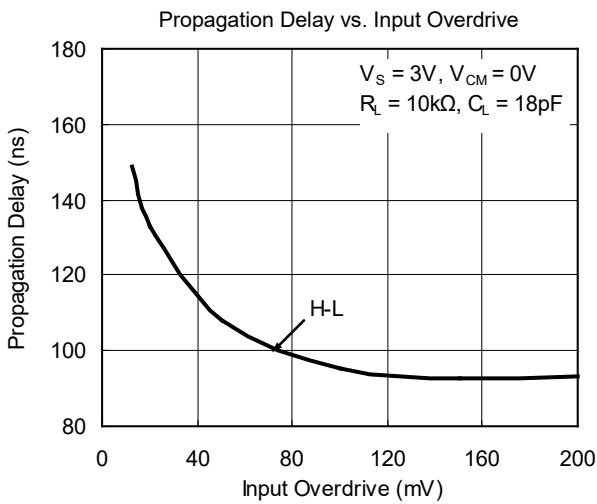
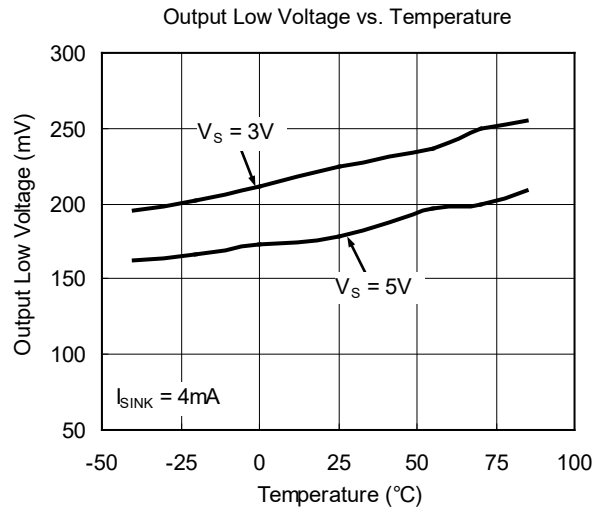
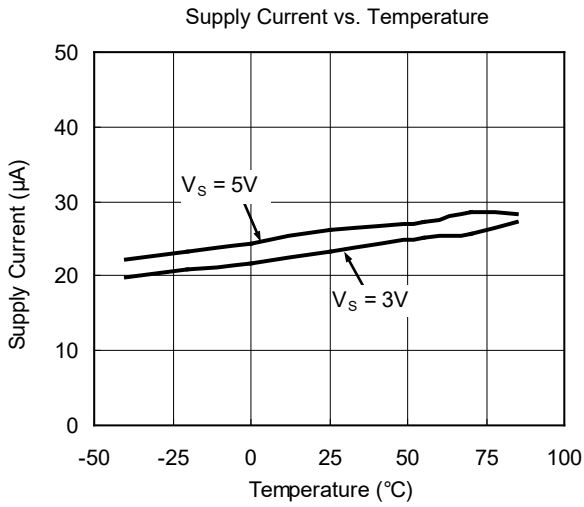

TYPICAL PERFORMANCE CHARACTERISTICS (continued)

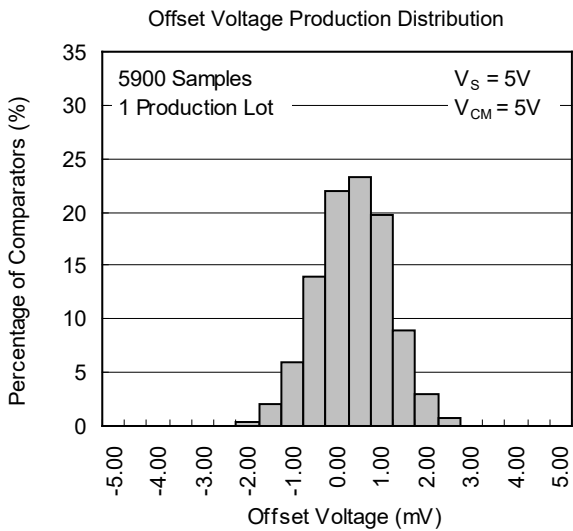
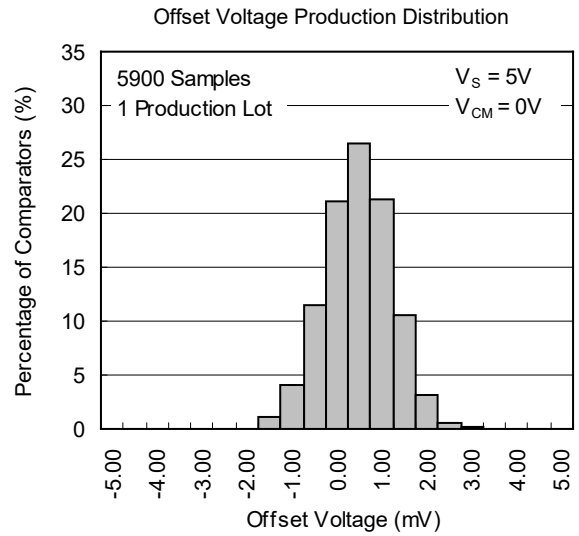
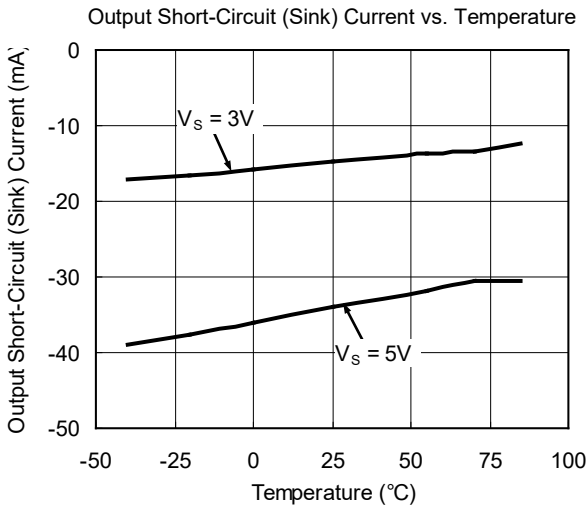

## DETAILED DESCRIPTION

The SGM8749 is a single-supply comparator that features high speed, and low power. Its output is pulled to within 185mV of either supply rail without external pull-up or pull-down circuitry. Rail-to-rail input voltage range and low-voltage single-supply operation make the device ideal for portable equipment. The SGM8749 interfaces directly to CMOS and TTL logics.

### Output Stage Circuitry

The SGM8749 contains an open drain current-driven output stage as shown in Figure 1. During an output transition,  $I_{SINK}$  is pulled output pin to Logic Low. The output sink current is high during the transition, creating a rapid slew rate. Once the output voltage reaches  $V_{OL}$ , the sink current decreases to a small value, capable of maintaining the  $V_{OL}$  static condition. This significant decrease in current conserves power after an output transition has occurred.

One consequence of a current-driven output stage is a linear dependence between the slew rate and the load capacitance. A heavy capacitive load will slow down a

voltage output transition. This can be useful in noise-sensitive applications where fast edges may cause interference.

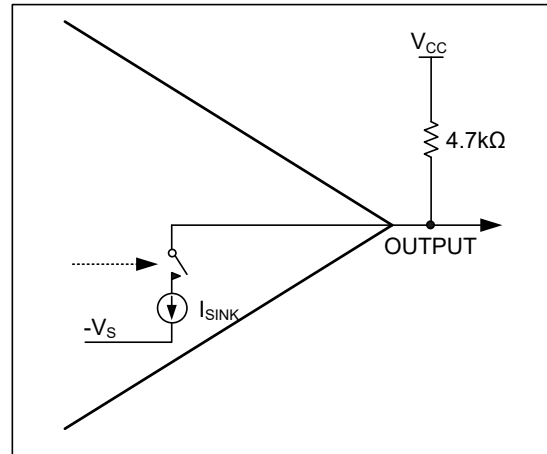

Figure 1. Open Drain Output Stage Circuitry

APPLICATION INFORMATION

Circuit Layout and Bypassing

The high gain-bandwidth product of the SGM8749 requires design precautions to realize the full high-speed capabilities of the comparator. The recommended precautions are:

- 1) Use a PCB with a good, unbroken, low-inductance ground plane.
- 2) Place a decoupling capacitor (a 0.1µF ceramic capacitor is a good choice) as close to +V<sub>S</sub> as possible.
- 3) Pay close attention to the decoupling capacitor's bandwidth, keeping leads short.
- 4) On the inputs and output, keep lead lengths short to avoid unwanted parasitic feedback around the comparator.
- 5) Solder the device directly to the PCB instead of using a socket.

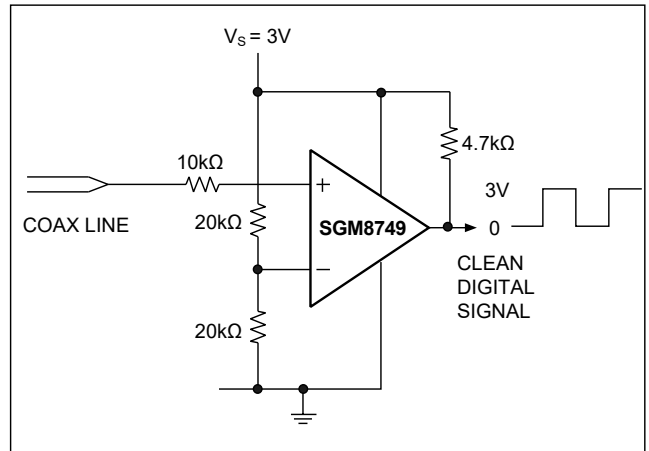

Figure 3. Line Receiver Application

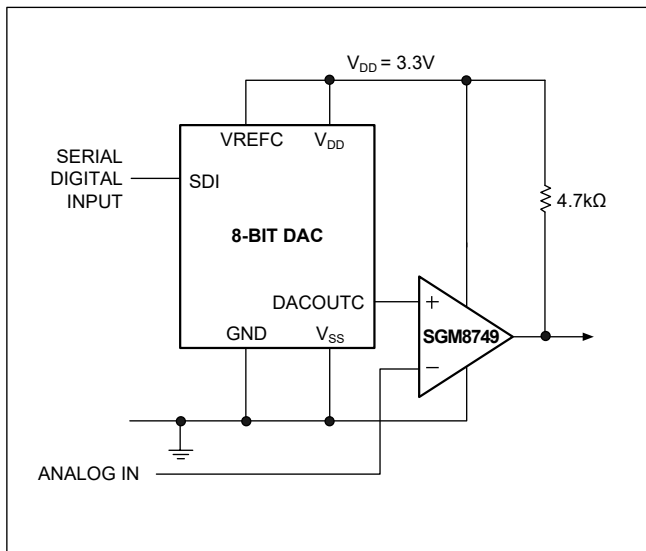

Figure 2. 3.3V Digitally Controlled Threshold Detector

REVISION HISTORY

NOTE: Page numbers for previous revisions may differ from page numbers in the current version.

Changes from Original (JUNE 2015) to REV.A

Changed from product preview to production data.....	All
--	-----

# PACKAGE INFORMATION

## PACKAGE OUTLINE DIMENSIONS

### SOT-23-5

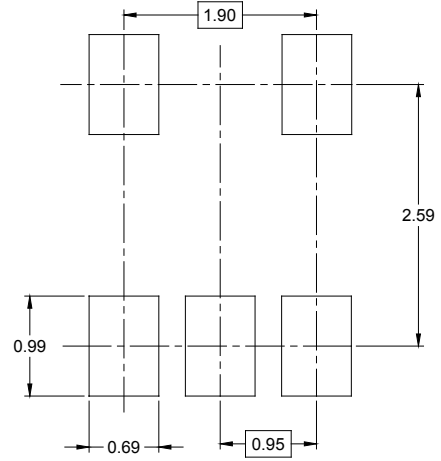
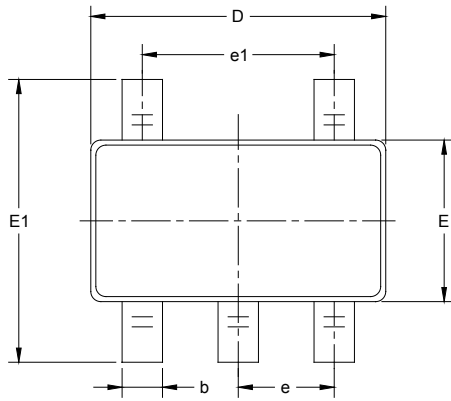

RECOMMENDED LAND PATTERN (Unit: mm)

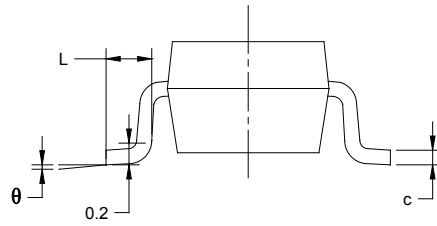
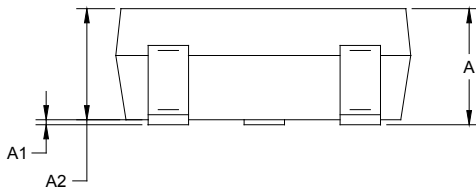

Symbol	Dimensions In Millimeters		Dimensions In Inches	
	MIN	MAX	MIN	MAX
A	1.050	1.250	0.041	0.049
A1	0.000	0.100	0.000	0.004
A2	1.050	1.150	0.041	0.045
b	0.300	0.500	0.012	0.020
c	0.100	0.200	0.004	0.008
D	2.820	3.020	0.111	0.119
E	1.500	1.700	0.059	0.067
E1	2.650	2.950	0.104	0.116
e	0.950 BSC		0.037 BSC	
e1	1.900 BSC		0.075 BSC	
L	0.300	0.600	0.012	0.024
$\theta$	0°	8°	0°	8°

PACKAGE OUTLINE DIMENSIONS

SC70-5

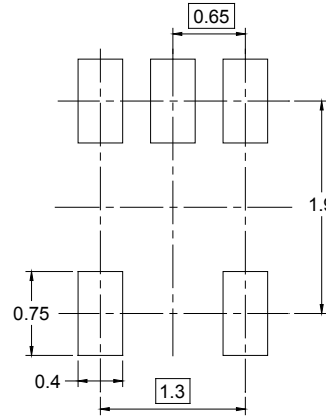
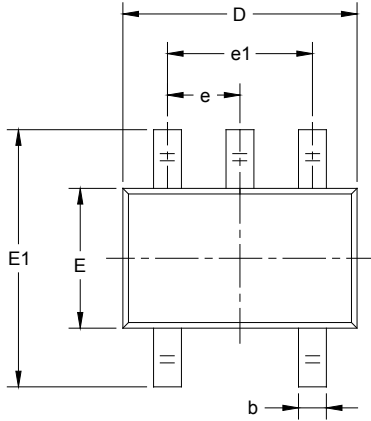

RECOMMENDED LAND PATTERN (Unit: mm)

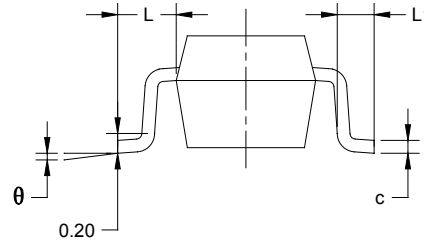
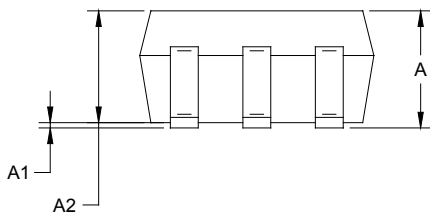

Symbol	Dimensions In Millimeters		Dimensions In Inches	
	MIN	MAX	MIN	MAX
A	0.900	1.100	0.035	0.043
A1	0.000	0.100	0.000	0.004
A2	0.900	1.000	0.035	0.039
b	0.150	0.350	0.006	0.014
c	0.080	0.150	0.003	0.006
D	2.000	2.200	0.079	0.087
E	1.150	1.350	0.045	0.053
E1	2.150	2.450	0.085	0.096
e	0.65 TYP		0.026 TYP	
e1	1.300 BSC		0.051 BSC	
L	0.525 REF		0.021 REF	
L1	0.260	0.460	0.010	0.018
$\theta$	0°	8°	0°	8°



# PACKAGE INFORMATION

## TAPE AND REEL INFORMATION

### REEL DIMENSIONS



### TAPE DIMENSIONS



NOTE: The picture is only for reference. Please make the object as the standard.

### KEY PARAMETER LIST OF TAPE AND REEL

Package Type	Reel Diameter	Reel Width W1 (mm)	A0 (mm)	B0 (mm)	K0 (mm)	P0 (mm)	P1 (mm)	P2 (mm)	W (mm)	Pin1 Quadrant
SOT-23-5	7"	9.5	3.20	3.20	1.40	4.0	4.0	2.0	8.0	Q3
SC70-5	7"	9.5	2.25	2.55	1.20	4.0	4.0	2.0	8.0	Q3

DD0001

# PACKAGE INFORMATION

## CARTON BOX DIMENSIONS



NOTE: The picture is only for reference. Please make the object as the standard.

## KEY PARAMETER LIST OF CARTON BOX

Reel Type	Length (mm)	Width (mm)	Height (mm)	Pizza/Carton
7" (Option)	368	227	224	8
7"	442	410	224	18

DD0002