

## ABSOLUTE MAXIMUM RATINGS

|  |                         |
|--|-------------------------|
| Supply Voltage .....                         | ±18V                    |
| Input Current .....                          | ±10mA                   |
| Input Voltage .....                          | Equal to Supply Voltage |
| Output Short Circuit Duration (Note 1) ..... | Continuous              |
| Operating Temperature Range .....            | 0°C to 70°C             |
| Storage Temperature Range .....              | -65°C to 150°C          |
| Junction Temperature .....                   | 150°C                   |
| Lead Temperature (Soldering, 10 sec.) .....  | 300°C                   |

## PACKAGE/ORDER INFORMATION

|  |                        |
|--|------------------------|
|  | ORDER PART NUMBER      |
|  | LT1217CN8<br>LT1217CS8 |
|  | S8 PART MARKING        |
|  | 1217                   |

## ELECTRICAL CHARACTERISTICS

$V_S = \pm 15V$ ,  $T_A = 0^\circ C$  to  $70^\circ C$  unless otherwise noted.

| SYMBOL    | PARAMETER  | CONDITIONS  | MIN    | TYP        | MAX  | UNITS    |
|-----------|--|---|--------|------------|------|----------|
| $V_{OS}$  | Input Offset Voltage                               | $V_{CM} = 0V$   | ●      | ±1         | ±3   | mV       |
| $I_{IN+}$ | Non-Inverting Input Current                        | $V_{CM} = 0V$   | ●      | ±100       | ±500 | nA       |
| $I_{IN-}$ | Inverting Input Current                            | $V_{CM} = 0V$   | ●      | ±100       | ±500 | nA       |
| $e_n$     | Input Noise Voltage Density                        | $f = 1kHz, R_F = 1k, R_G = 10\Omega$  |        | 6.5        |      | nV/√Hz   |
| $i_n$     | Input Noise Current Density                        | $f = 1kHz, R_F = 1k, R_G = 10\Omega$  |        | 0.7        |      | pA/√Hz   |
| $R_{IN}$  | Input Resistance                                   | $V_{IN} = \pm 10V$  | ●      | 20         | 100  | MΩ       |
| $C_{IN}$  | Input Capacitance                                  |   |        | 1.5        |      | pF       |
|           | Input Voltage Range                                |   | ●      | ±10        | ±12  | V        |
| CMRR      | Common Mode Rejection Ratio                        | $V_{CM} = \pm 10V$  | ●      | 60         | 66   | dB       |
|           | Inverting Input Current Common Mode Rejection      | $V_{CM} = \pm 10V$  | ●      | 5          | 20   | nA/V     |
| PSRR      | Power Supply Rejection Ratio                       | $V_S = \pm 4.5V$ to $\pm 18V$   | ●      | 68         | 76   | dB       |
|           | Non-Inverting Input Current Power Supply Rejection | $V_S = \pm 4.5V$ to $\pm 18V$   | ●      | 2          | 20   | nA/V     |
|           | Inverting Input Current Power Supply Rejection     | $V_S = \pm 4.5V$ to $\pm 18V$   | ●      | 10         | 50   | nA/V     |
| $A_V$     | Large Signal Voltage Gain                          | $R_{LOAD} = 2k, V_{OUT} = \pm 10V$<br>$R_{LOAD} = 400\Omega, V_{OUT} = \pm 10V$ | ●<br>● | 90<br>70   | 105  | dB<br>dB |
| $R_{OL}$  | Transresistance, $\Delta V_{OUT}/\Delta I_{IN-}$   | $R_{LOAD} = 2k, V_{OUT} = \pm 10V$<br>$R_{LOAD} = 400\Omega, V_{OUT} = \pm 10V$ | ●<br>● | 5<br>1.5   | 45   | MΩ<br>MΩ |
| $V_{OUT}$ | Output Swing                                       | $R_{LOAD} = 2k$<br>$R_{LOAD} = 200\Omega$                                       | ●<br>● | ±12<br>±10 | ±13  | V<br>V   |
| $I_{OUT}$ | Output Current                                     | $R_{LOAD} = 0\Omega$  | ●      | 50         | 100  | mA       |
| SR        | Slew Rate (Note 2, 3)                              | $R_F = 3k, R_G = 3k$  | ●      | 100        | 500  | V/μs     |
| BW        | Bandwidth  | $R_F = 3k, R_G = 3k, V_{OUT} = 100mV$   |        | 10         |      | MHz      |
| $t_r$     | Rise Time, Fall Time (Note 3)                      | $R_F = 3k, R_G = 3k, V_{OUT} = 1V$  | ●      | 30         | 40   | ns       |
| $t_{PD}$  | Propagation Delay                                  | $R_F = 3k, R_G = 3k, V_{OUT} = 1V$  |        | 25         |      | ns       |
|           | Overshoot  | $R_F = 3k, R_G = 3k, V_{OUT} = 1V$  |        | 5          |      | %        |
| $t_s$     | Settling Time, 0.1%                                | $R_F = 3k, R_G = 3k, V_{OUT} = 10V$   |        | 280        |      | ns       |
| $I_S$     | Supply Current                                     | $V_{IN} = 0V$   | ●      | 1          | 2    | mA       |
|           | Supply Current, Shutdown                           | Pin 8 Current = 50μA  | ●      | 350        | 1000 | μA       |

The ● denotes specifications which apply over the operating temperature range.

**Note 1:** A heat sink may be required.

**Note 2:** Non-Inverting operation,  $V_{OUT} = \pm 10V$ , measured at  $\pm 5V$ .

**Note 3:** AC parameters are 100% tested on the plastic DIP packaged parts (N suffix), and are sample tested on every lot of the SO packaged parts (S suffix).

# TYPICAL PERFORMANCE CHARACTERISTICS

**Voltage Gain and Phase vs Frequency, Gain = 6dB**

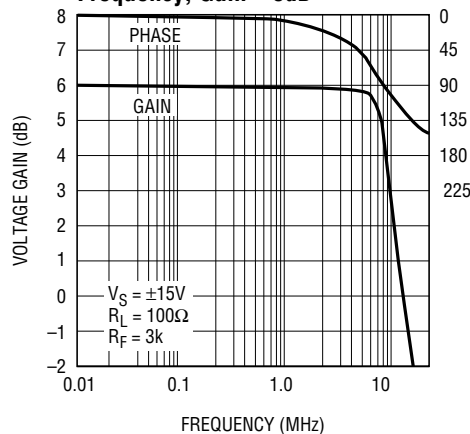

LT1217 • TPC01

**-3dB Bandwidth vs Supply Voltage, Gain = 2, R<sub>L</sub> = 100Ω**

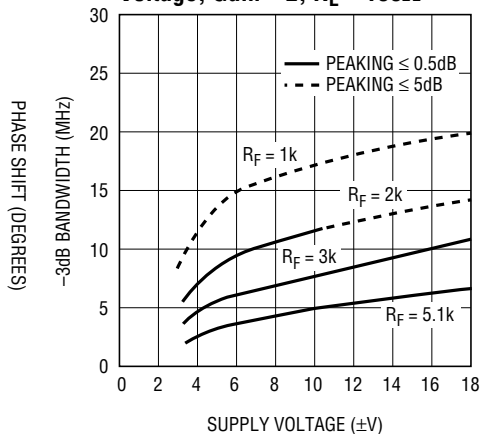

LT1217 • TPC02

**-3dB Bandwidth vs Supply Voltage, Gain = 2, R<sub>L</sub> = 1kΩ**

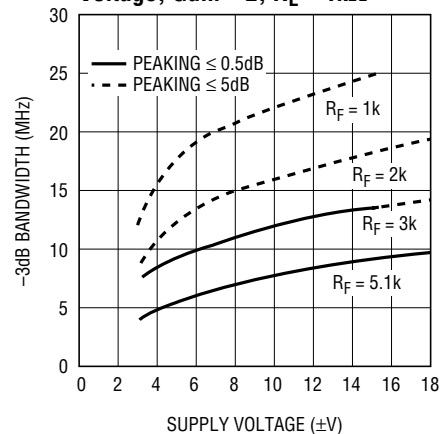

LT1217 • TPC03

**Voltage Gain and Phase vs Frequency, Gain = 20dB**

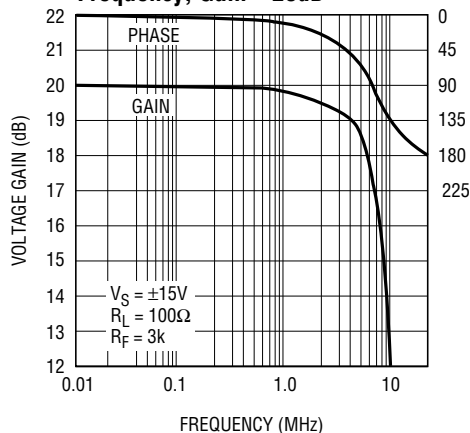

LT1217 • TPC04

**-3dB Bandwidth vs Supply Voltage, Gain = 10, R<sub>L</sub> = 100Ω**

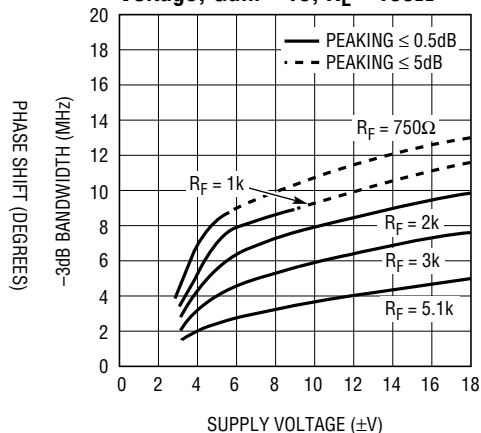

LT1217 • TPC05

**-3dB Bandwidth vs Supply Voltage, Gain = 10, R<sub>L</sub> = 1kΩ**

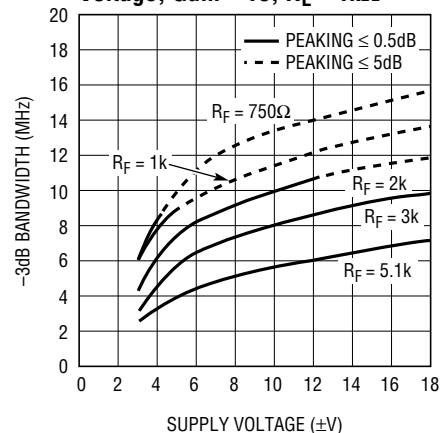

LT1217 • TPC06

**Voltage Gain and Phase vs Frequency, Gain = 40dB**

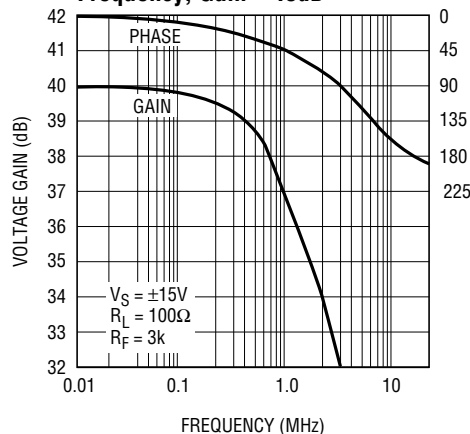

LT1217 • TPC07

**-3dB Bandwidth vs Supply Voltage, Gain = 100, R<sub>L</sub> = 100Ω**

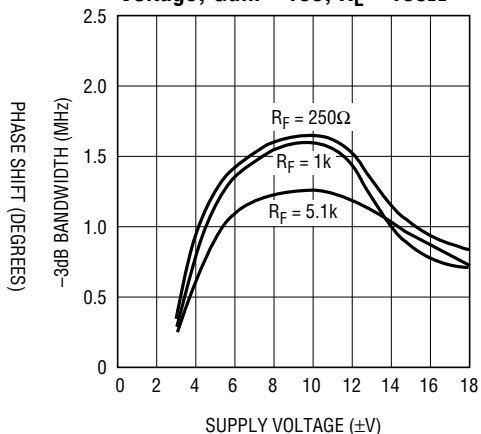

LT1217 • TPC08

**-3dB Bandwidth vs Supply Voltage, Gain = 100, R<sub>L</sub> = 1kΩ**

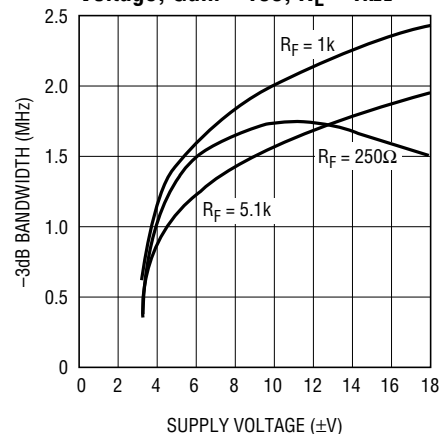

LT1217 • TPC09

# TYPICAL PERFORMANCE CHARACTERISTICS

**Maximum Capacitive Load vs Feedback Resistor**

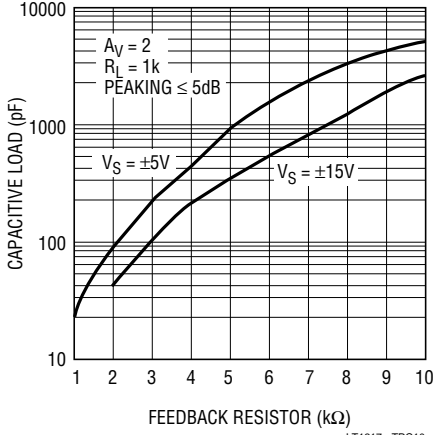

LT1217 • TPC10

**Total Harmonic Distortion vs Frequency**

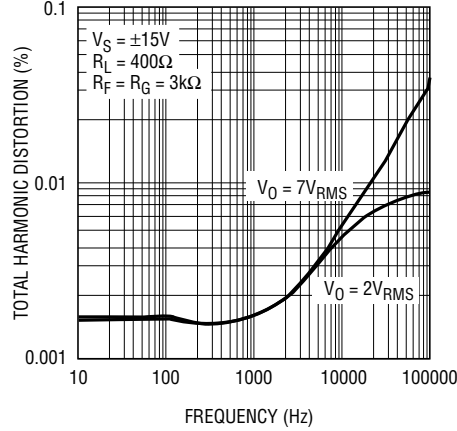

LT1217 • TPC11

**2nd and 3rd Harmonic Distortion vs Frequency**

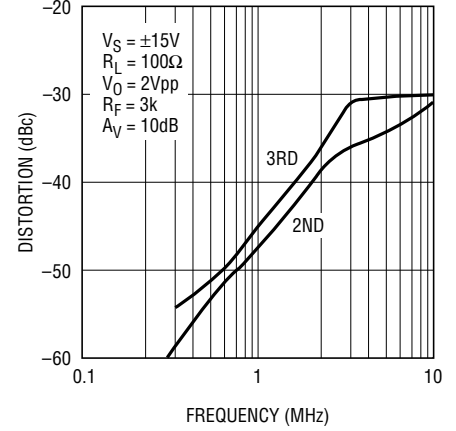

LT1217 • TPC12

**Input Common Mode Limit vs Temperature**

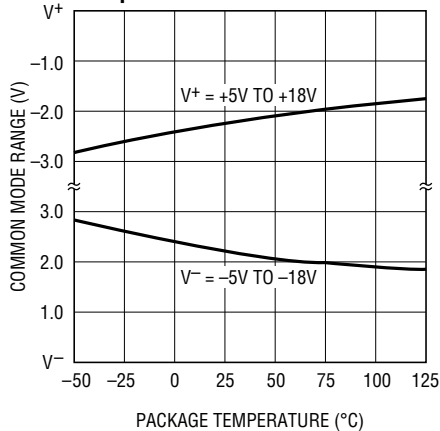

LT1217 • TPC13

**Output Saturation Voltage vs Temperature**

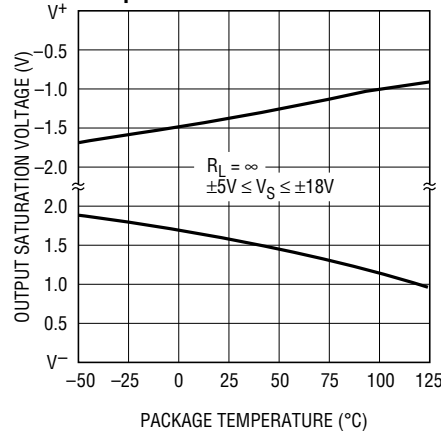

LT1217 • TPC14

**Output Short Circuit Current vs Temperature**

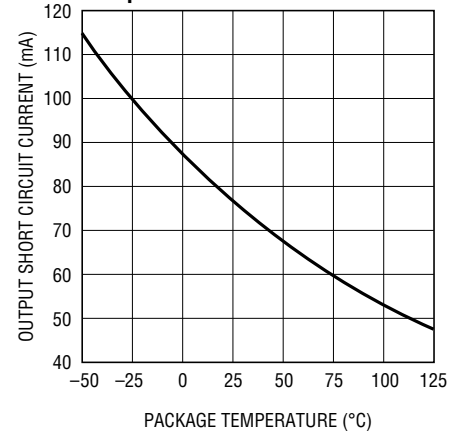

LT1217 • TPC15

**Spot Noise Voltage and Current vs Frequency**

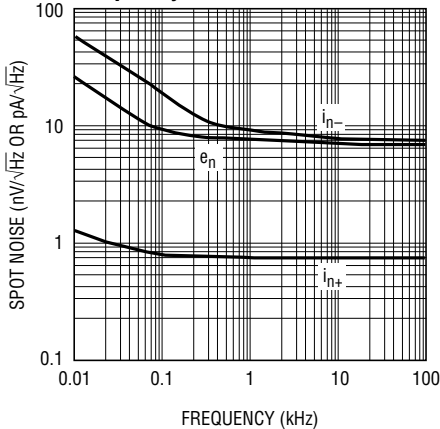

LT1217 • TPC16

**Power Supply Rejection vs Frequency**

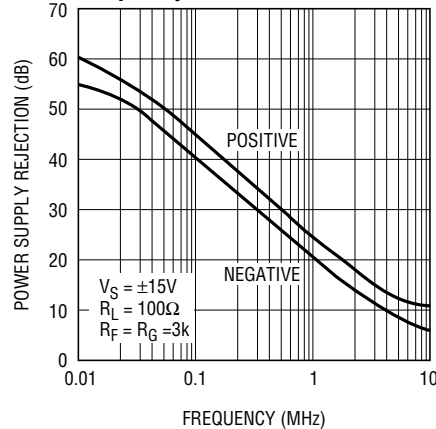

LT1217 • TPC17

**Output Impedance vs Frequency**

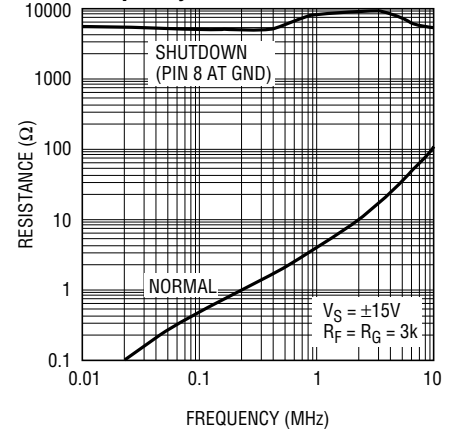

LT1217 • TPC18

## TYPICAL PERFORMANCE CHARACTERISTICS

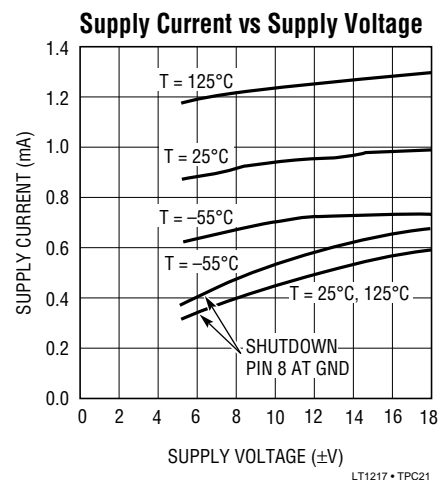
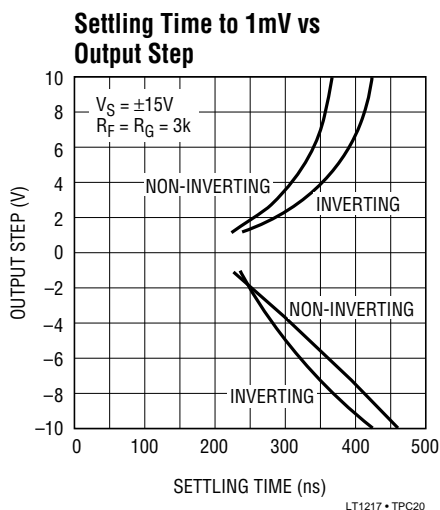
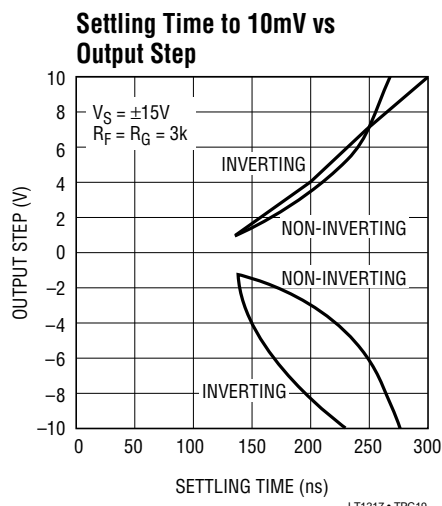

## APPLICATIONS INFORMATION

### Current Feedback Basics

The small signal bandwidth of the LT1217, like all current feedback amplifiers, isn't a straight inverse function of the closed loop gain. This is because the feedback resistors determine the amount of current driving the amplifier's internal compensation capacitor. In fact, the amplifier's feedback resistor ( $R_F$ ) from output to inverting input works with internal junction capacitances of the LT1217 to set the closed loop bandwidth.

Even though the gain set resistor ( $R_G$ ) from inverting input to ground works with  $R_F$  to set the voltage gain just like it does in a voltage feedback op amp, the closed loop bandwidth does not change. This is because the equivalent gain bandwidth product of the current feedback amplifier is set by the Thevenin equivalent resistance at the inverting input and the internal compensation capacitor. By keeping  $R_F$  constant and changing the gain with  $R_G$ , the Thevenin resistance changes by the same amount as the change in gain. As a result, the net closed loop bandwidth of the LT1217 remains the same for various closed loop gains.

The curve on the first page shows the LT1217 voltage gain versus frequency while driving  $100\Omega$ , for five gain settings from 1 to 100. The feedback resistor is a constant  $3k$  and the gain resistor is varied from infinity to  $30\Omega$ . Second order effects reduce the bandwidth somewhat at the higher gain settings.

### Feedback Resistor Selection

The small signal bandwidth of the LT1217 is set by the external feedback resistors and the internal junction capacitors. As a result, the bandwidth is a function of the supply voltage, the value of the feedback resistor, the closed loop gain and load resistor. The characteristic curves of bandwidth versus supply voltage are done with a heavy load ( $100\Omega$ ) and a light load ( $1k\Omega$ ) to show the effect of loading. These graphs also show the family of curves that result from various values of the feedback resistor. These curves use a solid line when the response has less than  $0.5dB$  of peaking and a dashed line when the response has  $0.5dB$  to  $5dB$  of peaking. The curves stop where the response has more than  $5dB$  of peaking.

At a gain of two, on  $\pm 15V$  supplies with a  $3k\Omega$  feedback resistor, the bandwidth into a light load is  $13.5MHz$  with a little peaking, but into a heavy load the bandwidth is  $10MHz$  with no peaking. At very high closed loop gains, the bandwidth is limited by the gain bandwidth product of about  $100MHz$ . The curves show that the bandwidth at a closed loop gain of 100 is about  $1MHz$ .

### Capacitance on the Inverting Input

Current feedback amplifiers want resistive feedback from the output to the inverting input for stable operation. Take

## APPLICATIONS INFORMATION

care to minimize the stray capacitance between the output and the inverting input. Capacitance on the inverting input to ground will cause peaking in the frequency response (and overshoot in the transient response), but it does not degrade the stability of the amplifier. The amount of capacitance that is necessary to cause peaking is a function of the closed loop gain taken.

The higher the gain, the more capacitance is required to cause peaking. We can add capacitance from the inverting input to ground to increase the bandwidth in high gain applications. For example, in this gain of 100 application, the bandwidth can be increased from 1MHz to 2MHz by adding a 2200pF capacitor.

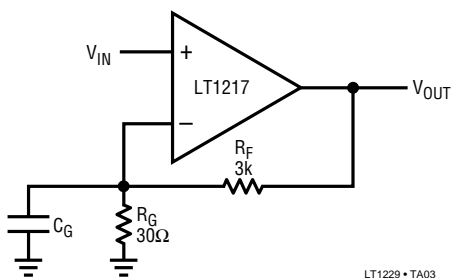

**Boosting Bandwidth of High Gain Amplifier with Capacitance on Inverting Input**

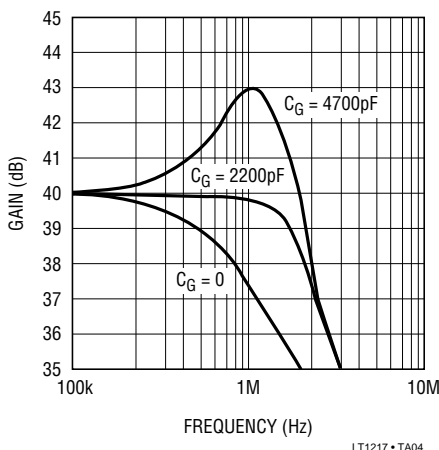

### Capacitive Loads

The LT1217 can be isolated from capacitive loads with a small resistor (10Ω to 20Ω) or it can drive the capacitive load directly if the feedback resistor is increased. Both techniques lower the amplifier’s bandwidth about the

same amount. The advantage of resistive isolation is that the bandwidth is only reduced when the capacitive load is present. The disadvantage of resistor isolation is that resistive loading causes gain errors. Because the DC accuracy is not degraded with resistive loading, the desired way of driving capacitive loads, such as flash converters, is to increase the feedback resistor. The Maximum Capacitive Load versus Feedback Resistor curve shows the value of feedback resistor and capacitive load that gives 5dB of peaking. For less peaking, use a larger feedback resistor.

### Power Supplies

The LT1217 may be operated with single or split supplies as low as ±4.5V (9V total) to as high as ±18V (36V total). It is not necessary to use equal value split supplies, however, the offset voltage will degrade about 350μV per volt of mismatch. The internal compensation capacitor decreases with increasing supply voltage. The –3dB Bandwidth versus Supply Voltage curves show how this affects the bandwidth for various feedback resistors. Generally, the bandwidth at ±5V supplies is about half the value it is at ±15V supplies for a given feedback resistor.

The LT1217 is very stable even with minimal supply bypassing, however, the transient response will suffer if the supply rings. It is recommended for good slew rate and settling time that 4.7μF tantalum capacitors be placed within 0.5 inches of the supply pins.

### Input Range

The non-inverting input of the LT1217 looks like a 100MΩ resistor in parallel with a 3pF capacitor until the common mode range is exceeded. The input impedance drops somewhat and the input current rises to about 10μA when the input comes too close to the supplies. Eventually, when the input exceeds the supply by one diode drop, the base collector junction of the input transistor forward biases and the input current rises dramatically. The input current should be limited to 10mA when exceeding the supplies. The amplifier will recover quickly when the input is returned to its normal common mode range unless the input was over 500mV beyond the supplies, then it will take an extra 100ns.

## APPLICATIONS INFORMATION

### Offset Adjust

Output offset voltage is equal to the input offset voltage times the gain plus the inverting input bias current times the feedback resistor. The LT1217 output offset voltage can be nulled by pulling approximately  $30\mu\text{A}$  from pin 1 or 5. The easy way to do this is to use a  $100\text{k}\Omega$  pot between pin 1 and 5 with a  $430\text{k}\Omega$  resistor from the wiper to ground for 15V supply applications. Use a  $110\text{k}$  resistor when operating on a 5V supply.

### Shutdown

Pin 8 activates a shutdown control function. Pulling more than  $50\mu\text{A}$  from pin 8 drops the supply current to less than  $350\mu\text{A}$ , and puts the output into a high impedance state. The easy way to force shutdown is to ground pin 8, using an open collector (drain) logic stage. An internal resistor limits current, allowing direct interfacing with no additional parts. When pin 8 is open, the LT1217 operates normally.

### Slew Rate

The slew rate of a current feedback amplifier is not independent of the amplifier gain configuration the way it is in a traditional op amp. This is because the input stage and the output stage both have slew rate limitations. Inverting amplifiers do not slew the input and are therefore limited only by the output stage. High gain, non-inverting amplifiers are similar. The input stage slew rate of the LT1217 is about  $50\text{V}/\mu\text{s}$  before it becomes non-linear and is enhanced by the normally reverse biased emitters on the input transistors. The output slew rate depends on the size of the feedback resistors. The output slew rate is about  $850\text{V}/\mu\text{s}$  with a  $3\text{k}$  feedback resistor and drops proportionally for larger values. The photos show the LT1217 with a  $20\text{V}$  peak-to-peak output swing for three different gain configurations.

### Settling Time

The characteristic curves show that the LT1217 settles to within  $10\text{mV}$  of final value in less than  $300\text{ns}$  for any output step up to  $10\text{V}$ . Settling to  $1\text{mV}$  of final value takes less than  $500\text{ns}$ .

Large Signal Response,  $A_V = 2$ ,  $R_F = R_G = 3\text{k}$ ,  
Slew Rate  $\approx 500\text{V}/\mu\text{s}$

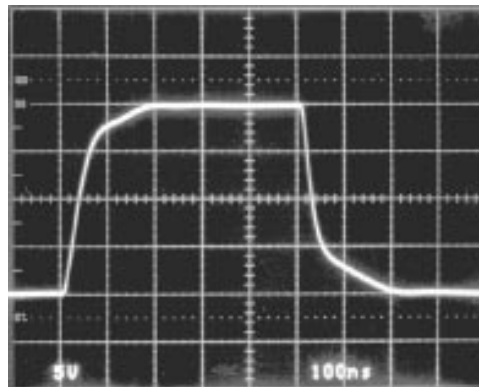

Large Signal Response,  $A_V = -2$ ,  $R_F = 3\text{k}$ ,  $R_G = 1.5\text{k}$ ,  
Slew Rate  $\approx 850\text{V}/\mu\text{s}$

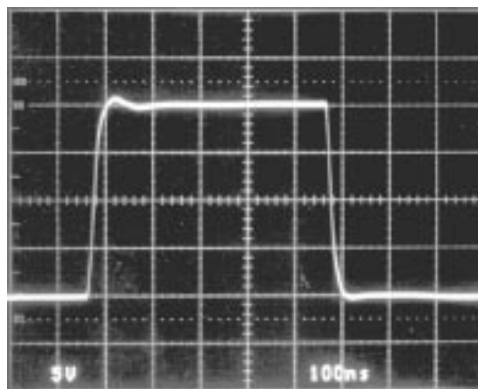

Large Signal Response,  $A_V = 10$ ,  $R_F = 3\text{k}$ ,  $R_G = 330\Omega$ ,  
Slew Rate  $\approx 150\text{V}/\mu\text{s}$

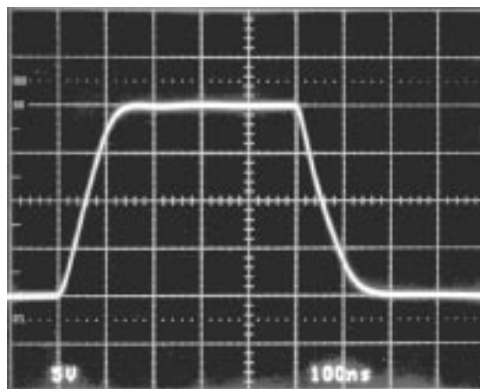

# SIMPLIFIED SCHEMATIC

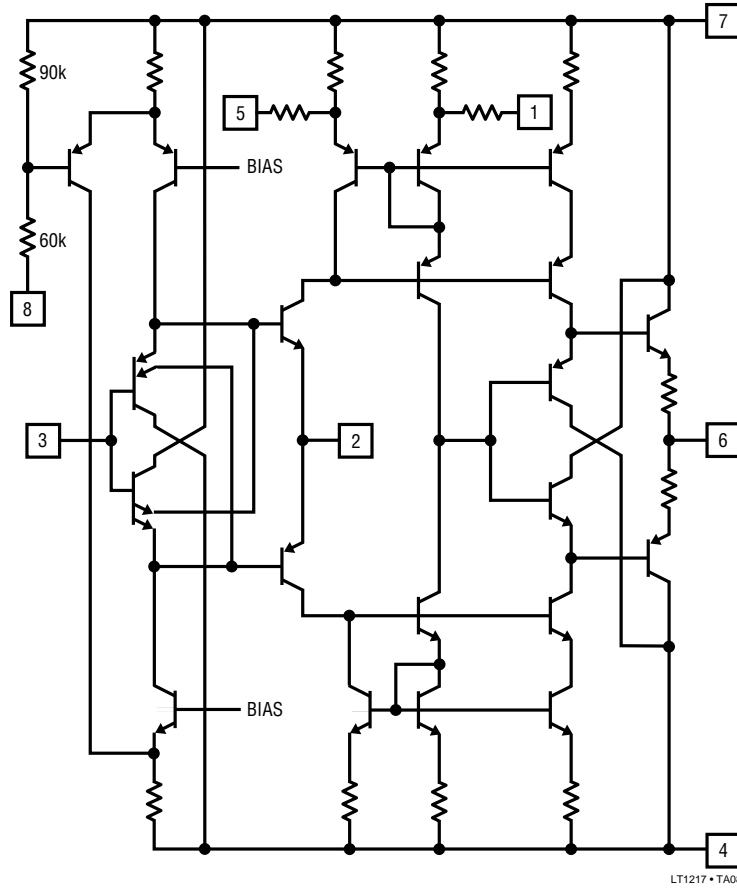

# PACKAGE DESCRIPTION

Dimensions in inches (millimeters) unless otherwise noted.

## N8 Package 8-Lead Plastic DIP

|           |               |
|-----------|---------------|
| $T_J$ MAX | $\theta_{JA}$ |
| 150°C     | 100°C/W       |

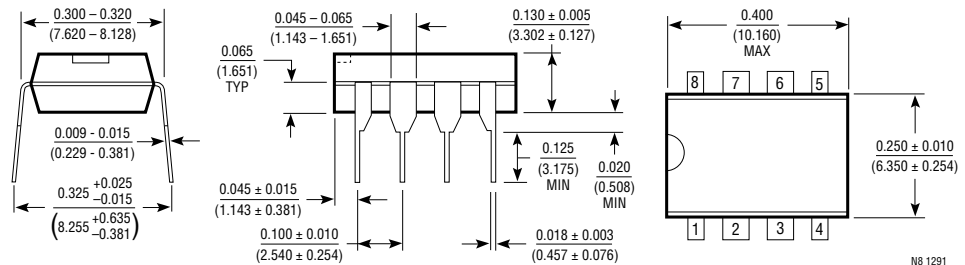

N8 1291

## S8 Package 8-Lead Plastic SOIC

|           |               |
|-----------|---------------|
| $T_J$ MAX | $\theta_{JA}$ |
| 150°C     | 150°C/W       |

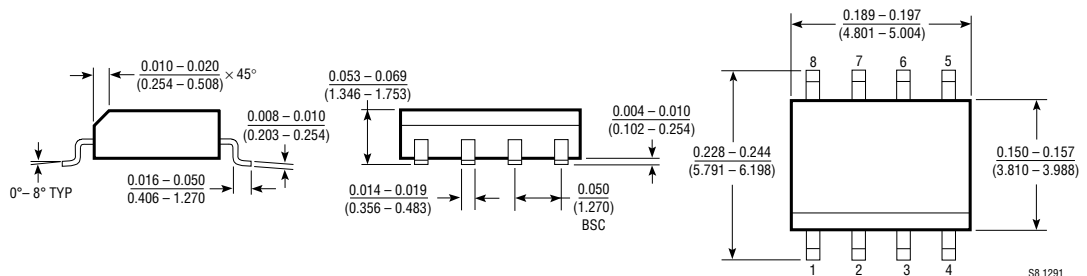

S8 1291