

Ordering Information

Part Number	Voltage	Temperature Range	Package	Lead Finish
MIC2182BM	Adjustable	-40°C to +85°C	16-pin narrow SOP	Standard
MIC2182-3.3BM	3.3V	-40°C to +85°C	16-pin narrow SOP	Standard
MIC2182-5.0BM	5.0V	-40°C to +85°C	16-pin narrow SOP	Standard
MIC2182BSM	Adjustable	-40°C to +85°C	16-pin narrow SSOP	Standard
MIC2182-3.3BSM	3.3V	-40°C to +85°C	16-pin narrow SSOP	Standard
MIC2182-5.0BSM	5.0V	-40°C to +85°C	16-pin narrow SSOP	Standard
MIC2182YM	Adjustable	-40°C to +85°C	16-pin narrow SOP	Pb-Free
MIC2182-3.3YM	3.3V	-40°C to +85°C	16-pin narrow SOP	Pb-Free
MIC2182-5.0YM	5.0V	-40°C to +85°C	16-pin narrow SOP	Pb-Free
MIC2182YSM	Adjustable	-40°C to +85°C	16-pin narrow SSOP	Pb-Free
MIC2182-3.3YSM	3.3V	-40°C to +85°C	16-pin narrow SSOP	Pb-Free
MIC2182-5.0YSM	5.0V	-40°C to +85°C	16-pin narrow SSOP	Pb-Free

Pin Configuration

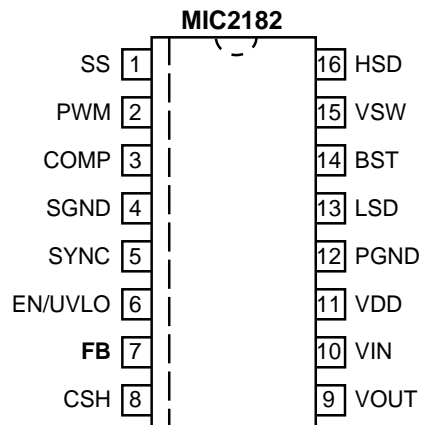

Adjustable
16-pin SOP (M)
16-Pin SSOP (SM)

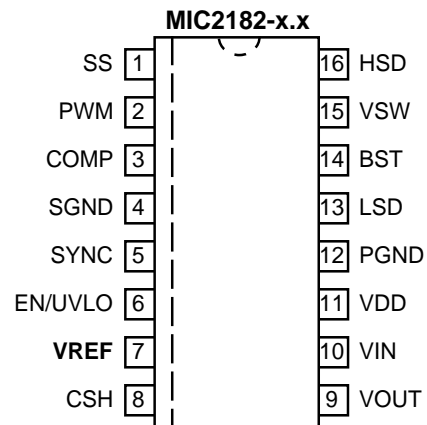

Fixed
16-pin SOP (M)
16-Pin SSOP (SM)

Pin Description

Pin Number	Pin Name	Pin Function
1	SS	Soft-Start (External Component): Connect external capacitor to ground to reduce inrush current by delaying and slowing the output voltage rise time. Rise time is controlled by an internal 5 μ A current source that charges an external capacitor to V_{DD} .
2	PWM	PWM/Skip-Mode Select (Input): Low sets PWM-mode operation. 1nF capacitor to ground sets automatic PWM/skip-mode selection.
3	COMP	Compensation (Output): Internal error amplifier output. Connect to capacitor or series RC network to compensate the regulator control loop.
4	SGND	Small Signal Ground (Return): Route separately from other ground traces to the (-) terminal of C_{OUT} .
5	SYNC	Frequency Synchronization (Input): Optional. Connect to external clock signal to synchronize the oscillator. Leading edge of signal above the threshold terminates the switching cycle. Connect to SGND if unused.
6	EN/UVLO	Enable/Undervoltage Lockout (Input): Low-level signal powers down the controller. Input below the 2.5V threshold disables switching and functions as an accurate undervoltage lockout (UVLO). Input below the threshold forces complete micropower (< 0.1 μ A) shutdown.
7 (fixed)	VREF	Reference Voltage (Output): 1.245V output. Requires 0.1 μ F capacitor to ground.
7 (adj)	FB	Feedback (Input): Regulates FB pin to 1.245V. See "Application Information" for resistor divider calculations.
8	CSH	Current-Sense High (Input): Current-limit comparator noninverting input. A built-in offset of 100mV between CSH and V_{OUT} pins in conjunction with the current-sense resistor set the current-limit threshold level. This is also the positive input to the current sense amplifier.
9	VOUT	Current-Sense Low (Input): Output voltage feedback input and inverting input for the current limit comparator and the current sense amplifier.
10	VIN	[Battery] Unregulated Input (Input): +4.5V to +32V supply input.
11	VDD	5V Internal Linear-Regulator (Output): V_{DD} is the external MOSFET gate drive supply voltage and an internal supply bus for the IC. Bypass to SGND with 4.7 μ F. V_{DD} can supply up to 5mA for external loads.
12	PGND	MOSFET Driver Power Ground (Return): Connects to source of synchronous MOSFET and the (-) terminal of C_{IN} .
13	LSD	Low-Side Drive (Output): High-current driver output for external synchronous MOSFET. Voltage swing is between ground and V_{DD} .
14	BST	Boost (Input): Provides drive voltage for the high-side MOSFET driver. The drive voltage is higher than the input voltage by V_{DD} minus a diode drop.
15	VSW	Switch (Return): High-side MOSFET driver return.
16	HSD	High-Side Drive (Output): High-current driver output for high-side MOSFET. This node voltage swing is between ground and $V_{IN} + 5V - V_{diode\ drop}$.

Absolute Maximum Ratings (Note 1)

Analog Supply Voltage (V_{IN})	+34V
Digital Supply Voltage (V_{DD})	+7V
Driver Supply Voltage (B_{ST})	$V_{IN} + 7V$
Sense Voltage (V_{OUT} , C_{SH})	7V to -0.3V
Sync Pin Voltage (V_{SYNC})	7V to -0.3V
Enable Pin Voltage ($V_{EN/UVLO}$)	V_{IN}
Power Dissipation (P_D)	
SOP	400mW @ $T_A = 85^\circ\text{C}$
SSOP	270mW @ $T_A = 85^\circ\text{C}$
Ambient Storage Temperature (T_S)	-65°C to +150°C

ESD, Note 3**Electrical Characteristics**

$V_{IN} = 15V$; SS = open; $V_{PWM} = 0V$; $V_{SHDN} = 5V$; $I_{LOAD} = 0.1A$; $T_A = 25^\circ\text{C}$, **bold** values indicate $-40^\circ\text{C} \leq T_A \leq +85^\circ\text{C}$; **Note 4**; unless noted

Parameter	Condition	Min	Typ	Max	Units
MIC2182 [Adjustable], (Note 5)					
Feedback Voltage Reference		1.233	1.245	1.257	V
Feedback Voltage Reference		1.220	1.245	1.270	V
Feedback Voltage Reference	$4.5V < V_{IN} < 32V$, $0 < V_{CSH} - V_{OUT} < 75mV$	1.208	1.245	1.282	V
Feedback Bias Current			10		nA
Output Voltage Range		1.25		6	V
Output Voltage Line Regulation	$V_{IN} = 4.5V$ to 32V, $V_{CSH} - V_{OUT} = 50mV$		0.03		%/V
Output Voltage Load Regulation	$25mV < (V_{CSH} - V_{OUT}) < 75mV$ (PWM mode only)		0.5		%
Output Voltage Total Regulation	$0mV < (V_{CSH} - V_{OUT}) < 75mV$ (full load range) $4.5V < V_{IN} < 32V$		0.6		%

MIC2182-3.3

Output Voltage		3.267	3.3	3.333	V
Output Voltage		3.234	3.3	3.366	V
Output Voltage	$4.5V < V_{IN} < 32V$, $0 < V_{CSH} - V_{OUT} < 75mV$	3.201	3.3	3.399	V
Output Voltage Line Regulation	$V_{IN} = 4.5V$ to 32V, $V_{CSH} - V_{OUT} = 50mV$		0.03		%/V
Output Voltage Load Regulation	$25mV < (V_{CSH} - V_{OUT}) < 75mV$ (PWM mode only)		0.5		%
Output Voltage Total Regulation	$0mV < (V_{CSH} - V_{OUT}) < 75mV$ (full load range) $4.5V < V_{IN} < 32V$		0.8		%

MIC2182-5.0

Output Voltage		4.95	5.0	5.05	V
Output Voltage		4.90	5.0	5.10	V
Output Voltage	$6.5V < V_{IN} < 32V$, $0 < V_{CSH} - V_{OUT} < 75mV$	4.85	5.0	5.150	V
Output Voltage Line Regulation	$V_{IN} = 6.5V$ to 32V, $V_{CSH} - V_{OUT} = 50mV$		0.03		%/V
Output Voltage Load Regulation	$25mV < (V_{CSH} - V_{OUT}) < 75mV$ (PWM mode only)		0.5		%
Output Voltage Total Regulation	$0mV < (V_{CSH} - V_{OUT}) < 75mV$ (full load range) $6.5V < V_{IN} < 32V$		0.8		%

Input and VDD Supply

PWM Mode	$V_{PWM} = 0V$, excluding external MOSFET gate drive current		1.6	2.5	mA
Skip Mode	$I_L = 0mA$, V_{PWM} floating (1nF capacitor to ground)		600	1500	μA
Shutdown Quiescent Current	$V_{EN/UVLO} = 0V$		0.1	5	μA
Digital Supply Voltage (V_{DD})	$I_L = 0mA$ to 5mA	4.7		5.3	V
Undervoltage Lockout	V_{DD} upper threshold (turn on threshold)		4.2		V
	V_{DD} lower threshold (turn off threshold)		4.1		V

Parameter	Condition	Min	Typ	Max	Units
Reference Output (Fixed Versions Only)					
Reference Voltage		1.220	1.245	1.270	V
Reference Line Regulation	$6V < V_{IN} < 32V$		1		mV
Reference Load Regulation	$0\mu A < I_{REF} < 100\mu A$		2		mV
Enable/UVLO					
Enable Input Threshold		0.6	1.1	1.6	V
UVLO Threshold		2.2	2.5	2.8	V
Enable Input Current	$V_{EN/UVLO} = 5V$		0.1	5	μA
Soft Start					
Soft-Start Current	$V_{SS} = 0V$	-3.5	-5	-6.5	μA
Current Limit					
Current-Limit Threshold Voltage	$V_{CSH} = V_{OUT}$	75	100	135	mV
Error Amplifier					
Error Sense Amplifier Gain			20		
Current Amp					
Current Sense Amplifier Gain			2.0		
Oscillator Section					
Oscillator Frequency		270	300	330	kHz
Maximum Duty Cycle			86		%
Minimum On-Time	$V_{OUT} = V_{OUT(nominal)} + 200mV$		140	250	ns
SYNC Threshold Level		0.7	1.3	1.9	V
SYNC Input Current	$V_{SYNC} = 5V$		0.1	5	μA
SYNC Minimum Pulse Width		200			ns
SYNC Capture Range	Note 6	330			kHz
Frequency Foldback Threshold	measured at VOUT pin	0.75	0.95	1.15	V
Foldback Frequency			60		kHz
Gate Drivers					
Rise/Fall Time	$C_L = 3000pF$		60		ns
Output Driver Impedance	source sink		5 3.5	8.5 6	Ω Ω
Driver Nonoverlap Time			80		ns
PWM Input					
PWM Input Current	$V_{PWM} = 0V$		-10		μA

Note 1. Exceeding the absolute maximum rating may damage the device.

Note 2. The device is not guaranteed to function outside its operating rating.

Note 3. Devices are ESD sensitive. Handling precautions recommended. Human body model, 1.5k in series with 100pF.

Note 4. 25°C limits are 100% production tested. Limits over the operating temperature range are guaranteed by design and are not production tested.

Note 5. $V_{IN} > 1.3 \times V_{OUT}$ (for the feedback voltage reference and output voltage line and total regulation).

Note 6. See applications information for limitations on the maximum operating frequency.

Typical Characteristics

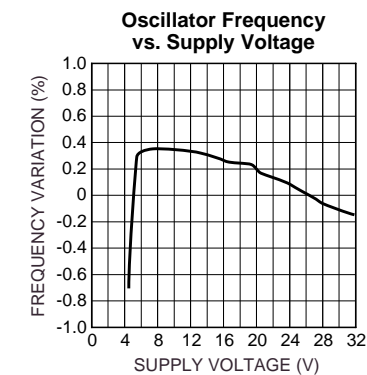
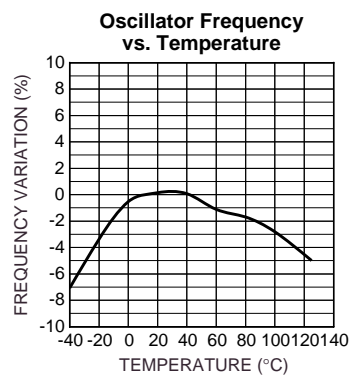
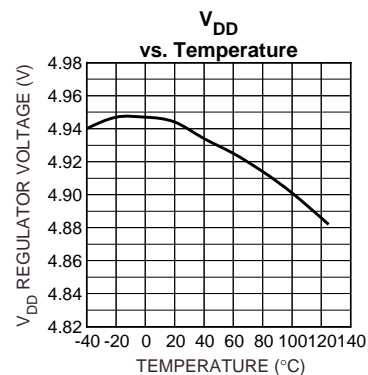
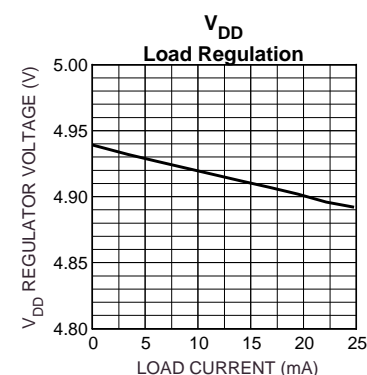
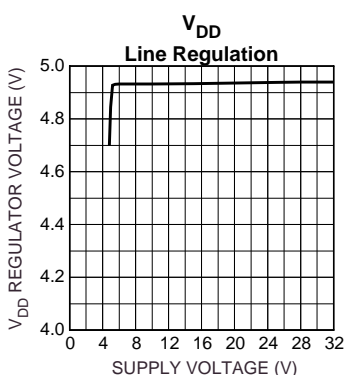
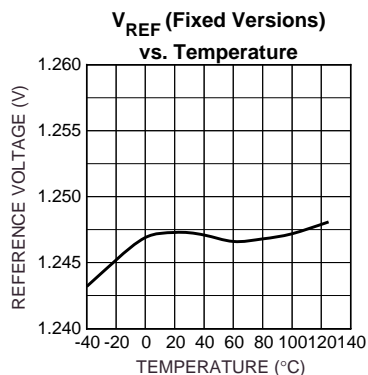
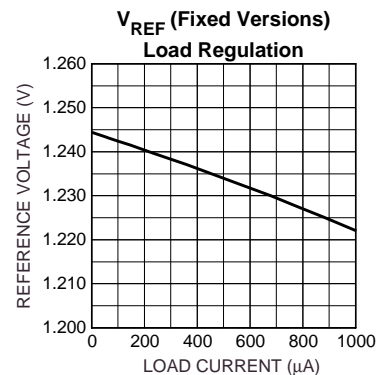
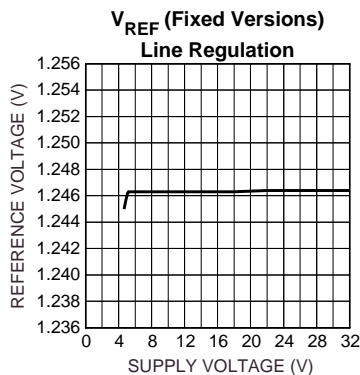
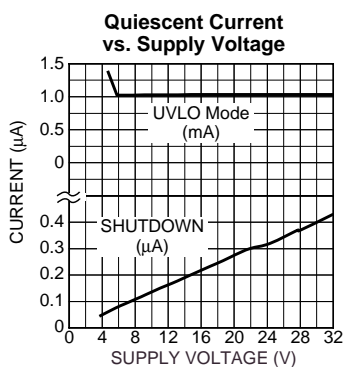
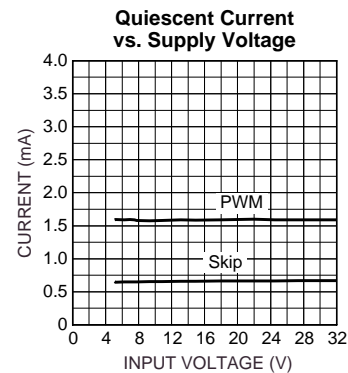
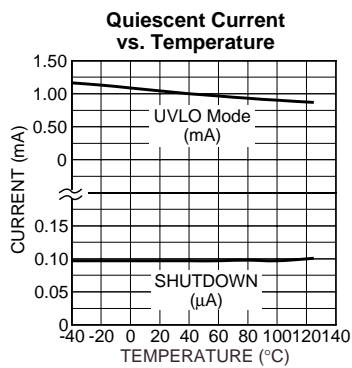
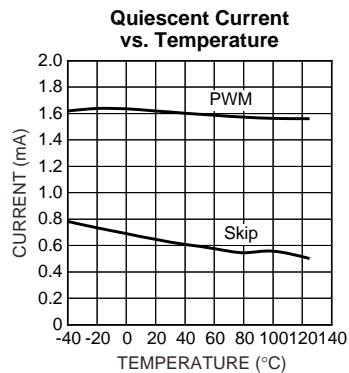

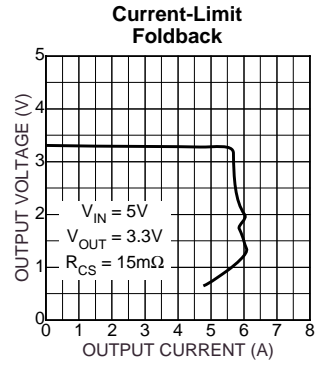
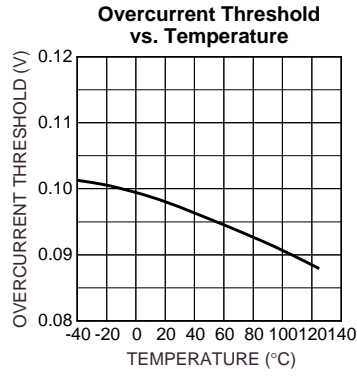
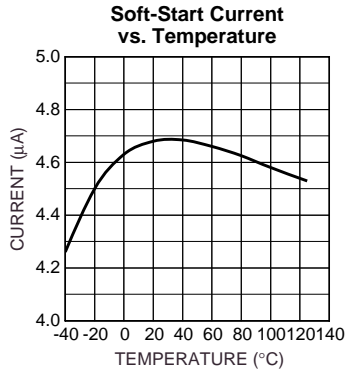

Block Diagrams

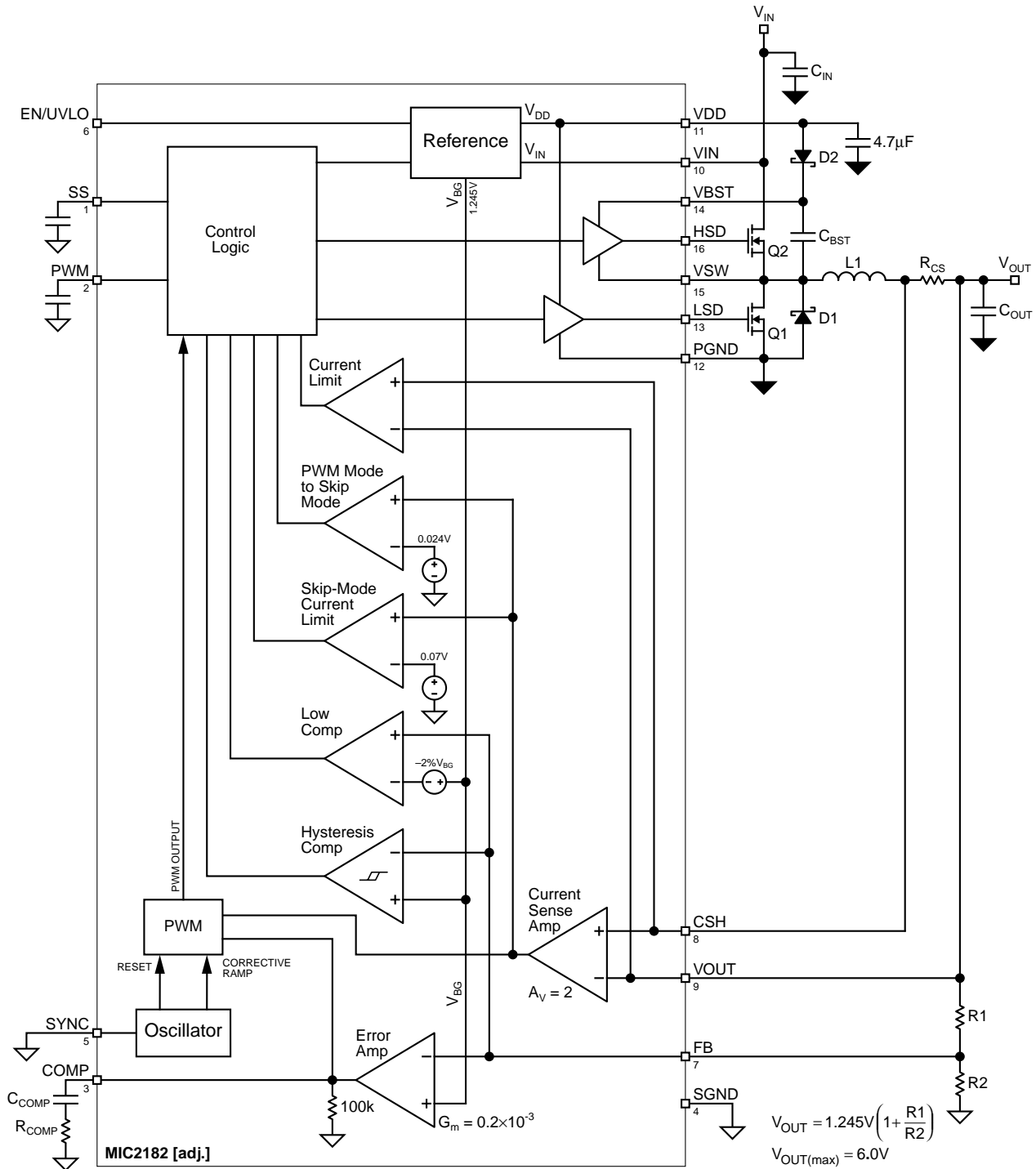

Figure 2a. Adjustable Output Voltage Version

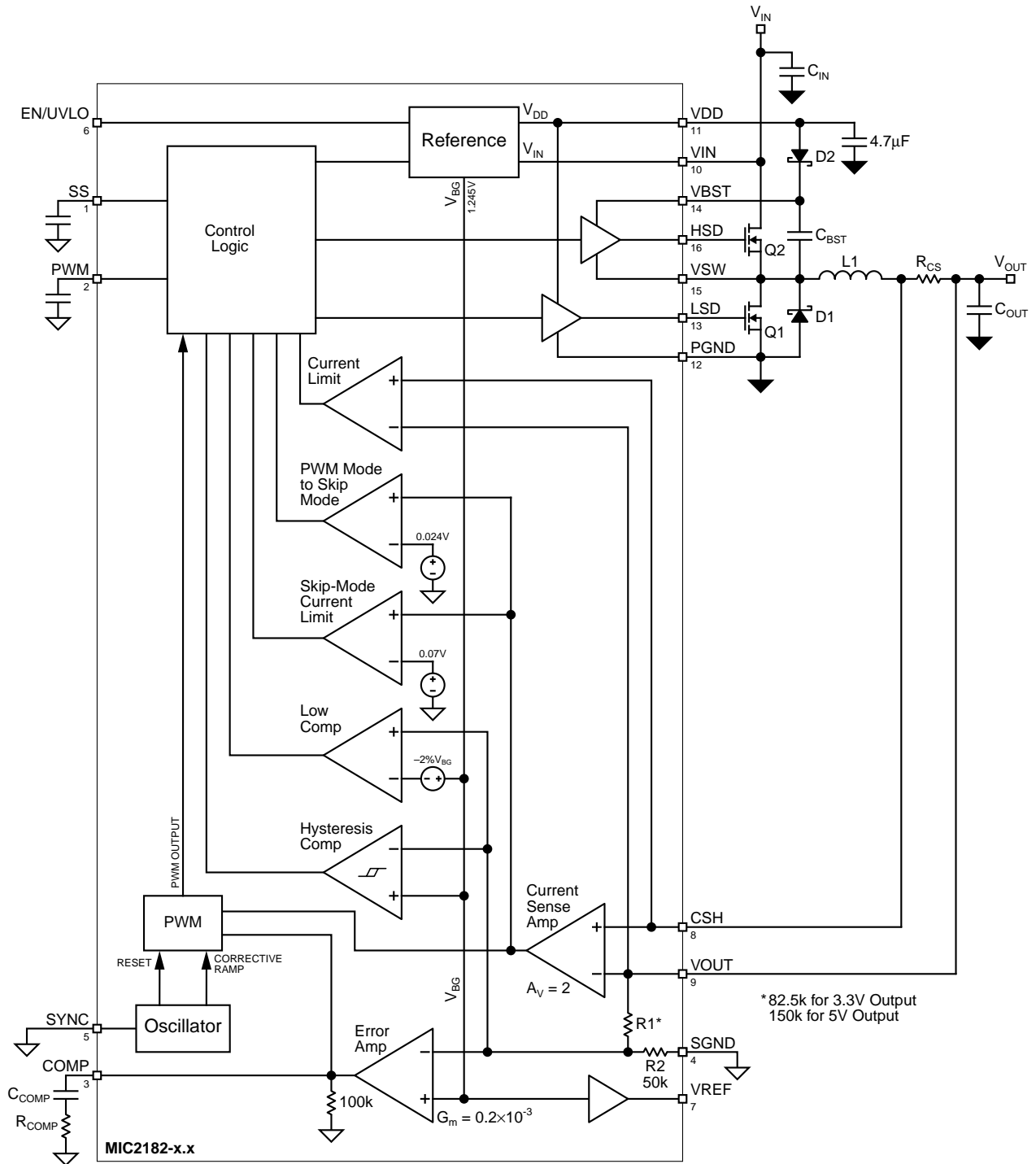

Figure 2b. Fixed Output Voltage Versions

Functional Description

See “Applications Information” following this section for component selection information and Figure 14 and Tables 1 through 5 for predesigned circuits.

The MIC2182 is a BiCMOS, switched-mode, synchronous step-down (buck) converter controller. Current-mode control is used to achieve superior transient line and load regulation. An internal corrective ramp provides slope compensation for stable operation above a 50% duty cycle. The controller is optimized for high-efficiency, high-performance dc-dc converter applications.

The MIC2182 block diagrams are shown in Figure 2a and Figure 2b.

The MIC2182 controller is divided into 6 functions.

- Control loop
 - PWM operation
 - Skip-mode operation
- Current limit
- Reference, enable, and UVLO
- MOSFET gate drive
- Oscillator and sync
- Soft start

Control Loop

PWM and Skip Modes of Operation

The MIC2182 operates in PWM (pulse-width-modulation) mode at heavier output load conditions. At lighter load conditions, the controller can be configured to automatically switch to a pulse-skipping mode to improve efficiency. The potential disadvantage of skip mode is the variable switching frequency that accompanies this mode of operation. The occurrence of switching pulses depends on component values as well as line and load conditions. There is an external sync function that is disabled in skip mode. In PWM mode, the synchronous buck converter forces continuous current to flow in the inductor. In skip mode, current through the inductor can settle to zero, causing voltage ringing across the inductor. Pulling the PWM pin (pin 2) low will force the controller to operate in PWM mode for all load conditions, which will improve cross regulation of transformer-coupled, multiple output configurations.

PWM Control Loop

The MIC2182 uses current-mode control to regulate the output voltage. This method senses the output voltage (outer loop) and the inductor current (inner loop). It uses inductor current and output voltage to determine the duty cycle of the buck converter. Sampling the inductor current removes the inductor from the control loop, which simplifies compensation.

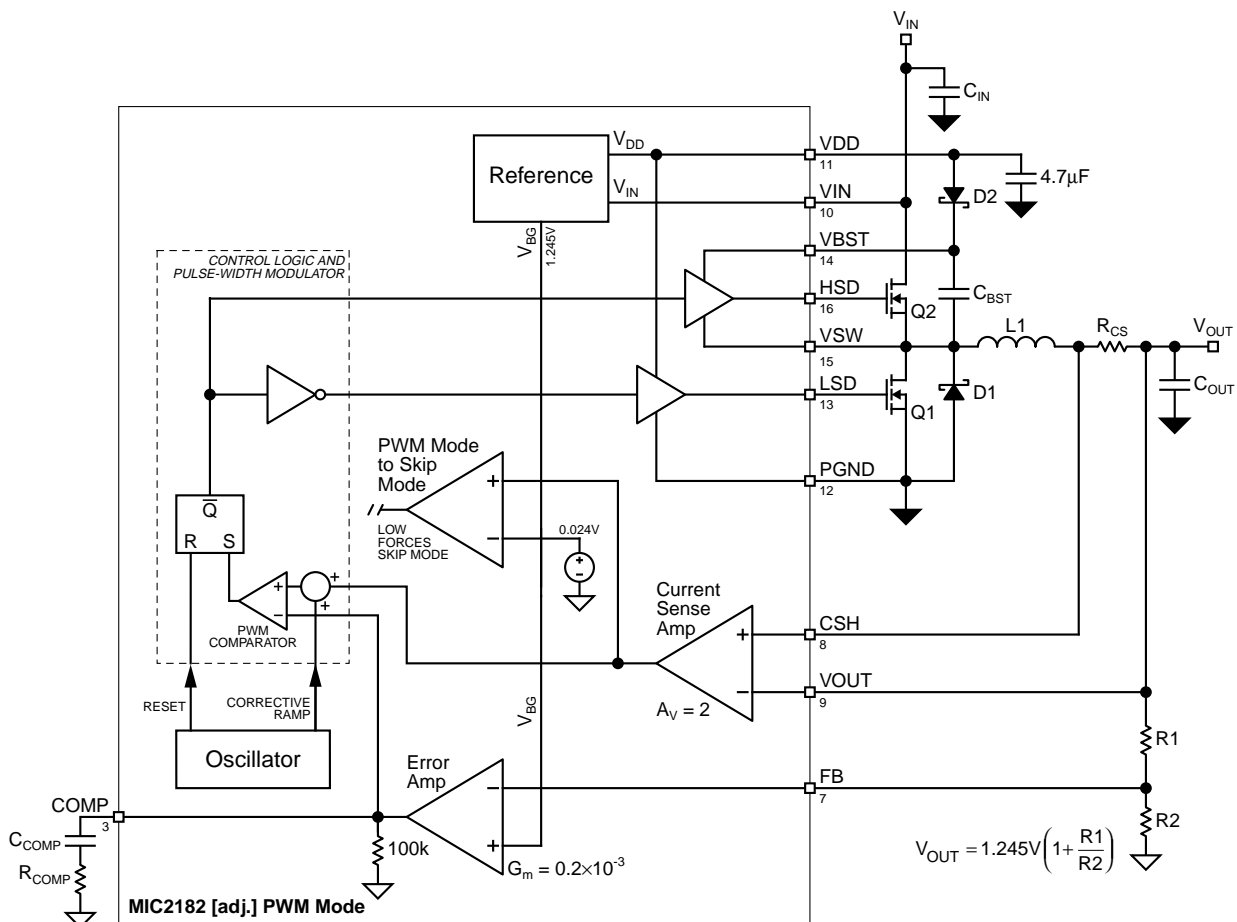

Figure 3. PWM Operation

A block diagram of the MIC2182 PWM current-mode control loop is shown in Figure 3 and the PWM mode voltage and current waveforms are shown in figure 5A. The inductor current is sensed by measuring the voltage across the resistor, R_{CS} . A ramp is added to the amplified current-sense signal to provide slope compensation, which is required to prevent unstable operation at duty cycles greater than 50%. A transconductance amplifier is used for the error amplifier, which compares an attenuated sample of the output voltage with a reference voltage. The output of the error amplifier is the COMP (compensation) pin, which is compared to the current-sense waveform in the PWM block. When the current signal becomes greater than the error signal, the comparator turns off the high-side drive. The COMP pin (pin 3) provides access to the output of the error amplifier and allows the use of external components to stabilize the voltage loop.

Skip-Mode Control Loop

This control method is used to improve efficiency at light output loads. At light output currents, the power drawn by the MIC2182 is equal to the input voltage times the IC supply current (I_Q). At light output currents, the power dissipated by the IC can be a significant portion of the total output power, which lowers the efficiency of the power supply. The MIC2182 draws less supply current in skip mode by disabling portions of the control and drive circuitry when the IC is not switching. The disadvantage of this method is greater output voltage ripple and variable switching frequency.

A block diagram of the MIC2182 skip mode is shown in Figure 4. Skip mode voltage and current waveforms are shown in figure 5B.

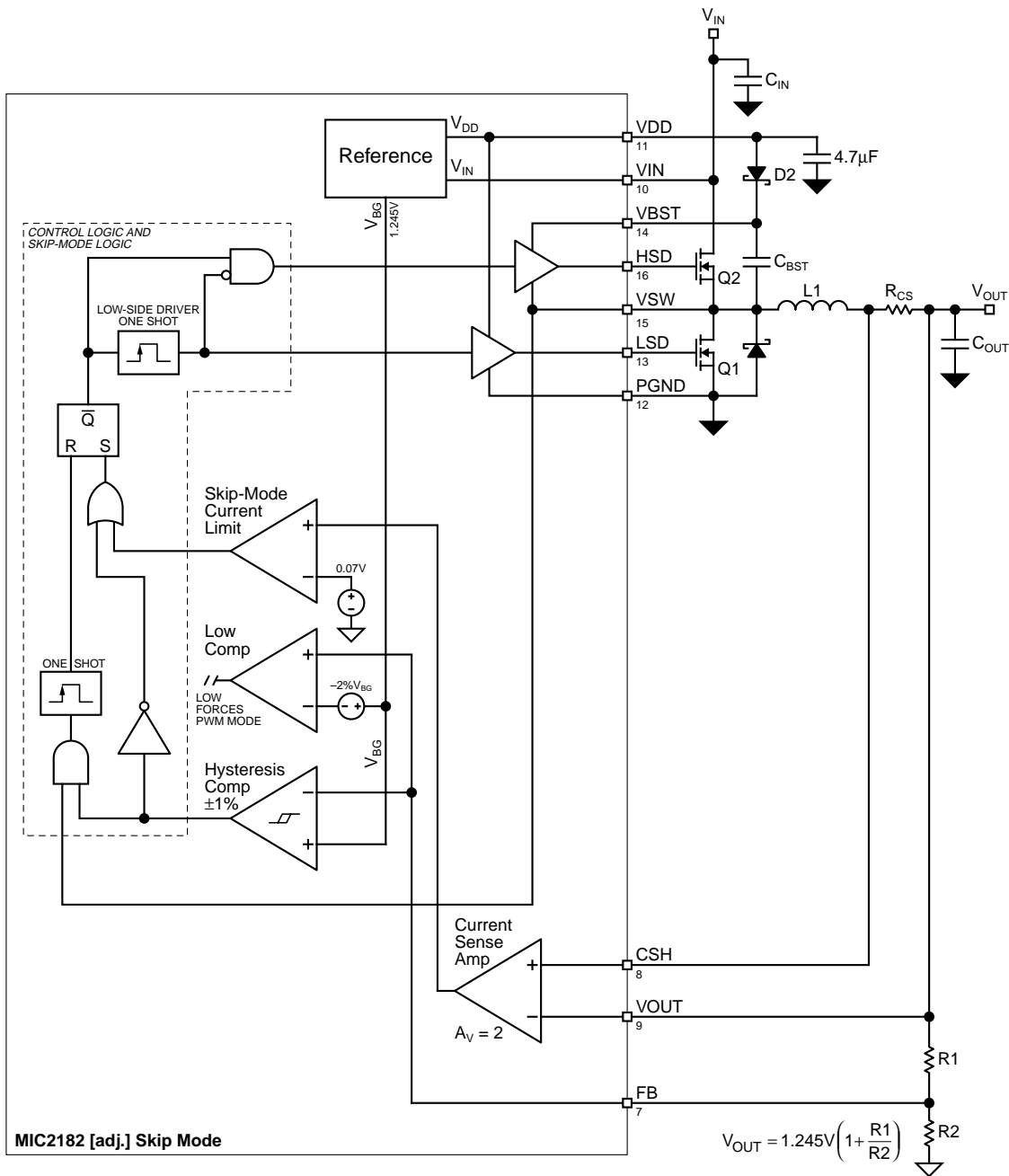

Figure 4. Skip-Mode Operation

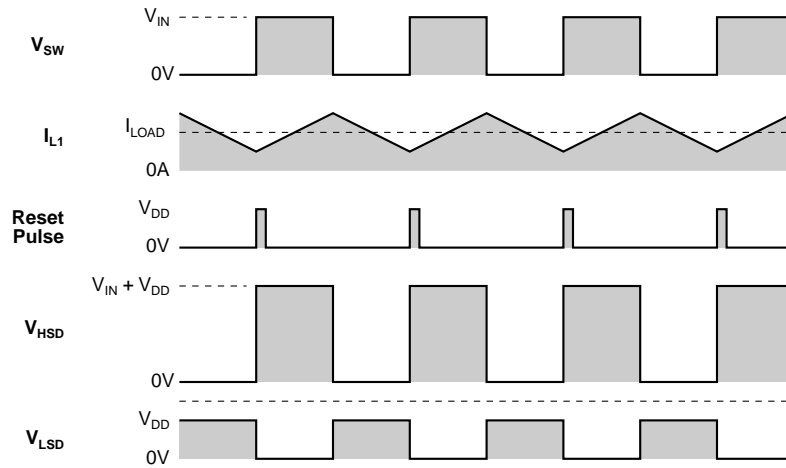

Figure 5a. PWM-Mode Timing

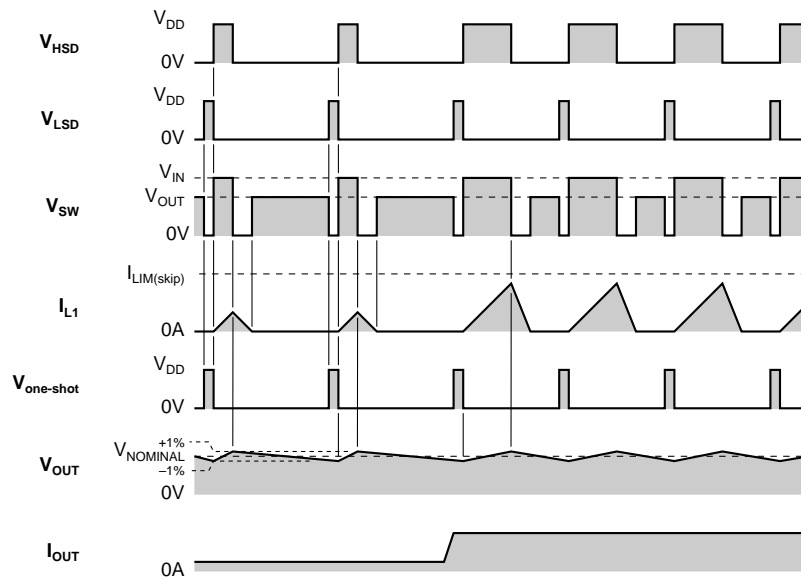

Figure 5b. Skip-Mode Timing

A hysteretic comparator is used in place of the PWM error amplifier and a current-limit comparator senses the inductor current. A one-shot starts the switching cycle by momentarily turning on the low side MOSFET to insure the high-side drive boost capacitor, C_{bst} , is fully charged. The high-side MOSFET is turned on and current ramps up in the inductor, L_1 . The high-side drive is turned off when either the peak voltage on the input of the current-sense comparator exceeds the threshold, typically 35mV, or the output voltage rises above the hysteretic threshold of the output voltage comparator. Once the high-side MOSFET is turned off, the load current discharges the output capacitor, causing V_{OUT} to fall. The cycle repeats when V_{OUT} falls below the lower threshold, -1%.

The maximum peak inductor current depends on the skip-mode current-limit threshold and the value of the current-sense resistor, R_{CS} .

$$I_{inductor(peak)} = \frac{35mV}{R_{sense}}$$

Figure 6 shows the improvement in efficiency that skip mode makes when at lower output currents.

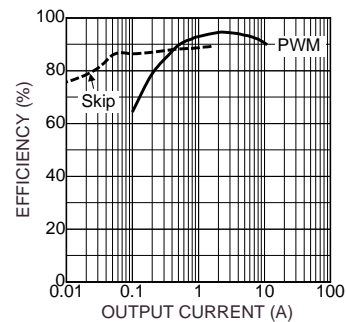

Figure 6. Efficiency

Switching from PWM to Skip Mode

The current sense amplifier in Figure 3 monitors the average voltage across the current-sense resistor. The controller will switch from PWM to skip mode when the average voltage across the current-sense resistor drops below approximately 12mV. This is shown in Figure 7b. The average output current at this transition level for is calculated below.

$$I_{OUT(\text{skip mode})} = \frac{0.012}{R_{CS}}$$

where:

0.012 = threshold voltage of the internal comparator

R_{CS} = current-sense resistor value

Switching from Skip to PWM Mode

The frequency of occurrence of the skip-mode current pulses increase as the output current increases until the hysteretic duty cycle reaches 100% (continuous pulses). Increasing the current past this point will cause the output voltage will drop. The low limit comparator senses the output voltage when it drops below 2% of the set output and automatically switches the converter to PWM mode.

The inductor current in skip mode is a triangular wave shape a minimum value of 0 and a maximum value of $35\text{mV}/R_{CS}$ (see Figure 7b). The maximum average output current in skip mode is the average value of the inductor waveform:

$$I_{OUT(\text{max skip mode})} = 0.5 \times \frac{35\text{mV}}{R_{CS}}$$

The capacitor on the PWM pin (pin 2) is discharged when the IC transitions from skip to PWM mode. This forces the IC to remain in PWM mode for a fixed period of time. The added delay prevents unwanted switching between PWM and skip mode. The capacitor is charged with a 10uA current source on pin 2. The threshold on pin 2 is 2.5V. The delay for a typical 1nF capacitor is:

$$t_{\text{delay}} = \frac{C_{\text{PWM}} \times V_{\text{threshold}}}{I_{\text{source}}} = \frac{1\text{nF} \times 2.5\text{V}}{10\mu\text{A}} = 250\mu\text{s}$$

where:

C_{PWM} = capacitor connected to pin 2

Current Limit

The current-limit circuit operates during PWM mode. The output current is detected by the voltage drop across the external current-sense resistor (R_{CS} in Figure 2.). The cur-

rent-limit threshold is $100\text{mV} + 35\text{mV} - 25\text{mV}$. The current-sense resistor must be sized using the minimum current-limit threshold. The external components must be designed to withstand the maximum current limit. The current-sense resistor value is calculated by the equation below:

$$R_{CS} = \frac{75\text{mV}}{I_{OUT(\text{max})}}$$

The maximum output current is:

$$I_{OUT(\text{max})} = \frac{135\text{mV}}{R_{CS}}$$

The current-sense pins CSH (pin 8) and V_{OUT} (pin 9) are noise sensitive due to the low signal level and high input impedance. The PCB traces should be short and routed close to each other. A small (1nF to 0.1uF) capacitor across the pins will attenuate high frequency switching noise.

When the peak inductor current exceeds the current-limit threshold, the current-limit comparator, in Figure 2, turns off the high-side MOSFET for the remainder of the cycle. The output voltage drops as additional load current is pulled from the converter. When the output voltage reaches approximately 0.95V, the circuit enters frequency-foldback mode and the oscillator frequency will drop to 60kHz while maintaining the peak inductor current equal to the nominal 100mV across the external current-sense resistor. This limits the maximum output power delivered to the load under a short circuit condition.

Reference, Enable, and UVLO Circuits

The output drivers are enabled when the following conditions are satisfied:

- The V_{DD} voltage (pin 11) is greater than its undervoltage threshold (typically 4.2V).
- The voltage on the enable pin is greater than the enable UVLO threshold (typically 2.5V)

The internal bias circuit generates a 1.245V bandgap reference voltage for the voltage error amplifier and a 5V V_{DD} voltage for the gate drive circuit. The reference voltage in the fixed-output-voltage versions of the MIC2182 is buffered and brought to pin 7. The V_{REF} pin should be bypassed to GND (pin 4) with a 0.1uF capacitor. The adjustable version of the MIC2182 uses pin 7 for output voltage sensing. A decoupling capacitor on pin 7 is not used in the adjustable output voltage version.

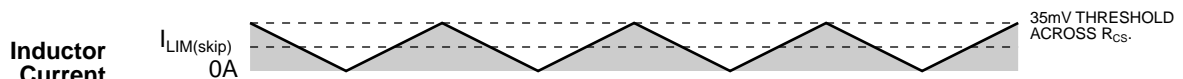

Figure 7a. Maximum Skip-Mode-Load Inductor Current

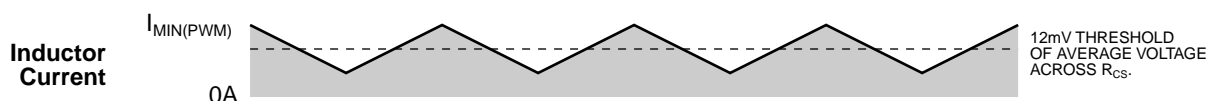

Figure 7b. Minimum PWM-Mode-Load Inductor Current for PWM Operation

The enable pin (pin 6) has two threshold levels, allowing the MIC2182 to shut down in a low current mode, or turn off output switching in UVLO mode. An enable pin voltage lower than the shutdown threshold turns off all the internal circuitry and reduces the input current to typically $0.1\mu\text{A}$.

If the enable pin voltage is between the shutdown and UVLO thresholds, the internal bias, V_{DD} , and reference voltages are turned on. The soft-start pin is forced low by an internal discharge MOSFET. The output drivers are inhibited from switching and remain in a low state. Raising the enable voltage above the UVLO threshold of 2.5V allows the soft-start capacitor to charge and enables the output drivers.

Either of two UVLO conditions will pull the soft-start capacitor low.

- When the V_{DD} drops below 4.1V
- When the enable pin drops below the 2.5V threshold

MOSFET Gate Drive

The MIC2182 high-side drive circuit is designed to switch an N-channel MOSFET. Referring to the block diagram in Figure 2, a bootstrap circuit, consisting of D2 and C_{BST} , supplies energy to the high-side drive circuit. Capacitor C_{BST} is charged while the low-side MOSFET is on and the voltage on the V_{SW} pin (pin 15) is approximately 0V . When the high-side MOSFET driver is turned on, energy from C_{BST} is used to turn the MOSFET on. As the MOSFET turns on, the voltage on the V_{SW} pin increases to approximately V_{IN} . Diode D2 is reversed biased and C_{BST} floats high while continuing to keep the high-side MOSFET on. When the low-side switch is turned back on, C_{BST} is recharged through D2.

The drive voltage is derived from the internal 5V V_{DD} bias supply. The nominal low-side gate drive voltage is 5V and the nominal high-side gate drive voltage is approximately 4.5V due to the voltage drop across D2. A fixed 80ns delay between the high- and low-side driver transitions is used to prevent current from simultaneously flowing unimpeded through both MOSFETs.

Oscillator and Sync

The internal oscillator is free running and requires no external components. The nominal oscillator frequency is 300kHz . If the output voltage is below approximately 0.95V , the oscillator operates in a frequency-foldback mode and the switching frequency is reduced to 60kHz .

The SYNC input (pin 5) allows the MIC2182 to synchronize with an external clock signal. The rising edge of the sync signal generates a reset signal in the oscillator, which turns off the low-side gate drive output. The high-side drive then turns on, restarting the switching cycle. The sync signal is inhibited when the controller operates in skip mode or during frequency foldback. The sync signal frequency must be greater than the maximum specified free running frequency of the MIC2182. If the synchronizing frequency is lower, double pulsing of the gate drive outputs will occur. When not used, the sync pin must be connected to ground.

Figure 8 shows the timing between the external sync signal (trace 2), the low-side drive (trace 1) and the high-side drive (trace R1). There is a delay of approximately 250ns between the rising edge of the external sync signal and turnoff of the low-side MOSFET gate drive.

Some concerns of operating at higher frequencies are:

- Higher power dissipation in the internal V_{DD} regulator. This occurs because the MOSFET gates require charge to turn on the device. The average current required by the MOSFET gate increases with switching frequency. This increases the power dissipated by the internal V_{DD} regulator. Figure 10 shows the total gate charge which can be driven by the MIC2182 over the input voltage range, for different values of switching frequency. The total gate charge includes both the high- and low-side MOSFETs. The larger SOP package is capable of dissipating more power than the SSOP package and can drive larger MOSFETs with higher gate drive requirements.

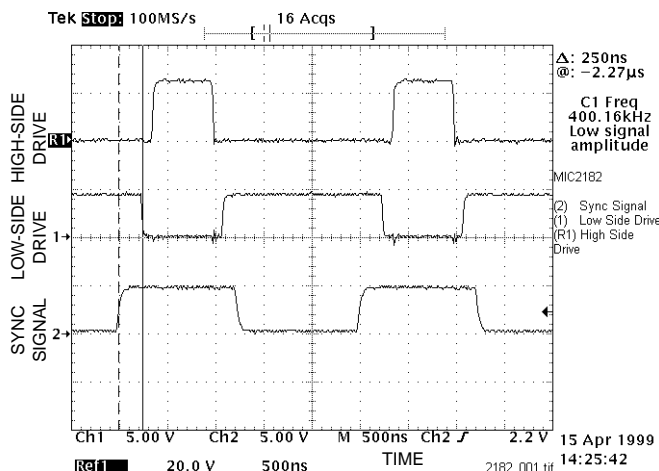

Figure 8. Sync Waveforms

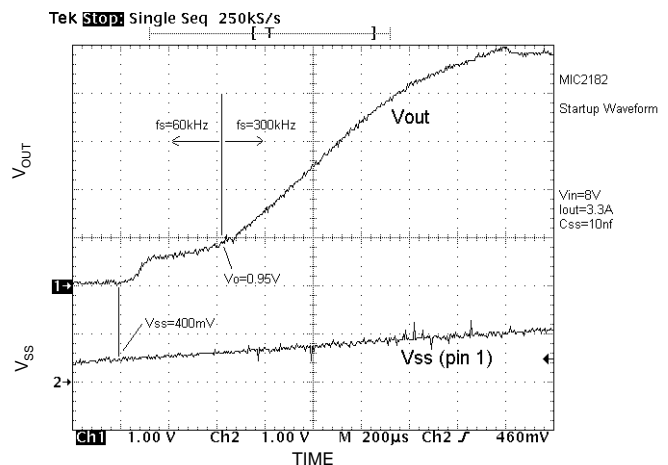

Figure 9. Startup Waveforms

- Reduced maximum duty cycle due to switching transition times and constant delay times in the controller. As the switching frequency increased, the switching period decreases. The switching transition times and constant delays in the MIC2182 start to become noticeable. The effect is to reduce the maximum duty cycle of the controller. This will cause the minimum input to output differential voltage (dropout voltage) to increase.

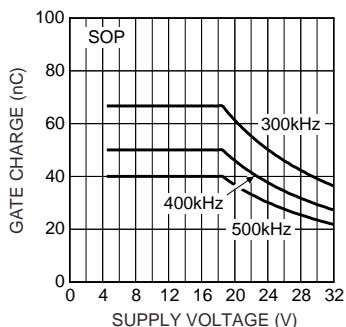

Figure 10a. SOP Gate Charge vs. Input Voltage

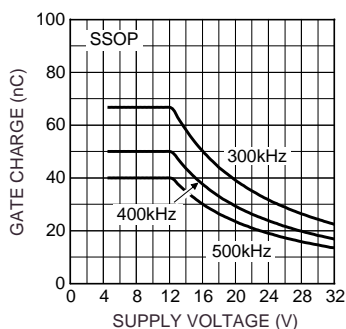

Figure 10b. SSOP Gate Charge vs. Input Voltage

It is recommended that the user limits the maximum synchronized frequency to 600kHz. If a higher synchronized frequency is required, it may be possible and will be design dependent. Please consult Micrel applications for assistance.

Soft Start

Soft start reduces the power supply input surge current at startup by controlling the output voltage rise time. The input surge appears while the output capacitance is charged up. A slower output rise time will draw a lower input surge current. Soft start may also be used for power supply sequencing.

The soft-start voltage is applied directly to the PWM comparator. A 5uA internal current source is used to charge up the soft-start capacitor. The capacitor is discharged when either the enable voltage drops below the UVLO threshold (2.5V) or the V_{DD} voltage drops below the UVLO level (4.1V).

The part switches at a minimum duty cycle when the soft-start pin voltage is less than 0.4V. This maintains a charge on the bootstrap capacitor and insures high-side gate drive voltage. As the soft-start voltage rises above 0.4V, the duty cycle increases from the minimum duty cycle to the operating duty cycle. The oscillator runs at the foldback frequency of 60kHz until the output voltage rises above 0.95V. Above 0.95V, the switching frequency increases to 300kHz (or the sync'd frequency), causing the output voltage to rise a greater rate. The rise time of the output is dependent on the soft-start capacitor, output capacitance, output voltage, and load current. The oscilloscope photo in Figure 9 show the output voltage and the soft-start pin voltage at startup.

Minimum Pulse Width

The MIC2182 has a specified minimum pulse width. This minimum pulse width places a lower limit on the minimum duty cycle of the buck converter. When the MIC2182 is operating in forced PWM mode (pin 2 low) and when the output current is very low or zero, there is a limit on the ratio of V_{OUT}/V_{IN} . If this limit is exceeded, the output voltage will rise above the regulated voltage level. A minimum load is required to prevent the output from rising up. This will not occur for output voltages greater than 3V.

Figure 11 should be used as a guide when the MIC2182 is forced into PWM-only mode. The actual maximum input voltage will depend on the exact external components used (MOSFETs, inductors, etc.).

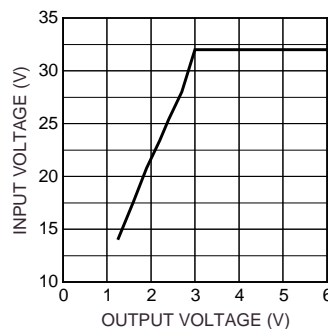

Figure 11. Max. Input Voltage in Forced-PWM Mode

This restriction does not occur when the MIC2182 is set to automatic mode (pin 2 connected to a capacitor) since the converter operates in skip mode at low output current.

Applications Information

The following applications information includes component selection and design guidelines. See Figure 14 and Tables 1 through 5 for predesigned circuits.

Inductor Selection

Values for inductance, peak, and RMS currents are required to select the output inductor. The input and output voltages and the inductance value determine the peak to peak inductor ripple current. Generally, higher inductance values are used with higher input voltages. Larger peak to peak ripple currents will increase the power dissipation in the inductor and MOSFETs. Larger output ripple currents will also require more output capacitance to smooth out the larger ripple current. Smaller peak to peak ripple currents require a larger inductance value and therefore a larger and more expensive inductor. A good compromise between size, loss and cost is to set the inductor ripple current to be equal to 20% of the maximum output current.

The inductance value is calculated by the equation below.

$$L = \frac{V_{OUT} \times (V_{IN(max)} - V_{OUT})}{V_{IN(max)} \times f_S \times 0.2 \times I_{OUT(max)}}$$

where:

f_S = switching frequency

0.2 = ratio of ac ripple current to dc output current

$V_{IN(max)}$ = maximum input voltage

The peak-to-peak inductor current (ac ripple current) is:

$$I_{PP} = \frac{V_{OUT} \times (V_{IN(max)} - V_{OUT})}{V_{IN(max)} \times f_S \times L}$$

The peak inductor current is equal to the average output current plus one half of the peak to peak inductor ripple current.

$$I_{PK} = I_{OUT(max)} + 0.5 \times I_{PP}$$

The RMS inductor current is used to calculate the $I^2 \cdot R$ losses in the inductor.

$$I_{inductor(rms)} = I_{OUT(max)} \times \sqrt{1 + \frac{1}{3} \left(\frac{I_{PP}}{I_{OUT(max)}} \right)^2}$$

Maximizing efficiency requires the proper selection of core material and minimizing the winding resistance. The high frequency operation of the MIC2182 requires the use of ferrite materials for all but the most cost sensitive applications. Lower cost iron powder cores may be used but the increase in core loss will reduce the efficiency of the power supply. This is especially noticeable at low output power. The winding resistance decreases efficiency at the higher output current levels. The winding resistance must be minimized although this usually comes at the expense of a larger inductor.

The power dissipated in the inductor is equal to the sum of the core and copper losses. At higher output loads, the core losses are usually insignificant and can be ignored. At lower

output currents, the core losses can be a significant contributor. Core loss information is usually available from the magnetics vendor.

Copper loss in the inductor is calculated by the equation below:

$$P_{inductorCu} = I_{inductor(rms)}^2 \times R_{winding}$$

The resistance of the copper wire, $R_{winding}$, increases with temperature. The value of the winding resistance used should be at the operating temperature.

$$R_{winding(hot)} = R_{winding(20^\circ C)} \times (1 + 0.0042 \times (T_{hot} - T_{20^\circ C}))$$

where:

T_{HOT} = temperature of the wire under operating load

$T_{20^\circ C}$ = ambient temperature

$R_{winding(20^\circ C)}$ is room temperature winding resistance (usually specified by the manufacturer)

Current-Sense Resistor Selection

Low inductance power resistors, such as metal film resistors should be used. Most resistor manufacturers make low inductance resistors with low temperature coefficients, designed specifically for current-sense applications. Both resistance and power dissipation must be calculated before the resistor is selected. The value of R_{SENSE} is chosen based on the maximum output current and the maximum threshold level. The power dissipated is based on the maximum peak output current at the minimum overcurrent threshold limit.

$$R_{SENSE} = \frac{75mV}{I_{OUT(max)}}$$

The maximum overcurrent threshold is:

$$I_{overcurrent(max)} = \frac{135mV}{R_{CS}}$$

The maximum power dissipated in the sense resistor is:

$$P_{D(R_{SENSE})} = I_{overcurrent(max)}^2 \times R_{CS}$$

MOSFET Selection

External N-channel logic-level power MOSFETs must be used for the high- and low-side switches. The MOSFET gate-to-source drive voltage of the MIC2182 is regulated by an internal 5V V_{DD} regulator. Logic-level MOSFETs, whose operation is specified at $V_{GS} = 4.5V$ must be used.

It is important to note the on-resistance of a MOSFET increases with increasing temperature. A 75°C rise in junction temperature will increase the channel resistance of the MOSFET by 50% to 75% of the resistance specified at 25°C. This change in resistance must be accounted for when calculating MOSFET power dissipation.

Total gate charge is the charge required to turn the MOSFET on and off under specified operating conditions (V_{DS} and V_{GS}). The gate charge is supplied by the MIC2182 gate drive circuit. At 300kHz switching frequency and above, the gate

charge can be a significant source of power dissipation in the MIC2182. At low output load this power dissipation is noticeable as a reduction in efficiency. The average current required to drive the high-side MOSFET is:

$$I_{G[\text{high-side}](\text{avg})} = Q_G \times f_S$$

where:

$$I_{G[\text{high-side}](\text{avg})} = \text{average high-side MOSFET gate current}$$

Q_G = total gate charge for the high-side MOSFET taken from manufacturer's data sheet with $V_{GS} = 5V$.

The low-side MOSFET is turned on and off at $V_{DS} = 0$ because the freewheeling diode is conducting during this time. The switching losses for the low-side MOSFET is usually negligible. Also, the gate drive current for the low-side MOSFET is more accurately calculated using C_{ISS} at $V_{DS} = 0$ instead of gate charge.

For the low-side MOSFET:

$$I_{G[\text{low-side}](\text{avg})} = C_{ISS} \times V_{GS} \times f_S$$

Since the current from the gate drive comes from the input voltage, the power dissipated in the MIC2182 due to gate drive is:

$$P_{\text{gate drive}} = V_{IN} (I_{G[\text{high-side}](\text{avg})} + I_{G[\text{low-side}](\text{avg})})$$

A convenient figure of merit for switching MOSFETs is the on-resistance times the total gate charge ($R_{DS(\text{on})} \times Q_G$). Lower numbers translate into higher efficiency. Low gate-charge logic-level MOSFETs are a good choice for use with the MIC2182. Power dissipation in the MIC2182 package limits the maximum gate drive current. Refer to Figure 10 for the MIC2182 gate drive limits.

Parameters that are important to MOSFET switch selection are:

- Voltage rating
- On-resistance
- Total gate charge

The voltage rating of the MOSFETs are essentially equal to the input voltage. A safety factor of 20% should be added to the $V_{DS(\text{max})}$ of the MOSFETs to account for voltage spikes due to circuit parasitics.

The power dissipated in the switching transistor is the sum of the conduction losses during the on-time ($P_{\text{conduction}}$) and the switching losses that occur during the period of time when the MOSFETs turn on and off (P_{AC}).

$$P_{SW} = P_{\text{conduction}} + P_{AC}$$

where:

$$P_{\text{conduction}} = I_{SW(\text{rms})}^2 \times R_{SW}$$

$$P_{AC} = P_{AC(\text{off})} + P_{AC(\text{on})}$$

R_{SW} = on-resistance of the MOSFET switch.

Making the assumption the turn-on and turnoff transition times are equal, the transition time can be approximated by:

$$t_T = \frac{C_{ISS} \times V_{GS} + C_{OSS} \times V_{IN}}{I_G}$$

where:

C_{ISS} and C_{OSS} are measured at $V_{DS} = 0$.

I_G = gate drive current (1A for the MIC2182)

The total high-side MOSFET switching loss is:

$$P_{AC} = (V_{IN} + V_D) \times I_{PK} \times t_T \times f_S$$

where:

t_T = switching transition time (typically 20ns to 50ns)

V_D = freewheeling diode drop, typically 0.5V.

f_S is the switching frequency, nominally 300kHz

The low-side MOSFET switching losses are negligible and can be ignored for these calculations.

RMS Current and MOSFET Power Dissipation Calculation

Under normal operation, the high-side MOSFET's RMS current is greatest when V_{IN} is low (maximum duty cycle). The low-side MOSFET's RMS current is greatest when V_{IN} is high (minimum duty cycle). However, the maximum stress the MOSFETs see occurs during short circuit conditions, where the output current is equal to $I_{\text{overcurrent}(\text{max})}$. (See the Sense Resistor section). The calculations below are for normal operation. To calculate the stress under short circuit conditions, substitute $I_{\text{overcurrent}(\text{max})}$ for $I_{\text{OUT}(\text{max})}$. Use the formula below to calculate D under short circuit conditions.

$$D_{\text{short circuit}} = 0.063 - 1.8 \times 10^{-3} \times V_{IN}$$

The RMS value of the high-side switch current is:

$$I_{SW(\text{highside})}(\text{rms}) = \sqrt{D \times \left(I_{\text{OUT}(\text{max})}^2 + \frac{I_{PP}^2}{12} \right)}$$

$$I_{SW(\text{lowside})}(\text{rms}) = \sqrt{(1-D) \times \left(I_{\text{OUT}(\text{max})}^2 + \frac{I_{PP}^2}{12} \right)}$$

where:

D = duty cycle of the converter

$$D = \frac{V_{OUT}}{\eta \times V_{IN}}$$

η = efficiency of the converter.

Converter efficiency depends on component parameters, which have not yet been selected. For design purposes, an efficiency of 90% can be used for V_{IN} less than 10V and 85% can be used for V_{IN} greater than 10V. The efficiency can be more accurately calculated once the design is complete. If the assumed efficiency is grossly inaccurate, a second iteration through the design procedure can be made.

For the high-side switch, the maximum dc power dissipation is:

$$P_{\text{switch1}(\text{dc})} = R_{DS(\text{on})1} \times I_{SW1}(\text{rms})^2$$

For the low-side switch (N-channel MOSFET), the dc power dissipation is:

$$P_{\text{switch2(dc)}} = R_{\text{DS(on)2}} \times I_{\text{SW2(rms)}}^2$$

Since the ac switching losses for the low side MOSFET is near zero, the total power dissipation is:

$$P_{\text{low-side MOSFET(max)}} = P_{\text{switch2(dc)}}$$

The total power dissipation for the high-side MOSFET is:

$$P_{\text{highsideMOSFET(max)}} = P_{\text{SWITCH1(dc)}} + P_{\text{AC}}$$

External Schottky Diode

An external freewheeling diode is used to keep the inductor current flow continuous while both MOSFETs are turned off. This dead time prevents current from flowing unimpeded through both MOSFETs and is typically 80ns. The diode conducts twice during each switching cycle. Although the average current through this diode is small, the diode must be able to handle the peak current.

$$I_{\text{D(avg)}} = I_{\text{OUT}} \times 2 \times 80\text{ns} \times f_{\text{S}}$$

The reverse voltage requirement of the diode is:

$$V_{\text{diode(rrm)}} = V_{\text{IN}}$$

The power dissipated by the Schottky diode is:

$$P_{\text{diode}} = I_{\text{D(avg)}} \times V_{\text{F}}$$

where:

V_{F} = forward voltage at the peak diode current

The external Schottky diode, D2, is not necessary for circuit operation since the low-side MOSFET contains a parasitic body diode. The external diode will improve efficiency and decrease high frequency noise. If the MOSFET body diode is used, it must be rated to handle the peak and average current. The body diode has a relatively slow reverse recovery time and a relatively high forward voltage drop. The power lost in the diode is proportional to the forward voltage drop of the diode. As the high-side MOSFET starts to turn on, the body diode becomes a short circuit for the reverse recovery period, dissipating additional power. The diode recovery and the

circuit inductance will cause ringing during the high-side MOSFET turn-on.

An external Schottky diode conducts at a lower forward voltage preventing the body diode in the MOSFET from turning on. The lower forward voltage drop dissipates less power than the body diode. The lack of a reverse recovery mechanism in a Schottky diode causes less ringing and less power loss. Depending on the circuit components and operating conditions, an external Schottky diode will give a 1/2% to 1% improvement in efficiency. Figure 12 illustrates the difference in noise on the VSW pin with and without a Schottky diode.

Output Capacitor Selection

The output capacitor values are usually determined by the capacitors ESR (equivalent series resistance). Voltage rating and RMS current capability are two other important factors in selecting the output capacitor. Recommended capacitors are tantalum, low-ESR aluminum electrolytics, and OS-CON.

The output capacitor's ESR is usually the main cause of output ripple. The maximum value of ESR is calculated by:

$$R_{\text{ESR}} \leq \frac{\Delta V_{\text{OUT}}}{I_{\text{PP}}}$$

where:

V_{OUT} = peak to peak output voltage ripple

I_{PP} = peak to peak inductor ripple current

The total output ripple is a combination of the ESR and the output capacitance. The total ripple is calculated below:

$$\Delta V_{\text{OUT}} = \sqrt{\left(\frac{I_{\text{PP}} \times (1-D)}{C_{\text{OUT}} \times f_{\text{S}}} \right)^2 + (I_{\text{PP}} \times R_{\text{ESR}})^2}$$

where:

D = duty cycle

C_{OUT} = output capacitance value

f_{S} = switching frequency

The voltage rating of capacitor should be twice the output voltage for a tantalum and 20% greater for an aluminum electrolytic or OS-CON.

The output capacitor RMS current is calculated below:

$$I_{\text{C}_{\text{OUT}}}(\text{rms}) = \frac{I_{\text{PP}}}{\sqrt{12}}$$

The power dissipated in the output capacitor is:

$$P_{\text{DISS}(C_{\text{OUT}})} = I_{\text{C}_{\text{OUT}}}(\text{rms})^2 \times R_{\text{ESR}(C_{\text{OUT}})}$$

Input Capacitor Selection

The input capacitor should be selected for ripple current rating and voltage rating. Tantalum input capacitors may fail when subjected to high inrush currents, caused by turning the input supply on. Tantalum input capacitor voltage rating should be at least 2 times the maximum input voltage to maximize reliability. Aluminum electrolytic, OS-CON, and multilayer polymer film capacitors can handle the higher inrush currents without voltage derating.

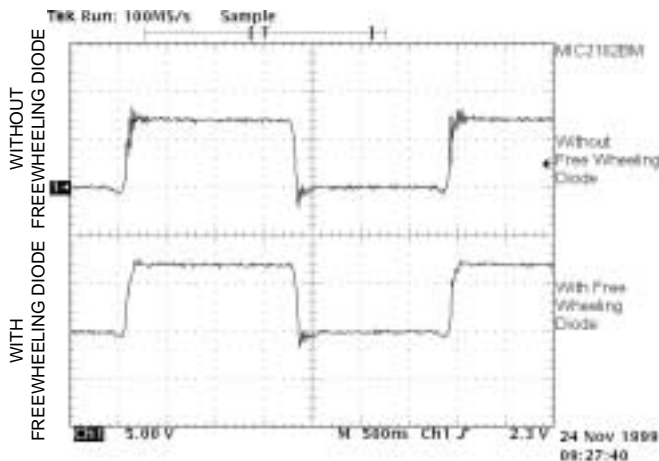

Figure 12. Switch Output Noise With and Without Schottky Diode

The input voltage ripple will primarily depend on the input capacitors ESR. The peak input current is equal to the peak inductor current, so:

$$\Delta V_{IN} = I_{\text{inductor(peak)}} \times R_{\text{ESR}(C_{IN})}$$

The input capacitor must be rated for the input current ripple. The RMS value of input capacitor current is determined at the maximum output current. Assuming the peak to peak inductor ripple current is low:

$$I_{C_{IN}}(\text{rms}) \approx I_{\text{OUT(max)}} \times \sqrt{D \times (1-D)}$$

The power dissipated in the input capacitor is:

$$P_{\text{DISS}(C_{IN})} = I_{C_{IN}}(\text{rms})^2 \times R_{\text{ESR}(C_{IN})}$$

Voltage Setting Components

The MIC2182-3.3 and MIC2182-5.0 ICs contain internal voltage dividers that set the output voltage. The MIC2182 adjustable version requires two resistors to set the output voltage as shown in Figure 13.

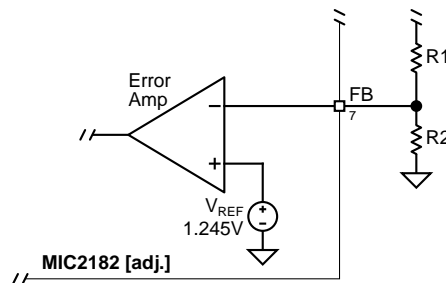

Figure 13. Voltage-Divider Configuration

The output voltage is determined by the equation:

$$V_O = V_{\text{REF}} \times \left(1 + \frac{R1}{R2}\right)$$

Where: V_{REF} for the MIC2182 is typically 1.245V.

A typical value of R1 can be between 3k and 10k. If R1 is too large it may allow noise to be introduced into the voltage feedback loop. If R1 is too small in value it will decrease the efficiency of the power supply, especially at low output loads.

Once R1 is selected, R2 can be calculated using:

$$R2 = \frac{V_{\text{REF}} \times R1}{V_O - V_{\text{REF}}}$$

Voltage Divider Power Dissipation

The reference voltage and R2 set the current through the voltage divider.

$$I_{\text{divider}} = \frac{V_{\text{REF}}}{R2}$$

The power dissipated by the divider resistors is:

$$P_{\text{divider}} = (R1 + R2) \times I_{\text{divider}}^2$$

Efficiency Calculation and Considerations

Efficiency is the ratio of output power to input power. The difference is dissipated as heat in the buck converter. Under light output load, the significant contributors are:

- Supply current to the MIC2182
- MOSFET gate-charge power (included in the IC supply current)
- Core losses in the output inductor

To maximize efficiency at light loads:

- Use a low gate-charge MOSFET or use the smallest MOSFET, which is still adequate for maximum output current.
- Allow the MIC2182 to run in skip mode at lower currents.
- Use a ferrite material for the inductor core, which has less core loss than an MPP or iron power core.

Under heavy output loads the significant contributors to power loss are (in approximate order of magnitude):

- Resistive on-time losses in the MOSFETs
- Switching transition losses in the MOSFETs
- Inductor resistive losses
- Current-sense resistor losses
- Input capacitor resistive losses (due to the capacitors ESR)

To minimize power loss under heavy loads:

- Use logic-level, low on-resistance MOSFETs. Multiplying the gate charge by the on-resistance gives a Figure of merit, providing a good balance between low and high load efficiency.
- Slow transition times and oscillations on the voltage and current waveforms dissipate more power during turn-on and turnoff of the MOSFETs. A clean layout will minimize parasitic inductance and capacitance in the gate drive and high current paths. This will allow the fastest transition times and waveforms without oscillations. Low gate-charge MOSFETs will transition faster than those with higher gate-charge requirements.
- For the same size inductor, a lower value will have fewer turns and therefore, lower winding resistance. However, using too small of a value will require more output capacitors to filter the output ripple, which will force a smaller bandwidth, slower transient response and possible instability under certain conditions.
- Lowering the current-sense resistor value will decrease the power dissipated in the resistor. However, it will also increase the overcurrent limit and will require larger MOSFETs and inductor components.
- Use low-ESR input capacitors to minimize the power dissipated in the capacitors ESR.

Decoupling Capacitor Selection

The 4.7 μ F decoupling capacitor is used to minimize noise on the VDD pin. The placement of this capacitor is critical to the proper operation of the IC. It must be placed right next to the

pins and routed with a wide trace. The capacitor should be a good quality tantalum. An additional $1\mu\text{F}$ ceramic capacitor may be necessary when driving large MOSFETs with high gate capacitance. Incorrect placement of the V_{DD} decoupling capacitor will cause jitter or oscillations in the switching waveform and large variations in the overcurrent limit.

A $0.1\mu\text{F}$ ceramic capacitor is required to decouple the VIN. The capacitor should be placed near the IC and connected directly to between pin 10 (Vcc) and pin 12 (PGND).

PCB Layout and Checklist

PCB layout is critical to achieve reliable, stable and efficient performance. A ground plane is required to control EMI and minimize the inductance in power, signal and return paths.

The following guidelines should be followed to insure proper operation of the circuit.

- Signal and power grounds should be kept separate and connected at only one location. Large currents or high di/dt signals that occur when the MOSFETs turn on and off must be kept away from the small signal connections.
- The connection between the current-sense resistor and the MIC2182 current-sense inputs (pin 8 and 9) should have separate traces, routed from the terminals directly to the IC pins. The traces should be routed as closely as possible to each other and their length should be minimized. Avoid running the traces under the inductor and other switching components. A 1nF to $0.1\mu\text{F}$ capacitor placed between pins 8 and 9 will help attenuate switching noise on the current sense traces. This capacitor should be placed close to pins 8 and 9.
- When the high-side MOSFET is switched on, the critical flow of current is from the input capacitor through the MOSFET, inductor, sense resistor, output capacitor, and back to the input capacitor. These paths must be made with short, wide pieces of trace. It is good practice to locate the ground terminals of the input and output capacitors close to each.
- When the low-side MOSFET is switched on, current flows through the inductor, sense resistor, output capacitor, and MOSFET. The source of the low-side MOSFET should be located close to the output capacitor.
- The freewheeling diode, D1 in Figure 2, conducts current during the dead time, when both MOSFETs are off. The anode of the diode should be located close to the output capacitor ground terminal and the cathode should be located close to the input side of the inductor.
- The $4.7\mu\text{F}$ capacitor, which connects to the VDD terminal (pin 11) must be located right at the IC. The VDD terminal is very noise sensitive and placement of this capacitor is very critical. Connections must be made with wide trace. The capacitor may be located on the bottom layer of the board and connected to the IC with multiple vias.
- The V_{IN} bypass capacitor should be located close to the IC and connected between pins 10 and 12. Connections should be made with a ground and power plane or with short, wide trace.

Predesigned Circuits

A single schematic diagram, shown in Figure 14, can be used to build power supplies ranging from 3A to 10A at the common output voltages of 1.8V, 2.5V, 3.3V, and 5V. Components that vary, depending upon output current and voltage, are listed in the accompanying Tables 3 through 6.

Power supplies larger than 10A can also be constructed using the MIC2182 using larger power-handling components.

The “Power Supply Operating Characteristics” graphs following the component and vendor tables provide useful information about the actual performance of some of these circuits.

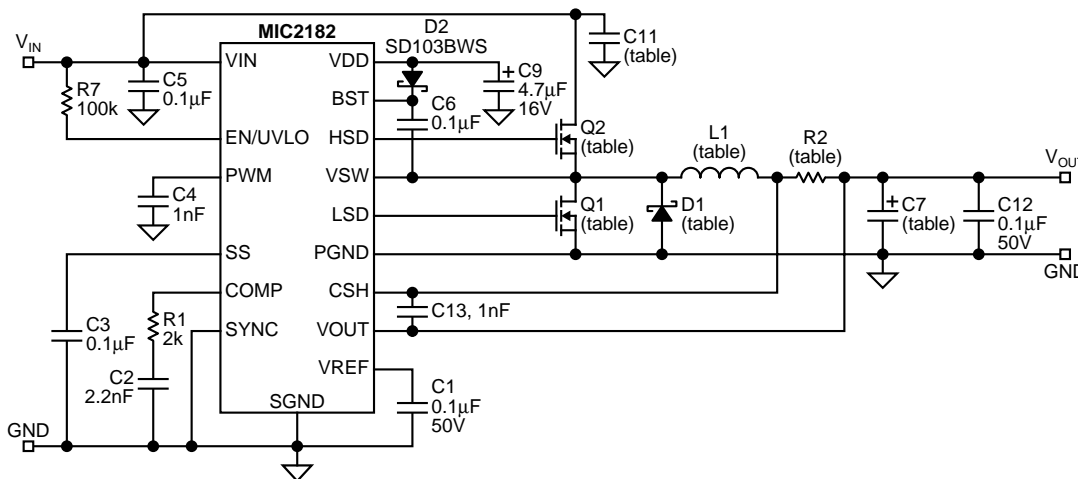

Figure 14. Basic Circuit Diagram for Use with Tables 3 through 6

Specification	Limit
Switching frequency ripple	1% of output voltage
Maximum ambient temperature	85° C
Short-circuit capability	Continuous
Switching frequency	300kHz

Table 1. Specifications for Figure 14 and Tables 3 through 6

Manufacturer	Telephone Number (USA)	Web Address
AVX	(803) 946-0690	www.avxcorp.com
Central Semiconductor	(516) 435-1110	www.centalsemi.com
Coiltronics	(561) 241-7876	www.coiltronics.com
IRC	(704) 264-8861	
IR	(310) 322-3331	www.irf.com
Micrel	(408) 944-0800	www.micrel.com
Vishay/Lite On (diodes)	(805) 446-4800	www.vishay-liteon.com
Vishay/Siliconix (MOSFETs)	(800) 554-5665	www.siliconix.com
Vishay/Dale (inductors and resistors)	(800) 487-9437	www.vishaytechno.com
Sumida	(847) 956-0666	www.japanlink.com/sumida

Table 2. Component Suppliers

Reference	3A (6.5V–30V) Part No. / Description	4A (6.5V–30V) Part No. / Description	5A (6.5V–30V) Part No. / Description	10A (6.5V–10V) Part No. / Description
C7	qty: 2 TPSE227M010R0100 AVX, 220 μ F 10V, 0.1 Ω ESR, output filter capacitor	qty: 2 TPSE227M010R0100 AVX, 220 μ F 10V, 0.1 Ω ESR, output filter capacitor	qty: 2 TPSV227M010R0060 AVX, 220 μ F 10V, 0.06 Ω ESR, output filter capacitor	qty: 2 TPSV337M010R0060 AVX, 330 μ F 10V, 0.06 Ω ESR, output filter capacitor
C11	qty: 2 TPSE226M035R0300 AVX, 22 μ F 35V, 0.3 Ω ESR, input filter capacitor	qty: 3 TPSE226M035R0300 AVX, 22 μ F 35V, 0.3 Ω ESR, input filter capacitor	qty: 4 TPSE226M035R0300 AVX, 22 μ F 35V, 0.3 Ω ESR, input filter capacitor	qty: 4 TPSV107M020R0085 AVX, 100 μ F 20V, 0.06 Ω ESR, input filter capacitor
D1	qty: 1 B140, Vishay, freewheeling diode	qty: 1 B140, Vishay, freewheeling diode	qty: 1 B140, Vishay, freewheeling diode	qty: 1 B330, Vishay, freewheeling diode
L1	qty: 1 CDRH125-100, Sumida Inductor, 10 μ H 4A, output inductor	qty: 1 CDRH127-100, Sumida Inductor, 10 μ H 5A, output inductor	qty: 1 CDRH127-100 Sumida, 10 μ H 5A, output inductor	qty: 1 UP4B-3R3, Coiltronics, 3.3 μ H 11A, output inductor
Q1	qty: 1 Si4800, Siliconix, low-side MOSFET	qty: 1 Si4800, Siliconix, low-side MOSFET	qty: 1 Si4884, Siliconix, low-side MOSFET	qty: 2 Si4884, Siliconix low-side MOSFET
Q2	qty: 1 Si4800, Siliconix, high-side MOSFET	qty: 1 Si4800, Siliconix, high-side MOSFET	qty: 1 Si4884, Siliconix, high-side MOSFET	qty: 2 Si4884, Siliconix, high-side MOSFET
R2	qty: 1 WSL-2010 .025 1%, Vishay, 0.025, 1%, 0.5W, current sense resistor	qty: 1 WSL-2010 .020 1%, Vishay, 0.02, 1%, 0.5W, current sense resistor	qty: 1 WSL-2512 .015 1%, Vishay, 0.015, 1%, 1W, current sense resistor	qty: 2 WSL-2512 .015 1% , Vishay, 0.015, 1%, 1W, current sense resistor
U1	MIC2182-5.0BSM or MIC2182-5.0BM	MIC2182-5.0BSM or MIC2182-5.0BM	MIC2182-5.0BSM or MIC2182-5.0BM	MIC2182-5.0BM

Table 3. Components for 5V Output

Reference	3A (4.5V–30V) Part No. / Description	4A (4.5V–30V) Part No. / Description	5A (4.5V–30V) Part No. / Description	10A (4.5V–5.5V) Part No. / Description
C7	qty: 2 TPSE227M010R0100 AVX, 220 μ F 10V, 0.1 Ω ESR, output filter capacitor	qty: 2 TPSE227M010R0100 AVX, 220 μ F 10V, 0.1 Ω ESR, output filter capacitor	qty: 2 TPSV227M010R0060 AVX, 220 μ F 10V, 0.06 Ω ESR, output filter capacitor	qty: 2 TPSV477M006R0055 AVX, 470 μ F 6.3V, 0.055 Ω ESR, output filter capacitor
C11	qty: 2 TPSE226M035R0300 AVX, 22 μ F 35V, 0.3 Ω ESR, input filter capacitor	qty: 2 TPSE226M035R0300 AVX, 22 μ F 35V, 0.3 Ω ESR, input filter capacitor	qty: 3 TPSE226M035R0300 AVX, 22 μ F 35V, 0.3 Ω ESR, input filter capacitor	qty: 3 TPSV227M016R0075 AVX, 220 μ F 16V, 0.075 Ω ESR, filter capacitor
D1	qty: 1 B140, Vishay, freewheeling diode	qty: 1 B140, Vishay, freewheeling diode	qty: 1 B140, Vishay, freewheeling diode	qty: 1 B330, Vishay, freewheeling diode
L1	qty: 1 CDRH125-100, Sumida Inductor, 10 μ H 4A, output inductor	qty: 1 CDRH127-100, Sumida Inductor, 10 μ H 5A, output inductor	qty: 1 CDRH127-100 Sumida, 10 μ H 5A, output inductor	qty: 1 UP4B-3R3, Coiltronics, 3.3 μ H 11A, output inductor
Q1	qty: 1 Si4800, Siliconix, low-side MOSFET	qty: 1 Si4800, Siliconix, low-side MOSFET	qty: 1 Si4800, Siliconix, low-side MOSFET	qty: 2 Si4884, Siliconix, low-side MOSFET
Q2	qty: 1 Si4800, Siliconix, high-side MOSFET	qty: 1 Si4800, Siliconix, high-side MOSFET	qty: 1 Si4884, Siliconix, high-side MOSFET	qty: 2 Si4884, Siliconix, high-side MOSFET
R2	qty: 1 WSL-2010 .025 1%, Vishay, 0.025, 1%, 0.5W, current sense resistor	qty: 1 WSL-2010 .020 1%, Vishay, 0.02, 1%, 0.5W, current sense resistor	qty: 1 WSL-2512 .015 1%, Vishay, 0.015, 1%, 1W, current sense resistor	qty: 2 WSL-2512 .015 1% , Vishay, 0.015, 1%, 1W, current sense resistor
U1	MIC2182-3.3BSM or MIC2182-3.3BM	MIC2182-3.3BM or MIC2182-3.3BSM	MIC2182-3.3BM or MIC2182-3.3BSM	MIC2182-3.3BM

Table 4. Components for 3.3V Output

Reference	3A (4.5V–30V) Part No. / Description	4A (4.5V–30V) Part No. / Description	5A (4.5V–30V) Part No. / Description	10A (4.5V–5.5V) Part No. / Description
C7	qty: 2 TPSE227M010R0100 AVX, 220 μ F 10V, 0.1 Ω ESR, output filter capacitor	qty: 2 TPSE227M010R0100 AVX, 220 μ F 10V, 0.1 Ω ESR, output filter capacitor	qty: 2 TPSV227M010R0060 AVX, 220 μ F 10V, 0.06 Ω ESR, output filter capacitor	qty: 2 TPSV447M006R0055 AVX, 470 μ F 6.3V, 0.06 Ω ESR, output filter capacitor
C11	qty: 2 TPSE226M035R0300 AVX, 22 μ F 35V, 0.3 Ω ESR, input filter capacitor	qty: 2 TPSE226M035R0300 AVX, 22 μ F 35V, 0.3 Ω ESR, input filter capacitor	qty: 2 TPSE226M035R0300 AVX, 22 μ F 35V, 0.3 Ω ESR, input filter capacitor	qty: 3 TPSV227M016R0075 AVX, 220 μ F 16V, 0.06 Ω ESR, input filter capacitor
D1	qty: 1 B140, Vishay, freewheeling diode	qty: 1 B140, Vishay, freewheeling diode	qty: 1 B140, Vishay, freewheeling diode	qty: 1 B330, Vishay, freewheeling diode
L1	qty: 1 CDRH125-100, Sumida Inductor, 10 μ H 4A, output inductor	qty: 1 CDRH127-100, Sumida Inductor, 10 μ H 5A, output inductor	qty: 1 CDRH127-100 Sumida, 10 μ H 5A, output inductor	qty: 1 UP4B-3R3, Coiltronics, 3.3 μ H 11A, output inductor
Q1	qty: 1 Si4800, Siliconix, low-side MOSFET	qty: 1 Si4884, Siliconix, low-side MOSFET	qty: 1 Si4884, Siliconix, low-side MOSFET	qty: 2 Si4884, Siliconix low-side MOSFET
Q2	qty: 1 Si4800, Siliconix, high-side MOSFET	qty: 1 Si4800, Siliconix, high-side MOSFET	qty: 1 Si4800, Siliconix, high-side MOSFET	qty: 2 Si4884, Siliconix, high-side MOSFET
R2	qty: 1 WSL-2010 .025 1%, Vishay, 0.025, 1%, 0.5W, current sense resistor	qty: 1 WSL-2010 .020 1%, Vishay, 0.02, 1%, 0.5W, current sense resistor	qty: 1 WSL-2512 .015 1%, Vishay, 0.015, 1%, 1W, current sense resistor	qty: 1 WSL-2512 .015 1% , Vishay, 0.015, 1%, 1W, current sense resistor
U1	MIC2182BSM or MIC2182BM	MIC2182BSM or MIC2182BM	MIC2182BSM or MIC2182BM	MIC2182BM

Table 5. Components for 2.5V Output

Reference	3A (4.5V–30V) Part No. / Description	4A (4.5V–30V) Part No. / Description	5A (4.5V–8V) Part No. / Description	10A (4.5V–5.5V) Part No. / Description
C7	qty: 2 TPSE227M010R0100 AVX, 220 μ F 10V, 0.1 Ω ESR, output filter capacitor	qty: 2 TPSE227M010R0100 AVX, 220 μ F 10V, 0.1 Ω ESR, output filter capacitor	qty: 2 TPSV227M010R0060 AVX, 220 μ F 10V, 0.06 Ω ESR, output filter capacitor	qty: 2 TPSV447M006R0055 AVX, 470 μ F 6.3V, 0.06 Ω ESR, output filter capacitor
C11	qty: 2 TPSE226M035R0300 AVX, 22 μ F 35V, 0.3 Ω ESR, input filter capacitor	qty: 2 TPSE226M035R0300 AVX, 22 μ F 35V, 0.3 Ω ESR, input filter capacitor	qty: 2 TPSE226M035R0300 AVX, 22 μ F 35V, 0.3 Ω ESR, input filter capacitor	qty: 2 TPSV227M016R0075 AVX, 220 μ F 16V, 0.06 Ω ESR, input filter capacitor
D1	qty: 1 B140, Vishay, freewheeling diode	qty: 1 B140, Vishay, freewheeling diode	qty: 1 B140, Vishay, freewheeling diode	qty: 1 B330, Vishay, freewheeling diode
L1	qty: 1 CDRH125-100, Sumida Inductor, 10 μ H 4A, output inductor	qty: 1 CDRH127-100, Sumida Inductor, 10 μ H 5A, output inductor	qty: 1 CDRH127-100 Sumida, 10 μ H 5A, output inductor	qty: 1 UP4B-3R3, Coiltronics, 3.3 μ H 11A, output inductor
Q1	qty: 1 Si4800, Siliconix, low-side MOSFET	qty: 1 Si4884, Siliconix, low-side MOSFET	qty: 1 Si4884, Siliconix, low-side MOSFET	qty: 2 Si4884, Siliconix low-side MOSFET
Q2	qty: 1 Si4800, Siliconix, high-side MOSFET	qty: 1 Si4800, Siliconix, high-side MOSFET	qty: 1 Si4800, Siliconix, high-side MOSFET	qty: 2 Si4884, Siliconix, high-side MOSFET
R2	qty: 1 WSL-2010 .025 1%, Vishay, 0.025, 1%, 0.5W, current sense resistor	qty: 1 WSL-2010 .020 1%, Vishay, 0.02, 1%, 0.5W, current sense resistor	qty: 1 WSL-2512 .015 1%, Vishay, 0.015, 1%, 1W, current sense resistor	qty: 2 WSL-2512 .015 1% , Vishay, 0.015, 1%, 1W, current sense resistor
U1	MIC2182BSM or MIC2182BM	MIC2182BSM or MIC2182BM	MIC2182BSM or MIC2182BM	MIC2182BM

Table 6. Components for 1.8V Output

Power Supply Operating Characteristics

Effect of Soft-Start Capacitor (C_{SS}) Value On Output Voltage Waveforms During Turn-On
(10A Power Supply Configuration)

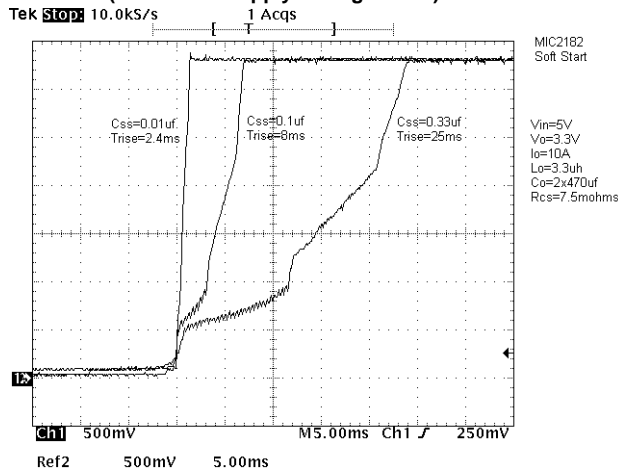

Effect of Soft-Start Capacitor (C_{SS}) Value On Output Voltage Waveforms During Turn-On
(4A Power Supply Configuration)

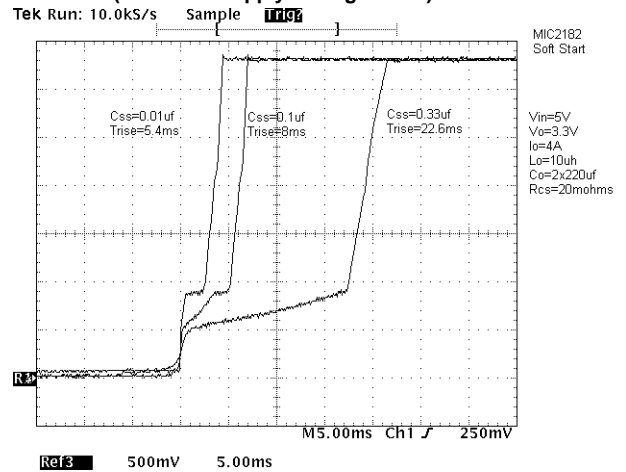

Normal (300kHz Switching Frequency) and Output Short-Circuit (60kHz) Conditions Switch Node (Pin 15) Waveforms

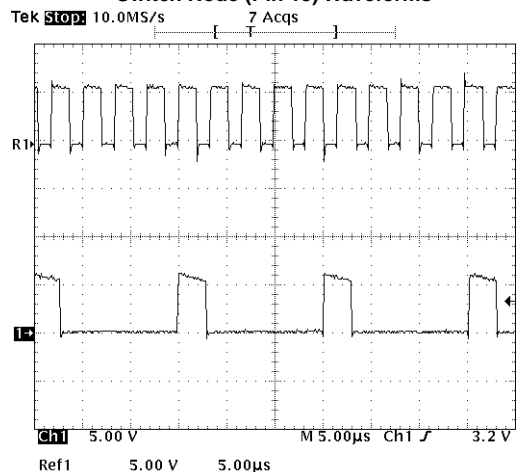

Converter Waveforms

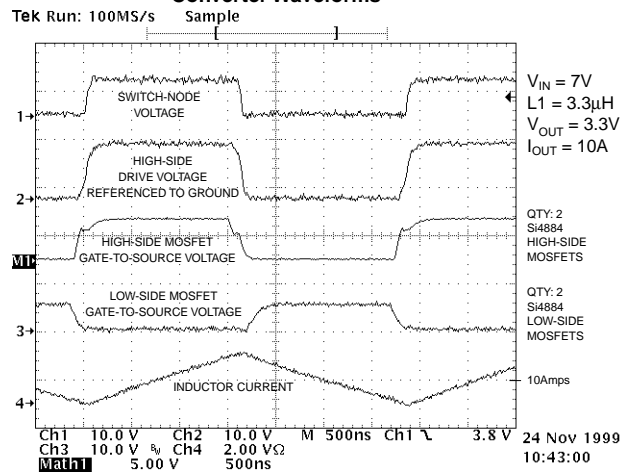

Typical Skip-Mode Waveforms

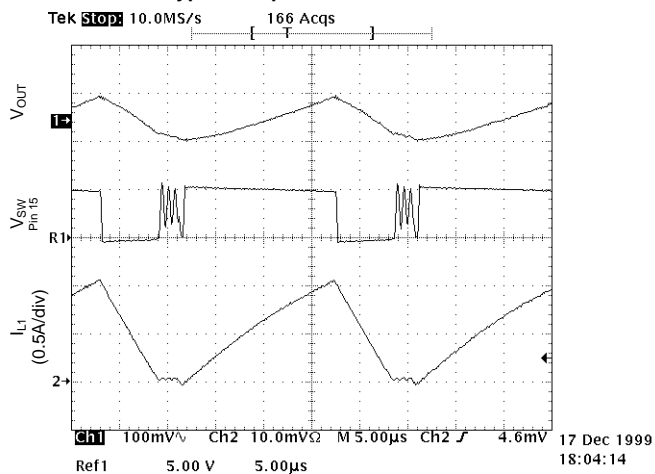

Typical PWM-Mode Waveforms

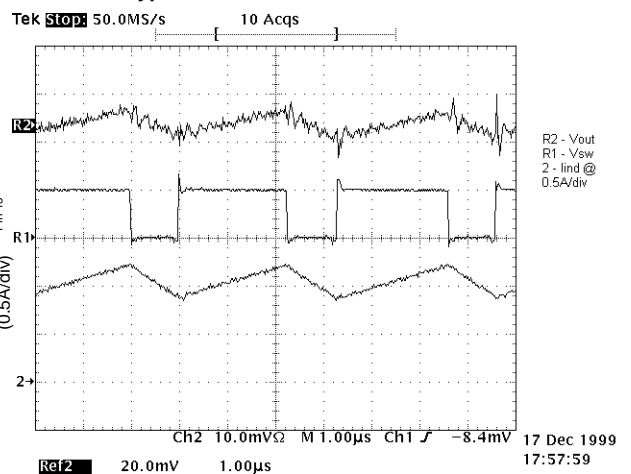

**Load Transient Response and Bode Plot
(4A Power Supply Configuration)**

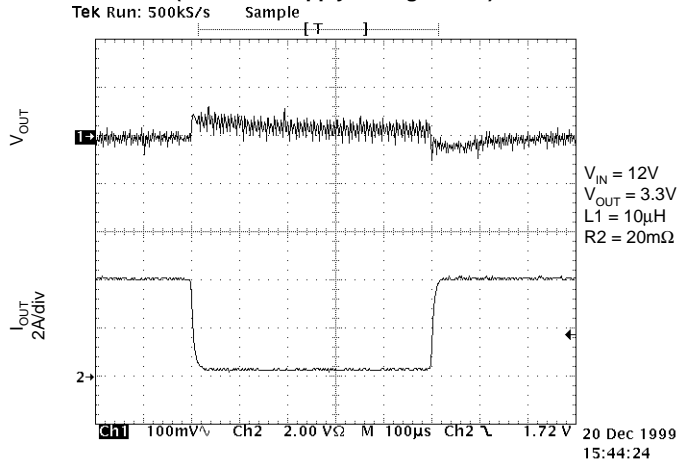

**Load Transient Response and Bode Plot
(10A Power Supply Configuration)**

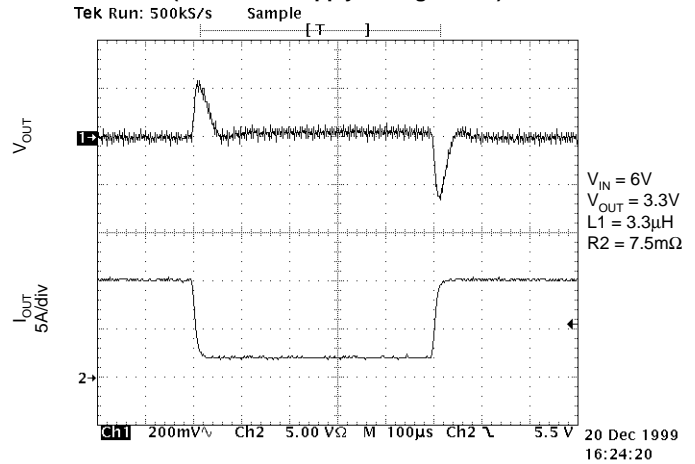

**Bode Plot
(4A Power Supply Configuration)**

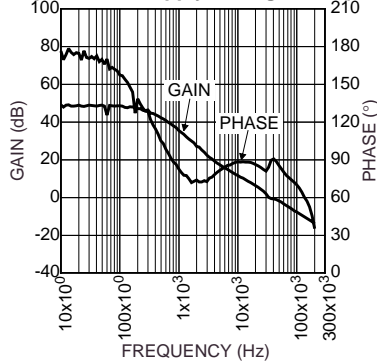

**5V Efficiency
(4A Power Supply Configuration)**

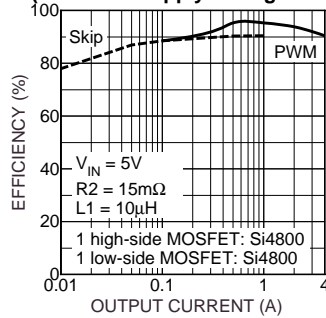

**Bode Plot
(10A Power Supply Configuration)**

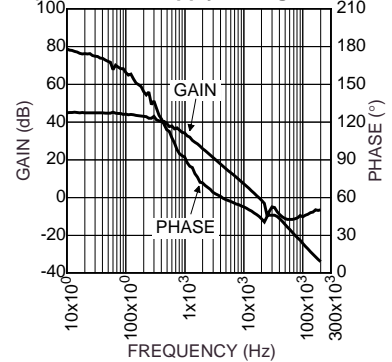

**12V Efficiency
(4A Power Supply Configuration)**

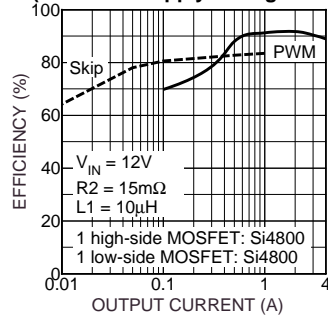

**24V Efficiency
(4A Power Supply Configuration)**

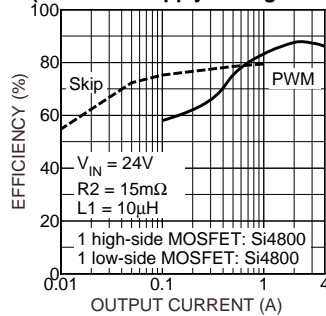

**Efficiency
(10A Power Supply Configuration)**

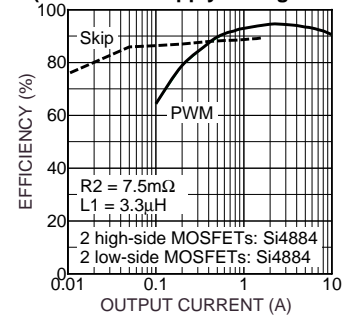

Package Information

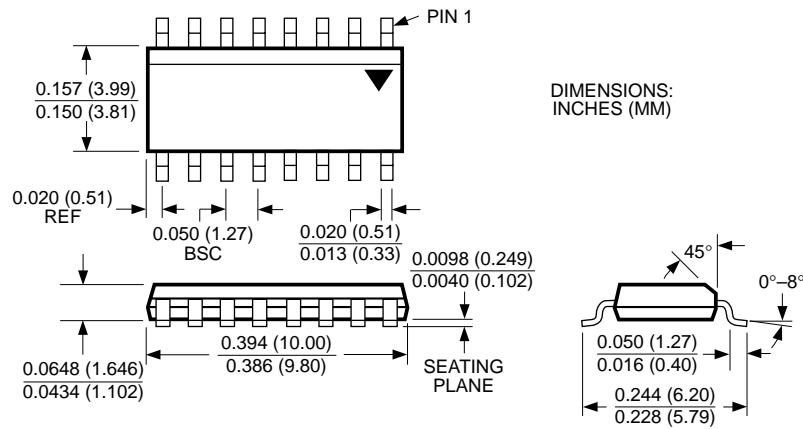

16-pin SOP (M)

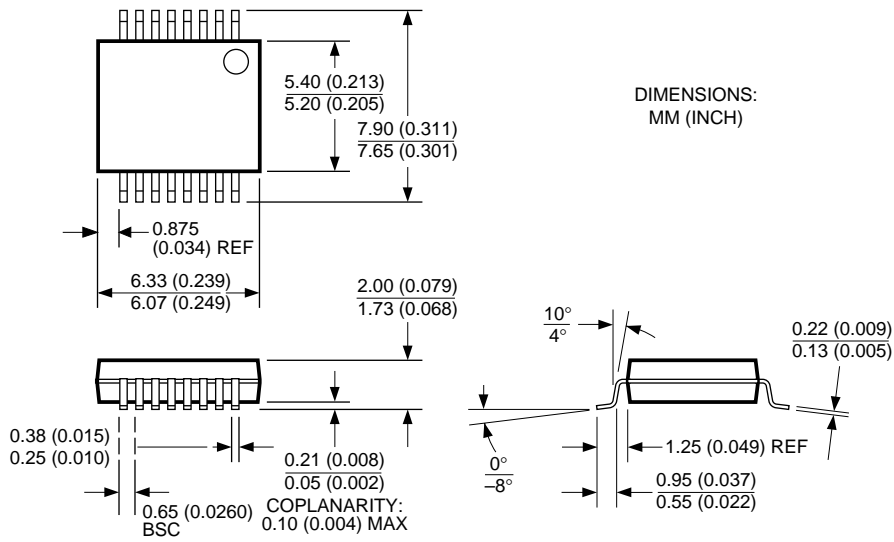

16-Pin SSOP (SM)

MICREL, INC. 1849 FORTUNE DRIVE SAN JOSE, CA 95131 USATEL + 1 (408) 944-0800 FAX + 1 (408) 474-1000 WEB <http://www.micrel.com>

The information furnished by Micrel in this data sheet is believed to be accurate and reliable. However, no responsibility is assumed by Micrel for its use. Micrel reserves the right to change circuitry and specifications at any time without notification to the customer.

Micrel Products are not designed or authorized for use as components in life support appliances, devices or systems where malfunction of a product can reasonably be expected to result in personal injury. Life support devices or systems are devices or systems that (a) are intended for surgical implant into the body or (b) support or sustain life, and whose failure to perform can be reasonably expected to result in a significant injury to the user. A Purchaser's use or sale of Micrel Products for use in life support appliances, devices or systems is at Purchaser's own risk and Purchaser agrees to fully indemnify

Micrel for any damages resulting from such use or sale.

© 2004 Micrel, Incorporated.