

## Absolute Maximum Ratings

Absolute maximum ratings indicate sustained limits beyond which damage to the module may occur. These are not tested at manufacturing. All voltage parameters are absolute voltages referenced to  $V_{SS}$  unless otherwise stated in the table. The thermal resistance rating is measured under board mounted and still air conditions.

Symbol	Description	Min	Max	Unit
$BV_{DSS}$	MOSFET Blocking Voltage	---	500	V
$I_o$	DC output current per MOSFET @ $T_C=25^\circ\text{C}$ (Note1)	---	10	A
$P_d$	Power dissipation per MOSFET @ $T_C = 100^\circ\text{C}$	---	-	W
$T_J$ (MOSFET & IC)	Maximum Operating Junction Temperature	---	150	$^\circ\text{C}$
$T_L$	Lead temperature (soldering 30 seconds)	---	260	$^\circ\text{C}$
$T_S$	Storage Temperature Range	-40	150	$^\circ\text{C}$
$V_B$	High side floating supply voltage	-0.3	$V_S + 20$	V
$V_S$	High side floating supply offset voltage	$V_B - 20$	$V_B + 0.3$	V
$V_{CC}$	Low Side fixed supply voltage	-0.3	20	V
$V_{IN}$	Logic input voltage LIN, HIN	-0.3	$V_{CC} + 0.3$	V
$V_{ISO}$	Isolation voltage (1min) (Note2)	---	1500	$V_{RMS}$

Note1: Calculated based on maximum junction temperature. Bond wires current limit is 3.5A. Note2: Characterized, not tested at manufacturing

## Reccomended Operating Conditions

Symbol	Description	Min	Typ	Max	Units	Conditions
$V^+$	Positive DC Bus Input Voltage	---	---	400	V	
$V_{S1,2,3}$	High Side Floating Supply Offset Voltage	(Note 3)	---	400	V	
$V_{B1,2,3}$	High Side Floating Supply Voltage	$V_S + 12$	---	$V_S + 20$	V	
$V_{CC}$	Low Side and Logic Supply Voltage	13.5	---	16.5	V	
$V_{IN}$	Logic Input Voltage	COM	---	$V_{CC}$	V	
$F_p$	PWM Carrier Frequency	---	---	20	kHz	

For proper operation the module should be used within the recommended conditions. All voltages are absolute referenced to COM. The  $V_S$  offset is tested with all supplies biased at 15V differential.

Note 3: Logic operational for  $V_S$  from COM-8V to COM+500V. Logic state held for  $V_S$  from COM-8V to COM- $V_{BS}$ .

### Static Electrical Characteristics

$V_{BIAS}$  ( $V_{CC}$ ,  $V_{BS}$ )=15V,  $T_J=25^\circ\text{C}$ , unless otherwise specified. The  $V_{IN}$ , and  $I_{IN}$  parameters are referenced to COM

Symbol	Description	Min	Typ	Max	Units	Conditions
$BV_{DSS}$	Drain-to-Source Breakdown Voltage	500	---	---	V	$T_J=25^\circ\text{C}$ , $I_{LK}=3\text{mA}$
$I_{LKH}$	Leakage Current of High Side FET's in Parallel	---	15	---	$\mu\text{A}$	$T_J=25^\circ\text{C}$ , $V_{DS}=500\text{V}$
$I_{LKL}$	Leakage Current of Low Side FET's in Parallel Plus Gate Drive IC	---	20	---	$\mu\text{A}$	$T_J=25^\circ\text{C}$ , $V_{DS}=500\text{V}$
$R_{DS(ON)}$	Drain to Source ON Resistance	---	0.58	0.8	$\Omega$	$T_J=25^\circ\text{C}$ , $V_{CC}=10\text{V}$ , $I_d = 6\text{A}$
		---	1.60	---		$T_J=150^\circ\text{C}$ , $V_{CC}=10\text{V}$ , $I_d = 6\text{A}$ (Note 4)
$V_{SD}$	Diode Forward Voltage	---	0.85	---	V	$T_J=25^\circ\text{C}$ , $V_{CC}=10\text{V}$ , $I_d = 6\text{A}$
$V_{HIN/LIN}$	Logic "1" input voltage for HIN & "0" for LIN	2.2	---	---	V	
$V_{HIN/LIN}$	Logic "0" input voltage for HIN & "1" for LIN	---	---	0.8	V	
$V_{CCUV+}$ , $V_{BSUV+}$	$V_{CC}$ and $V_{BS}$ Supply Under-Voltage, Positive Going Threshold	8	8.9	9.8	V	
$V_{CCUV-}$ , $V_{BSUV-}$	$V_{CC}$ and $V_{BS}$ supply Under-Voltage, Negative Going Threshold	7.4	8.2	9.0	V	
$V_{CCUVH}$ , $V_{BSUVH}$	$V_{CC}$ and $V_{BS}$ Supply Under-Voltage Lock-Out Hysteresis	---	0.7	---	V	
$I_{QBS}$	Quiescent $V_{BS}$ Supply Current $V_{IN}=0\text{V}$	---	45	70	$\mu\text{A}$	
$I_{QCC}$	Quiescent $V_{CC}$ Supply Current $V_{IN}=0\text{V}$	---	1100	3000	$\mu\text{A}$	
$I_{HIN+}$	Input Bias Current $V_{IN}=4\text{V}$	---	5	20	$\mu\text{A}$	
$I_{LIN-}$	Input Bias Current $V_{IN}=0\text{V}$	---	1	2	$\mu\text{A}$	
$R_{BR}$	Internal Bootstrap Equivalent Resistor Value	---	200	---	$\Omega$	$T_J=25^\circ\text{C}$

Note 4: Characterized, not tested at manufacturing

### MOSFET Avalanche Characteristics

Symbol	Description	Min	Typ	Max	Units	Conditions
EAS	Single Pulse Avalanche Energy	---	216	---	mJ	$T_J=25^\circ\text{C}$ , $L=3\text{mH}$ , $V_{DD}=100\text{V}$ , $I_{AS}=12\text{A}$ , TO-220 package.

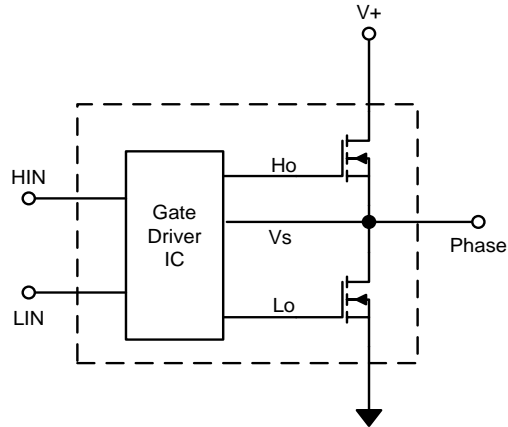
### Dynamic Electrical Characteristics

$V_{BIAS}$  ( $V_{CC}$ ,  $V_{BS}$ )=15V,  $T_J=25^\circ\text{C}$ , unless otherwise specified. Driver only timing unless otherwise specified.

Symbol	Description	Min	Typ	Max	Units	Conditions
$T_{ON}$	Input to Output Propagation Turn-On Delay Time	---	0.8	1.3	$\mu\text{s}$	$I_D=1\text{mA}$ , $V^+=50\text{V}$
$T_{OFF}$	Input to Output Propagation Turn-Off Delay Time	---	0.8	1.3	$\mu\text{s}$	Gate Driver; $V_{LIN}=0$ & $V_{HIN}=5\text{V}$ with no external deadtime
$T_{FIL,IN}$	Input Filter Time (HIN, LIN)	---	300	---	ns	

**Thermal and Mechanical Characteristics**

Symbol	Description	Min	Typ	Max	Units	Conditions
$R_{th(J-B)}$	Thermal resistance, junction to mounting pad, each MOSFET	---	0.9	---	$^{\circ}C/W$	Standard reflow-solder process
$R_{th(J-A)}$	Thermal resistance, junction to ambient, each MOSFET	---	40	---	$^{\circ}C/W$	Mounted on 13.2cm <sup>2</sup> of two-layer FR4 with 36 vias

**Input-Output Logic Level Table**


HIN	LIN	Phase
HI	LO	V+
LO	HI	0
LO	LO	*
HI	HI	**

\* V+ if motor current is flowing into Vs, 0 if current is flowing out of Vs into the motor winding

\*\* Shoot-through condition

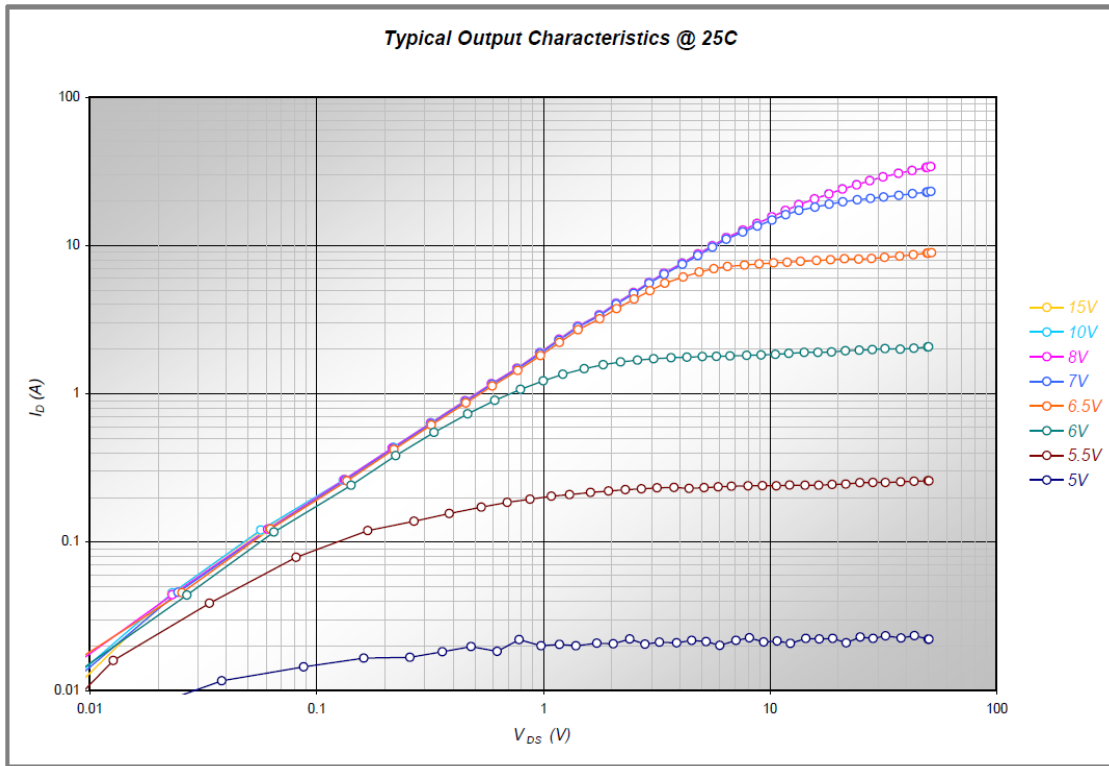


Figure 1 – MOS typical output characteristics at 25°C

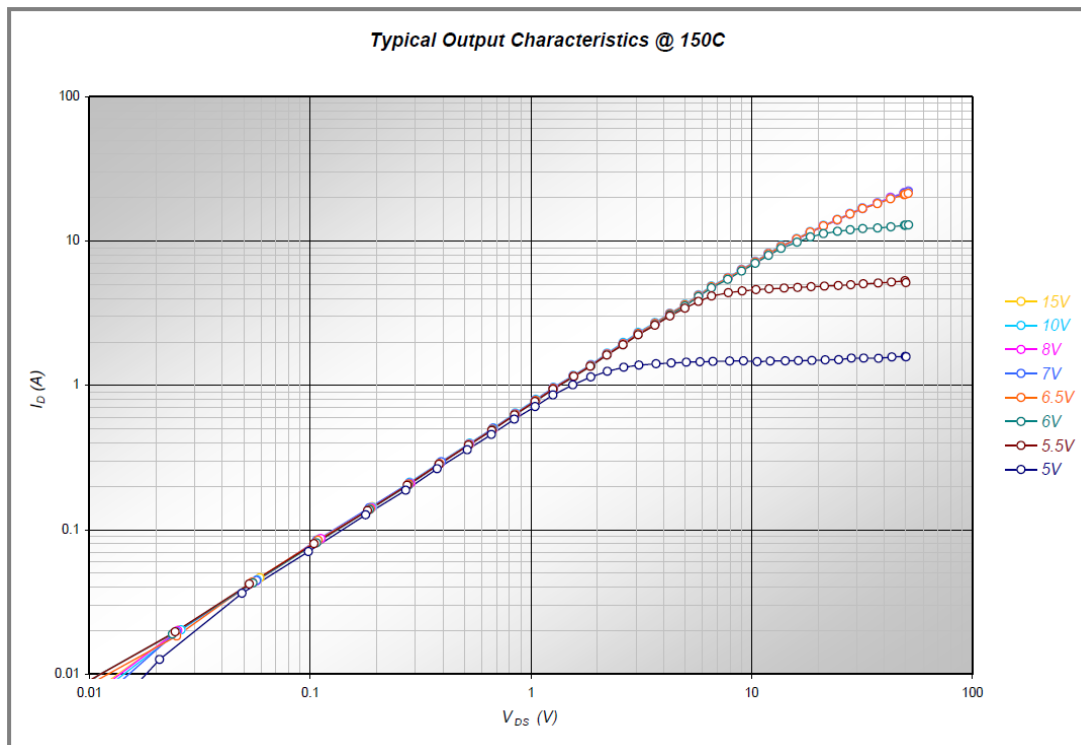


Figure 2 – MOS typical output characteristics at 150°C

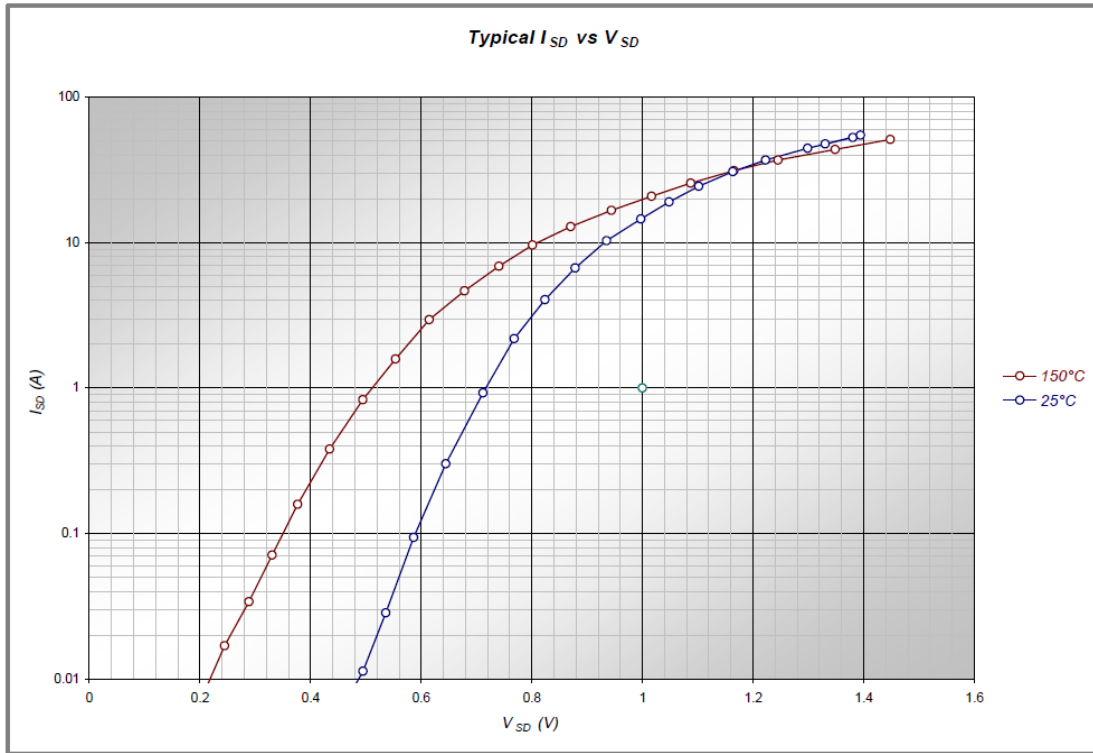


Figure 3 – MOS body diode typical characteristics at 25°C and 150°C

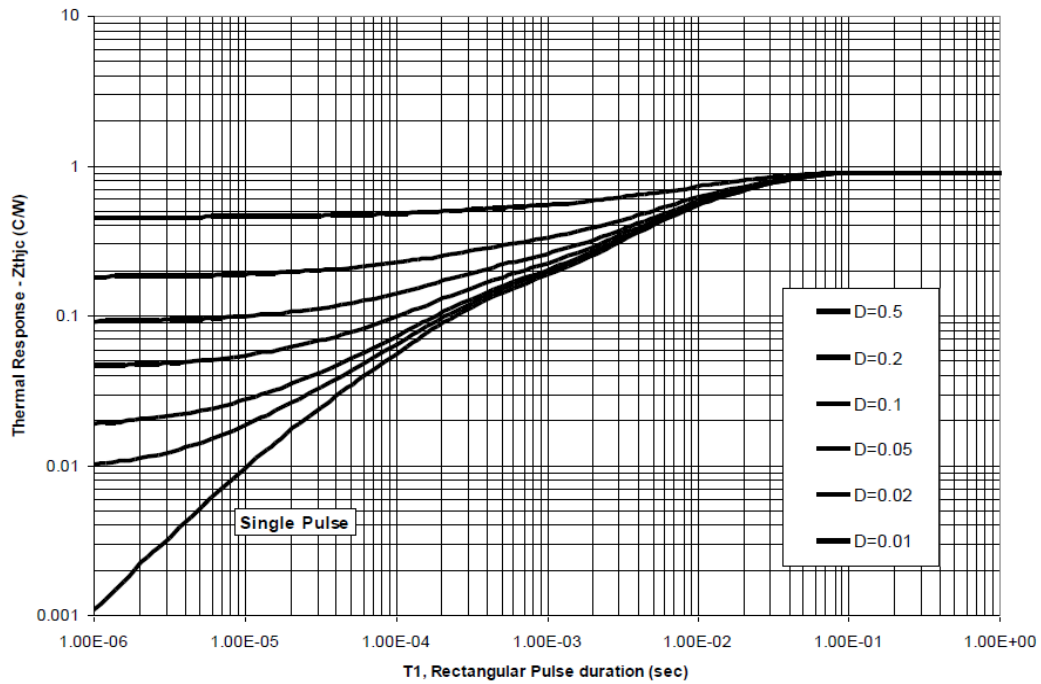


Figure 4 – module top surface typical thermal impedance

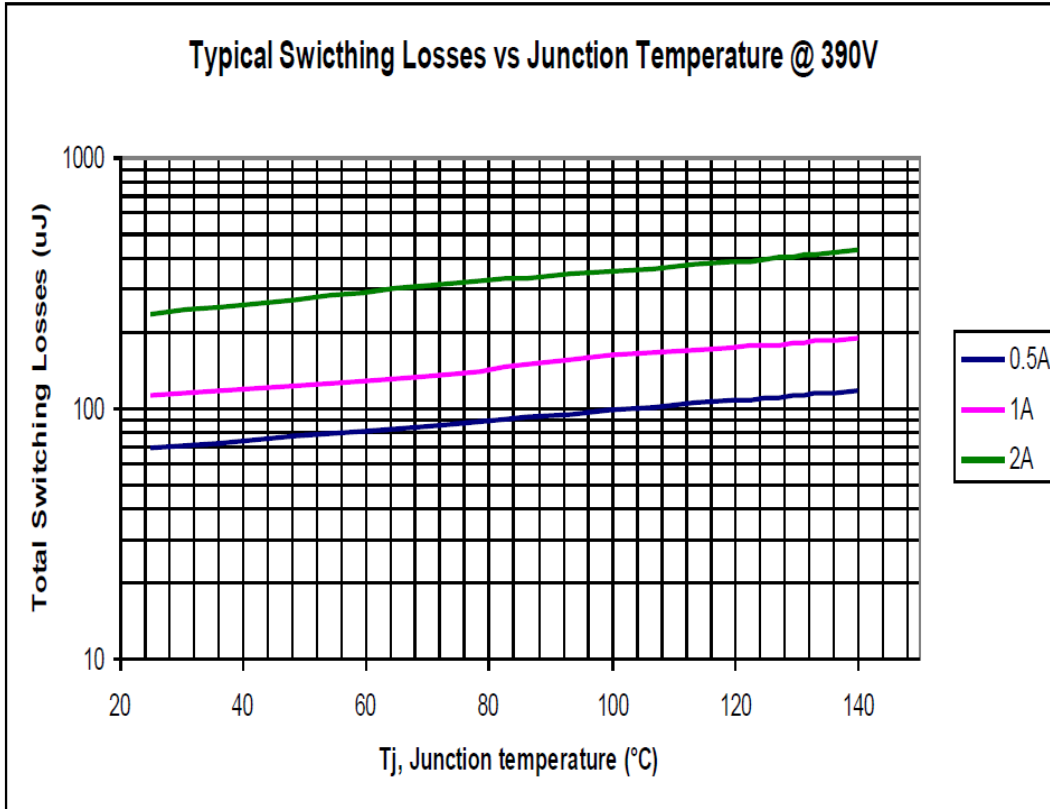


Figure 5 – Typical switching losses at 390V

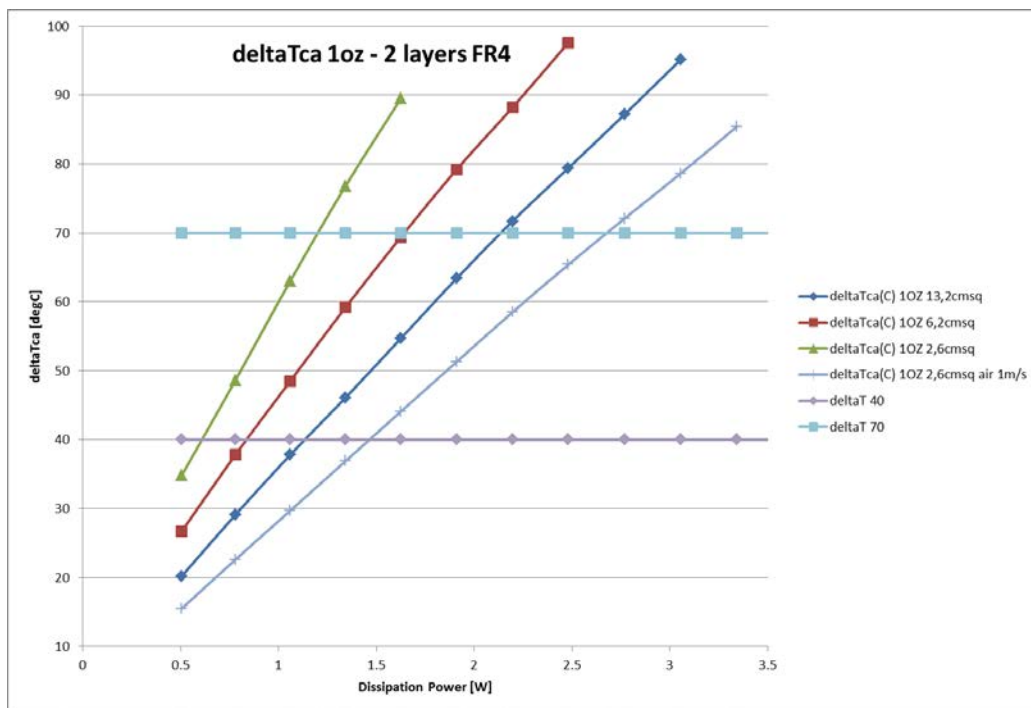


Figure 6 – typical delta temperature between case (no heat-sink) and ambient with 1oz FR4 vs. power dissipation in the module

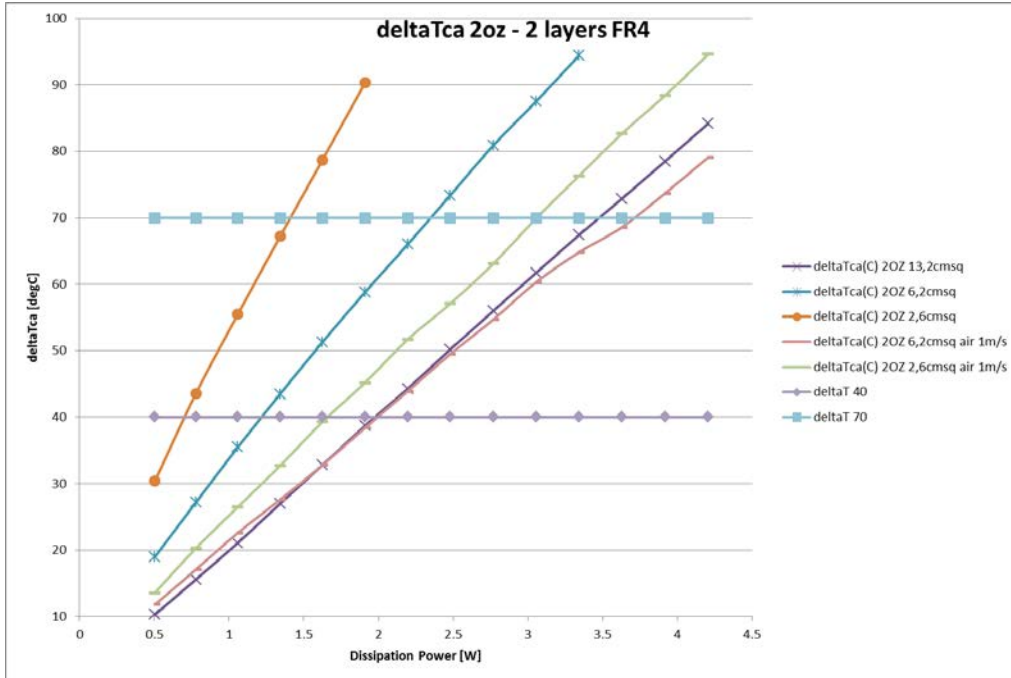


Figure 7 – typical delta temperature between case (no heat-sink) and ambient with 2oz FR4 vs. power dissipation in the module

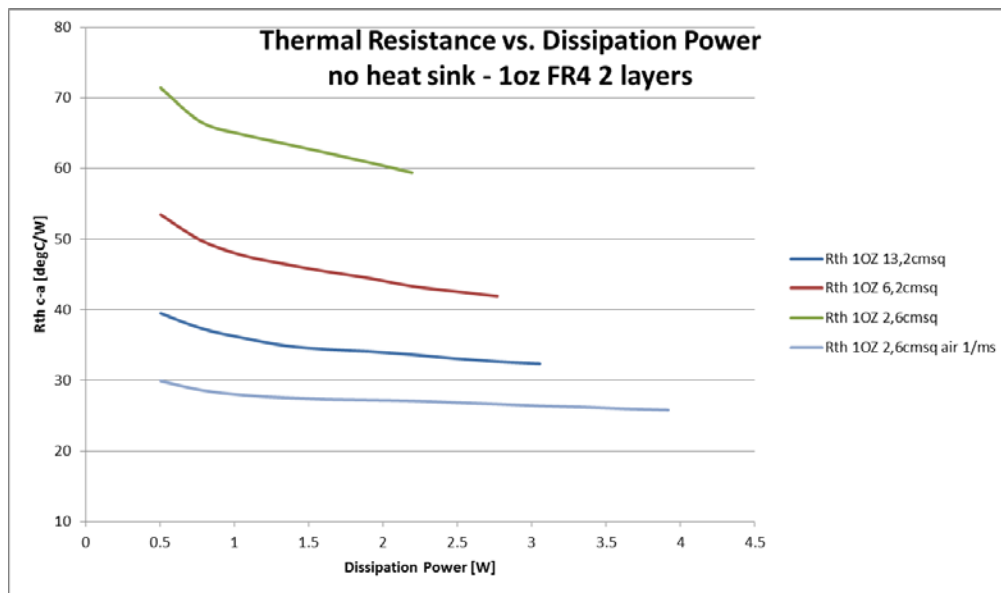


Figure 8 – Typical thermal resistance vs. power dissipation in the module (no heat sink) with 1oz FR4

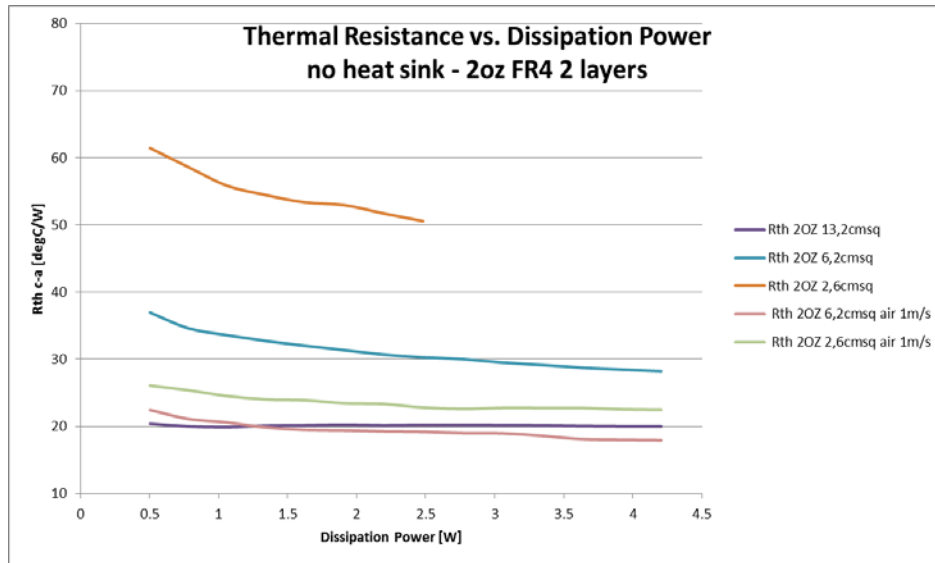


Figure 9 – Typical thermal resistance vs. power dissipation in the module (no heat sink) with 2oz FR4

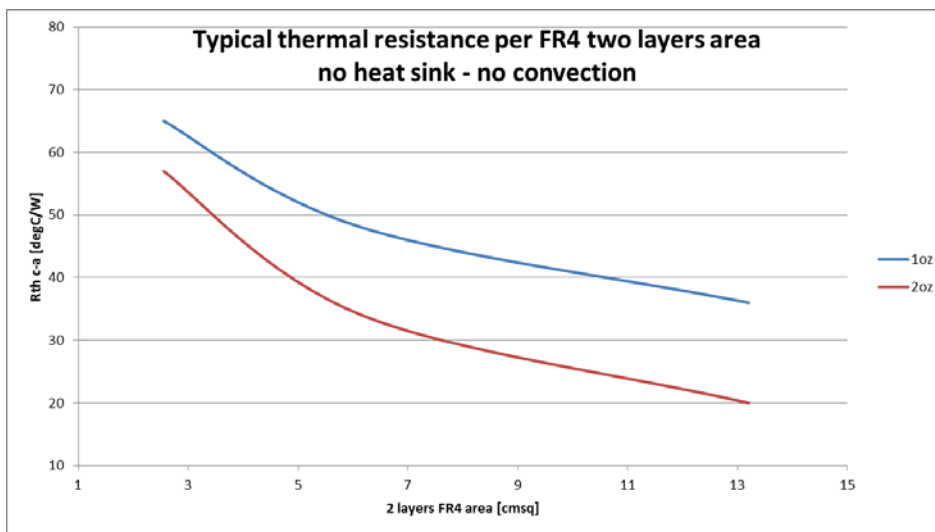


Figure 10 – Typical thermal resistance vs. area per module (no heat sink) with two layers FR4

### Qualification†

<b>Qualification Level</b>		Industrial <sup>††</sup> (per JEDEC JESD 47)
<b>Moisture Sensitivity Level</b>		MSL3 <sup>†††</sup> (per IPC/JEDEC J-STD-020)
<b>ESD</b>	Human Body Model	Class 1C (per JEDEC standard ANSI/ESDA/JEDEC JS-001)
	Machine Model	Class A (per EIA/JEDEC standard JESD22-A115)
<b>RoHS Compliant</b>		Yes

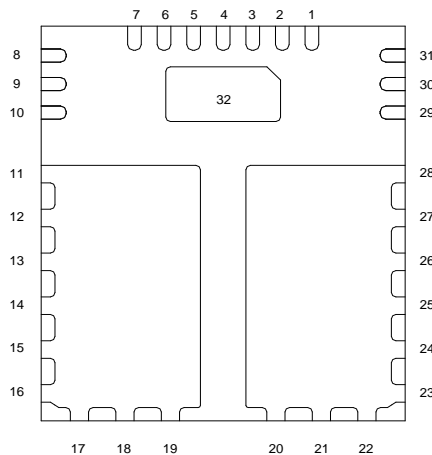
† Qualification standards can be found at International Rectifier's web site <http://www.irf.com/>

†† Higher qualification ratings may be available should the user have such requirements. Please contact your International Rectifier sales representative for further information.

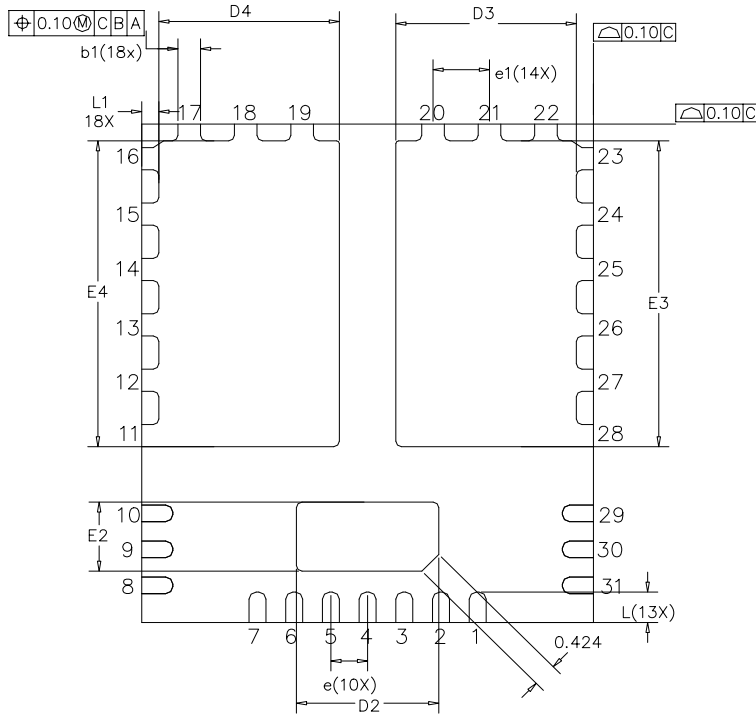
††† Higher MSL ratings may be available for the specific package types listed here. Please contact your International Rectifier sales representative for further information.

### Module Pin-Out Description

Pin	Name	Description
1, 4, 7, 32	COM	Low Side Gate Drive Return
2	VCC	15V Gate Drive Supply
3	HIN	Logic Input for High Side (Active High)
5	LIN	Logic Input for Low Side (Active High)
8, 9, 10	V-	Low Side Source Connection
11 – 19	VS	Phase Output
20 – 28	V+	DC Bus
29 – 30	VS	Phase Output (-ve Bootstrap Cap Connection)
31	VB	High Side Floating Supply (+ve Bootstrap Cap Connection)

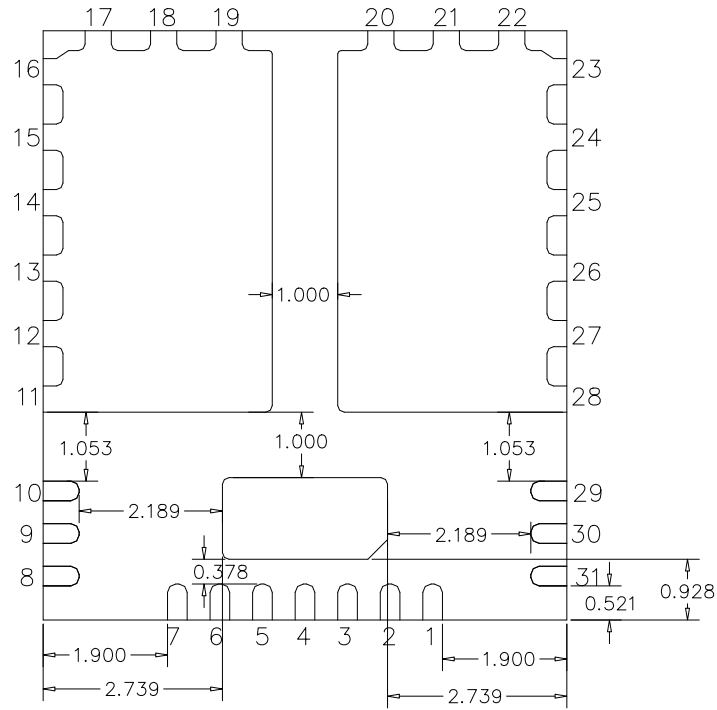


Exposed pad (Pin 32) has to be connected to COM for better electrical performance

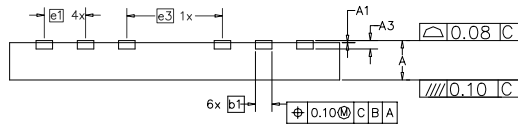
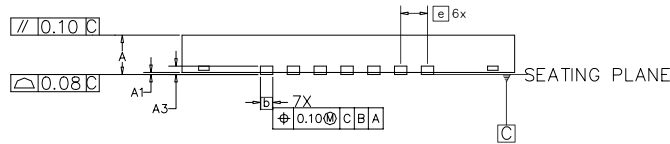
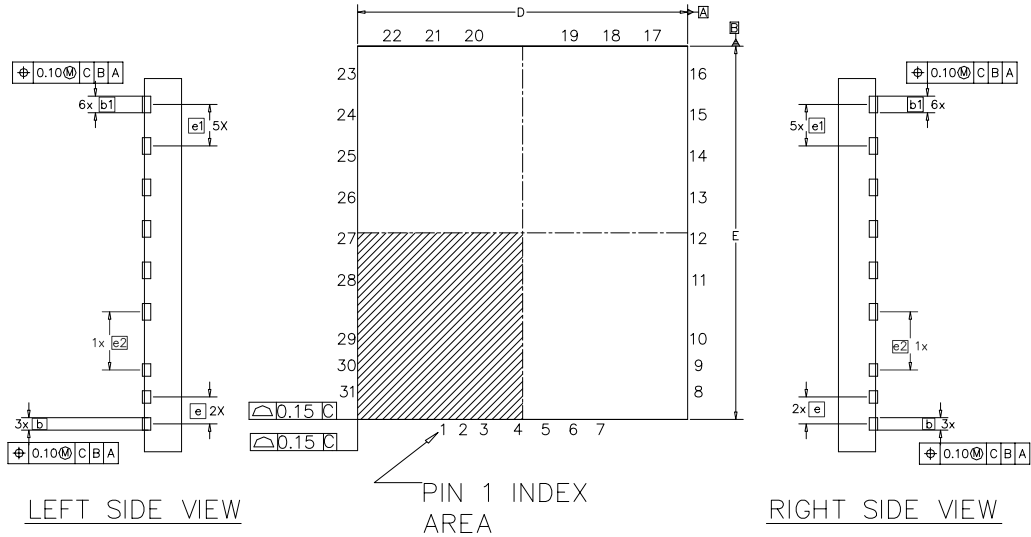
**Package Outline IRSM807-105MH (Bottom View), 1 of 2**


SYMBOL	DIMENSIONS IN MILLIMETER		
	MIN.	NOM.	MAX.
A	0.800	0.900	1.000
A1	0.000		0.050
A3	0.203 REF.		
b	0.250	0.300	0.350
b1	0.350	0.400	0.450
D	7.900	8.000	8.100
E	8.900	9.000	9.100
D2	2.472	2.522	2.572
E2	1.197	1.247	1.297
D3	3.147	3.197	3.247
E3	5.472	5.522	5.572
D4	3.147	3.197	3.247
E4	5.472	5.522	5.572
e	0.650 BSC		
e1	1.000 BSC		
e2	1.403 BSC		
e3	2.318 BSC		
L	0.500	0.550	0.600
L1	0.253	0.303	0.353

Dimensions in mm

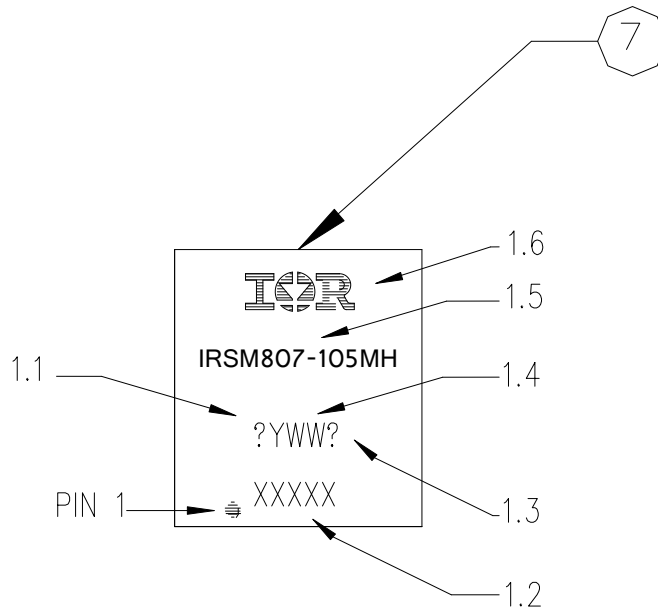
**Package Outline IRSM807-105MH (Bottom View), 2 of 2**


Dimensions in mm

**Package Outline IRSM807-105MH (Top & Side View)**
BACK SIDE VIEW

TOP VIEW

FRONT SIDE VIEW

SYMBOL	DIMENSIONS IN MILLIMETER						
	MIN.	NOM.	MAX.				
A	0.800	0.900	1.000	E2	1.197	1.247	1.297
A1	0.000		0.050	D3	3.147	3.197	3.247
A3	0.203 REF.			E3	5.472	5.522	5.572
b	0.250	0.300	0.350	D4	3.147	3.197	3.247
b1	0.350	0.400	0.450	E4	5.472	5.522	5.572
D	7.900	8.000	8.100	e	0.650 BSC		
E	8.900	9.000	9.100	e1	1.000 BSC		
D2	2.472	2.522	2.572	e2	1.403 BSC		
				e3	2.318 BSC		
				L	0.500	0.550	0.600
				L1	0.253	0.303	0.353

Dimensions in mm

**Top Marking**


TOP MARKING

- NOTES, MARKING:
- 1.1) SITE CODE: X
  - 1.2) LAST 4 CHARACTER OF SPN/NANA CODE: XXXX
  - 1.3) LEADFREE INDICATOR: P
  - 1.4) DATE CODE: YWW
  - 1.5) PART NUMBER: IRSM607-105MH
  - 1.6) IR LOGO
  - 1.7) MEDIUM:
    - 1.7.1) TOP: LASER
    - 1.7.2) BOTTOM: NONE

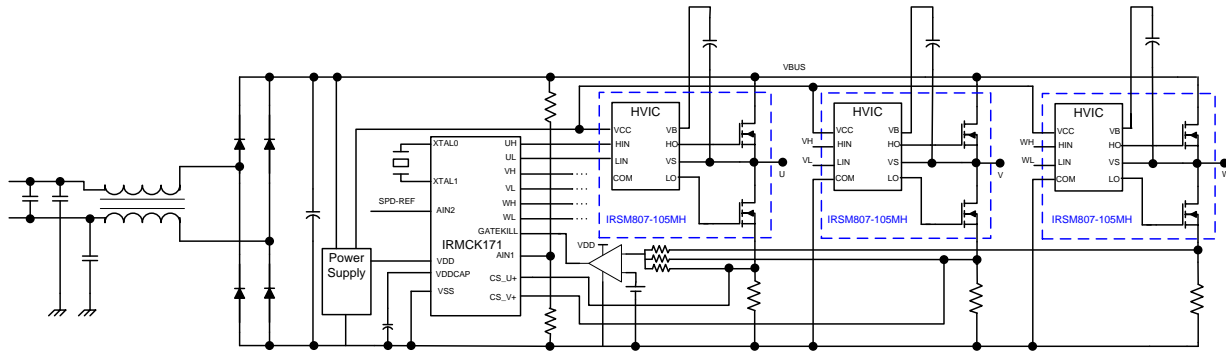
**Typical Application Connection IRS807-105MH**


Figure 1: Typical Application Connection

1. Bus capacitors should be mounted as close to the module bus terminals as possible to reduce ringing and EMI problems. Additional high frequency ceramic capacitor mounted close to the module pins will further improve performance.
2. In order to provide a good decoupling between VCC-VSS and VB-VS terminals, the capacitors shown connected at these terminals should be located very close to the module pins. Additional high frequency capacitors, typically 0.1uF, are recommended.
3. Value of the boot-strap capacitors depends upon the switching frequency. Their selection should be made based on IR Design tip DT04-4 or application note AN-1044.

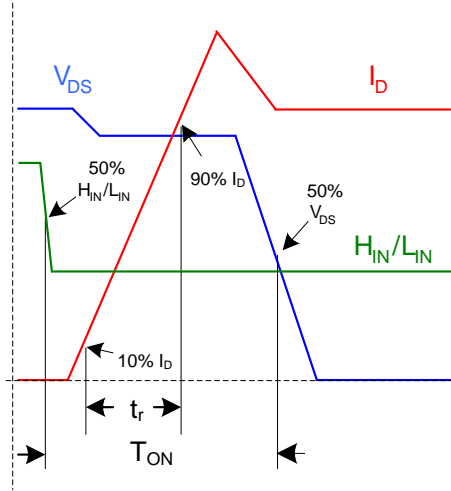


Figure 3a. Input to Output propagation turn-on delay time.

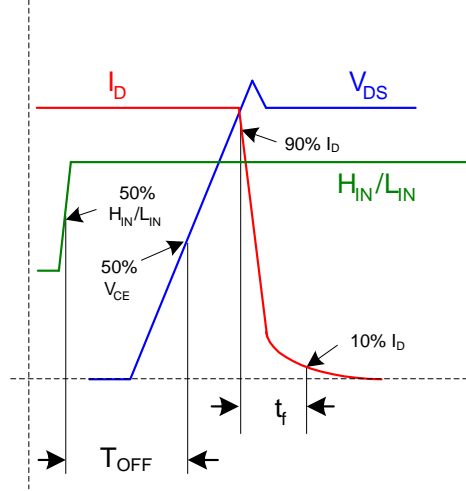


Figure 3b. Input to Output propagation turn-off delay time.

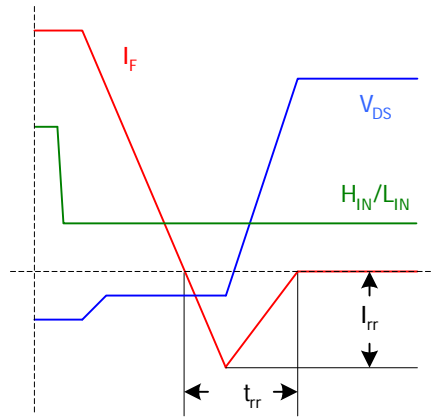


Figure 3c. Diode Reverse Recovery

International  
 Rectifier

Data and Specifications are subject to change without notice  
**IR WORLD HEADQUARTERS:** 233 Kansas St., El Segundo, California 90245, USA Tel: (310) 252-7105  
TAC Fax: (310) 252-7903  
Visit us at [www.irf.com](http://www.irf.com) for sales contact information