

## TABLE OF CONTENTS

Features .....	1	Addressing Registers .....	23
Applications .....	1	Conversion Result Register .....	24
Functional Block Diagram .....	1	Channel Register .....	25
General Description .....	1	Configuration Register .....	26
Revision History .....	2	Alert Indication Register .....	28
Specifications .....	3	Channel x Low Limit Register .....	30
Timing Specifications .....	5	Channel x High Limit Register .....	30
Absolute Maximum Ratings .....	7	Channel x Hysteresis Register .....	30
Thermal Resistance .....	7	Serial Port Interface .....	31
ESD Caution .....	7	Reading Conversion Result .....	31
Pin Configurations and Function Descriptions .....	8	Writing Data to the Registers .....	31
Typical Performance Characteristics .....	13	Reading Data from the Registers .....	31
Terminology .....	18	Power-On Device Initialization .....	33
Theory of Operation .....	19	Modes of Operation .....	34
Circuit Information .....	19	Normal Mode .....	34
Converter Operation .....	19	Power-Down Mode .....	34
ADC Transfer Function .....	19	ALERT (AD7091R-4 and AD7091R-8 Only) .....	35
Reference .....	19	BUSY (AD7091R-4 and AD7091R-8 Only) .....	35
Power Supply .....	20	Channel Sequencer .....	36
Device Reset .....	20	Daisy Chain .....	37
Typical Connection Diagram .....	20	Outline Dimensions .....	39
Analog Input .....	20	Ordering Guide .....	42
Driver Amplifier Choice .....	21		
Registers .....	23		

## REVISION HISTORY

<b>12/15—Rev. B to Rev. C</b>	
Change to the Reference Section .....	19
<b>11/14—Rev. A to Rev. B</b>	
Added Endnote 1 .....	3
Added Total Power Dissipation (Normal Mode) of 0.080 mW ...	4
Changes to Table 2 .....	5
Added Device Reset Section and Figure 43; Renumbered Sequentially .....	20
Added Power-On Device Initialization Section and Figure 53..	33
<b>7/14—Rev. 0 to Rev. A</b>	
Added 16-Lead LFCSP, 20-Lead LFCSP, and 24-Lead LFCSP .....	Universal
Changes to Features Section .....	1
Changes to General Description Section .....	1
Changes to Table 1 .....	3
Changes to Table 4 .....	7
Added Figure 6; Renumbered Sequentially .....	8
Changes to Table 5 .....	8
Added Figure 8 .....	9
Changes to Table 6 .....	9
Added Figure 10 .....	11
Changes to Table 7 .....	11
Added Power Supply Section and Table 8; Renumbered Sequentially .....	20
Added Driver Amplifier Choice Section and Table 9 .....	21
Changes to Table 16 .....	26
Changed Serial Interface Section to Serial Port Interface Section .....	31
Changes to Figure 52 .....	33
Updated Outline Dimensions .....	38
Changes to Ordering Guide .....	41
<b>12/13—Revision 0: Initial Version</b>	

## SPECIFICATIONS

$V_{DD} = 2.7 \text{ V to } 5.25 \text{ V}$ ,  $V_{DRIVE} = 1.8 \text{ V to } 5.25 \text{ V}$ ,  $V_{REF} = 2.5 \text{ V}$  internal reference,  $f_{SAMPLE} = 1 \text{ MSPS}$ ,  $f_{SCLK} = 50 \text{ MHz}$ ,  $T_A = T_{MIN}$  to  $T_{MAX}$ , unless otherwise noted.

Table 1.

Parameter	Test Conditions/Comments	Min	Typ	Max	Unit
<b>DYNAMIC PERFORMANCE</b>					
	$f_{IN} = 10 \text{ kHz sine wave}$				
Signal-to-Noise Ratio (SNR)		66.5	70		dB
Signal-to-Noise-and-Distortion (SINAD) Ratio		65.5	69		dB
Total Harmonic Distortion (THD)			-80		dB
Spurious-Free Dynamic Range (SFDR)	$f_{IN} = 1 \text{ kHz sine wave}$		-81		dB
Channel-to-Channel Isolation			-95		dB
Aperture Delay			5		ns
Aperture Jitter			40		ps
Full Power Bandwidth	At -3 dB		1.5		MHz
	At -0.1 dB		1.2		MHz
<b>DC ACCURACY</b>					
Resolution		12			Bits
Integral Nonlinearity (INL)	$V_{DD} \geq 3.0 \text{ V}$	-1	$\pm 0.7$	+1	LSB
	$V_{DD} \geq 2.7 \text{ V}$	-1.25	$\pm 0.8$	+1.25	LSB
Differential Nonlinearity (DNL)	Guaranteed no missing codes to 12 bits	-0.9	$\pm 0.3$	+0.9	LSB
Offset Error	$T_A = 25^\circ\text{C}$	-1.5	0.2	+1.5	mV
Offset Error Matching	$T_A = 25^\circ\text{C}$	-1.5	0.2	+1.5	mV
Offset Error Drift			2		ppm/ $^\circ\text{C}$
Gain Error	$T_A = 25^\circ\text{C}$	-0.1	0.0	+0.1	% FS
Gain Error Matching	$T_A = 25^\circ\text{C}$	-0.1	0.0	+0.1	% FS
Gain Error Drift			2		ppm/ $^\circ\text{C}$
<b>ANALOG INPUT</b>					
Input Voltage Range <sup>1</sup>	At $ADC_{IN}$	0		$V_{REF}$	V
DC Leakage Current		-1		+1	$\mu\text{A}$
Input Capacitance <sup>2</sup>	During acquisition phase		10		pF
	Outside acquisition phase		1.5		pF
Multiplexer On Resistance	$V_{DD} = 5.0 \text{ V}$		50		$\Omega$
	$V_{DD} = 2.5 \text{ V}$		100		$\Omega$
<b>VOLTAGE REFERENCE INPUT/OUTPUT</b>					
$REF_{OUT}^3$	Internal reference output, $T_A = 25^\circ\text{C}$	2.49	2.5	2.51	V
$REF_{IN}^3$	External reference input	1.0		$V_{DD}$	V
Drift			5		ppm/ $^\circ\text{C}$
Power-On Time	$C_{REF} = 2.2 \mu\text{F}$		50		ms
<b>LOGIC INPUTS</b>					
Input High Voltage ( $V_{IH}$ )		$0.7 \times V_{DRIVE}$			V
Input Low Voltage ( $V_{IL}$ )				$0.3 \times V_{DRIVE}$	V
Input Current ( $I_{IN}$ )	Typically 10 nA, $V_{IN} = 0 \text{ V or } V_{DRIVE}$	-1		+1	$\mu\text{A}$
<b>LOGIC OUTPUTS</b>					
Output High Voltage ( $V_{OH}$ )	$I_{SOURCE} = 200 \mu\text{A}$	$V_{DRIVE} - 0.2$			V
Output Low Voltage ( $V_{OL}$ )	$I_{SINK} = 200 \mu\text{A}$			0.4	V
Floating State Leakage Current		-1		+1	$\mu\text{A}$
Output Coding		Straight (natural) binary			

Parameter	Test Conditions/Comments	Min	Typ	Max	Unit
<b>CONVERSION RATE</b>					
Conversion Time	Full-scale step input			600	ns
Transient Response				400	ns
Throughput Rate				1	MSPS
<b>POWER REQUIREMENTS</b>					
$V_{DD}$		2.7		5.25	V
$V_{DRIVE}$	Specified performance	2.7		5.25	V
$V_{DRIVE}$ Range <sup>4</sup>	Functional	1.8		5.25	V
$I_{DD}$	$V_{IN} = 0\text{ V}$				
Normal Mode—Static <sup>5</sup>	$V_{DD} = 5.25\text{ V}$		22	50	$\mu\text{A}$
	$V_{DD} = 3\text{ V}$		21.6	46	$\mu\text{A}$
Normal Mode—Operational	$V_{DD} = 5.25\text{ V}, f_{SAMPLE} = 1\text{ MSPS}$		500	570	$\mu\text{A}$
	$V_{DD} = 3\text{ V}, f_{SAMPLE} = 1\text{ MSPS}$		450	530	$\mu\text{A}$
Power-Down Mode	$V_{DD} = 5.25\text{ V}$		0.550	17	$\mu\text{A}$
	$V_{DD} = 5.25\text{ V}, T_A = -40^\circ\text{C to } +85^\circ\text{C}$		0.550	6	$\mu\text{A}$
	$V_{DD} = 3\text{ V}$		0.435	15	$\mu\text{A}$
$I_{DRIVE}$	$V_{IN} = 0\text{ V}$				
Normal Mode—Static <sup>6</sup>	$V_{DRIVE} = 5.25\text{ V}$		2	4	$\mu\text{A}$
	$V_{DRIVE} = 3\text{ V}$		1	3.5	$\mu\text{A}$
Normal Mode—Operational	$V_{DRIVE} = 5.25\text{ V}, f_{SAMPLE} = 1\text{ MSPS}$		30	70	$\mu\text{A}$
	$V_{DRIVE} = 3\text{ V}, f_{SAMPLE} = 1\text{ MSPS}$		10	15	$\mu\text{A}$
Power-Down Mode	$V_{DRIVE} = 5.25\text{ V}$			1	$\mu\text{A}$
	$V_{DRIVE} = 3\text{ V}$			1	$\mu\text{A}$
<b>Total Power Dissipation<sup>7</sup></b>					
Normal Mode—Static	$V_{IN} = 0\text{ V}$				
	$V_{DD} = V_{DRIVE} = 5.25\text{ V}$		0.130	0.290	mW
Normal Mode—Operational	$V_{DD} = V_{DRIVE} = 3\text{ V}$		0.070	0.149	mW
	$V_{DD} = V_{DRIVE} = 5.25\text{ V}, f_{SAMPLE} = 1\text{ MSPS}$		2.8	3.4	mW
	$V_{DD} = V_{DRIVE} = 3\text{ V}, f_{SAMPLE} = 1\text{ MSPS}$		1.4	1.7	mW
	$V_{DD} = V_{DRIVE} = 3\text{ V}, f_{SAMPLE} = 100\text{ SPS}$		0.080		mW
Power-Down Mode	$V_{DD} = 5.25\text{ V}$		3	95	$\mu\text{W}$
	$V_{DD} = 5.25\text{ V}, T_A = -40^\circ\text{C to } +85^\circ\text{C}$		3	33	$\mu\text{W}$
	$V_{DD} = V_{DRIVE} = 3\text{ V}$		1.4	50	$\mu\text{W}$

<sup>1</sup> Multiplexer input voltage should not exceed  $V_{DD}$ .

<sup>2</sup> Sample tested during initial release to ensure compliance.

<sup>3</sup> When referring to a single function of a multifunction pin in the parameters, only the portion of the pin name that is relevant to the specification is listed. For full pin names of multifunction pins, refer to the Pin Configurations and Function Descriptions section.

<sup>4</sup> Device is functional and meets dynamic performance/dc accuracy specifications with  $V_{DRIVE}$  down to 1.8 V, but the device is not capable of achieving a throughput of 1 MSPS.

<sup>5</sup> SCLK operates in burst mode, and  $\overline{CS}$  idles high. With a free running SCLK and  $\overline{CS}$  pulled low, the  $I_{DD}$  static current is increased by 30  $\mu\text{A}$  typical at  $V_{DD} = 5.25\text{ V}$ .

<sup>6</sup> SCLK operates in burst mode, and  $\overline{CS}$  idles high. With a free running SCLK and  $\overline{CS}$  pulled low, the  $I_{DRIVE}$  static current is increased by 32  $\mu\text{A}$  typical at  $V_{DRIVE} = 5.25\text{ V}$ .

<sup>7</sup> Total power dissipation includes contributions from  $V_{DD}$ ,  $V_{DRIVE}$ , and  $REF_{IN}$  (see Note 2).

**TIMING SPECIFICATIONS**

$V_{DD} = 2.7\text{ V to } 5.25\text{ V}$ ,  $V_{DRIVE} = 1.8\text{ V to } 5.25\text{ V}$ ,  $T_A = T_{MIN}$  to  $T_{MAX}$ , unless otherwise noted.

**Table 2.**

Parameter	Symbol	Min	Typ	Max	Unit
Conversion Time: $\overline{\text{CONVST}}$ Falling Edge to Data Available	$t_{\text{CONVERT}}$			600	ns
Acquisition Time	$t_{\text{ACQ}}$	400			ns
Time Between Conversions (Normal Mode)	$t_{\text{CYC}}$	1000			ns
$\overline{\text{CONVST}}$ Pulse Width	$t_{\text{CNVPW}}$	10		500	ns
SCLK Period (Normal Mode)	$t_{\text{SCLK}}$				
$V_{DRIVE}$ Above 2.7 V		16			ns
$V_{DRIVE}$ Above 1.8 V		22			ns
SCLK Period (Chain Mode)	$t_{\text{SCLK}}$				
$V_{DRIVE}$ Above 2.7 V		20			ns
$V_{DRIVE}$ Above 1.8 V		25			ns
SCLK Low Time	$t_{\text{SCLKL}}$	6			ns
SCLK High Time	$t_{\text{SCLKH}}$	6			ns
SCLK Falling Edge to Data Remains Valid	$t_{\text{HSDO}}$	5			ns
SCLK Falling Edge to Data Valid Delay	$t_{\text{DSDO}}$				
$V_{DRIVE}$ Above 4.5 V				12	ns
$V_{DRIVE}$ Above 3.3 V				13	ns
$V_{DRIVE}$ Above 2.7 V				14	ns
$V_{DRIVE}$ Above 1.8 V				20	ns
End of Conversion to $\overline{\text{CS}}$ Falling Edge	$t_{\text{EOCCSL}}$	5			ns
$\overline{\text{CS}}$ Low to SDO Enabled	$t_{\text{EN}}$			5	ns
$\overline{\text{CS}}$ High or Last SCLK Falling Edge to SDO High Impedance	$t_{\text{DIS}}$			5	ns
SDI Data Setup Time Prior to SCLK Rising Edge	$t_{\text{SSDISCLK}}$	5			ns
SDI Data Hold Time After SCLK Rising Edge	$t_{\text{HSDISCLK}}$	2			ns
Last SCLK Falling Edge to Next $\overline{\text{CONVST}}$ Falling Edge	$t_{\text{QUIET}}$	50			ns
$\overline{\text{RESET}}$ Pulse Width	$t_{\text{RESETPW}}$	10			ns
$\overline{\text{RESET}}$ Pulse Delay Upon Power Up	$t_{\text{RESET\_DELAY}}$	50			ns
Time Between Conversions (Power On Software Reset)	$t_{\text{CYC\_RESET}}$	2			$\mu\text{s}$

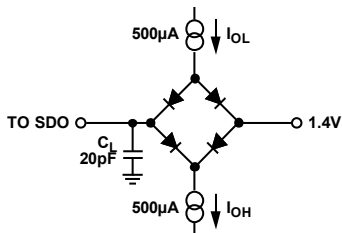
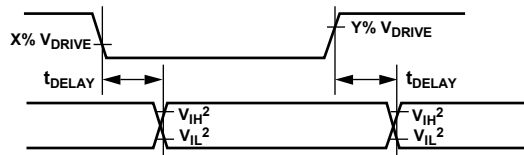

Figure 2. Load Circuit for Digital Interface Timing



**NOTES**  
 1 FOR  $V_{DRIVE} \leq 3.0\text{V}$ ,  $X = 90$  AND  $Y = 10$ ; FOR  $V_{DRIVE} > 3.0\text{V}$ ,  $X = 70$  AND  $Y = 30$ .  
 2 MINIMUM  $V_{IH}^2$  AND MAXIMUM  $V_{IL}^2$  USED. SEE SPECIFICATIONS FOR DIGITAL INPUTS PARAMETER IN TABLE 2.

Figure 3. Voltage Levels for Timing

Timing Diagram

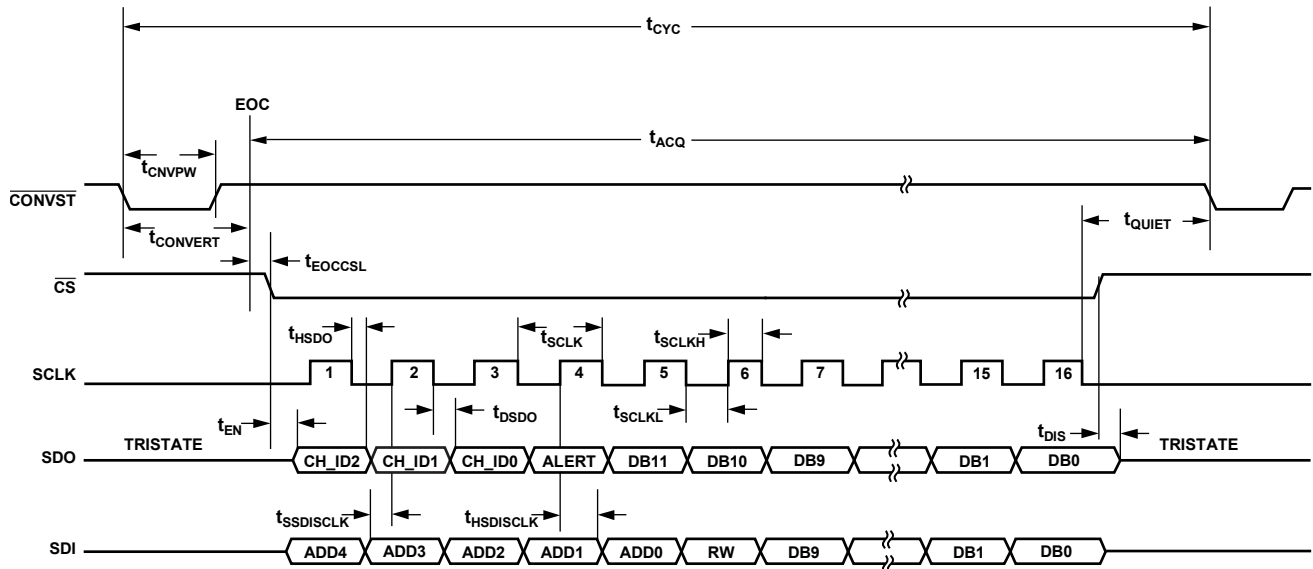

Figure 4. Serial Port Timing

10891-002

## ABSOLUTE MAXIMUM RATINGS

$T_A = 25^\circ\text{C}$ , unless otherwise noted.

Table 3.

Parameter	Rating
$V_{DD}$ to GND	-0.3 V to +7 V
$V_{DRIVE}$ to GND	-0.3 V to +7 V
Analog Input Voltage to GND	-0.3 V to $V_{REF} + 0.3$ V
Digital Input <sup>1</sup> Voltage to GND	-0.3 V to $V_{DRIVE} + 0.3$ V
Digital Output <sup>2</sup> Voltage to GND	-0.3 V to $V_{DRIVE} + 0.3$ V
Input Current to Any Pin Except Supplies <sup>3</sup>	$\pm 10$ mA
Operating Temperature Range	-40°C to +125°C
Storage Temperature Range	-65°C to +150°C
Junction Temperature	150°C
ESD	
Human Body Model (HBM)	1.5 kV
Field Induced Charged Device Model (FICDM)	500 V

<sup>1</sup> The digital input pins include the following:  $\overline{\text{RESET}}$ ,  $\overline{\text{CONVST}}$ , SDI, SCLK, and  $\overline{\text{CS}}$ .

<sup>2</sup> The digital output pins include the following: SDO, GPO<sub>1</sub>, and ALERT/BUSY/GPO<sub>0</sub>.

<sup>3</sup> Transient currents of up to 100 mA do not cause SCR latch-up.

Stresses above those listed under Absolute Maximum Ratings may cause permanent damage to the device. This is a stress rating only; functional operation of the device at these or any other conditions above those indicated in the operational section of this specification is not implied. Exposure to absolute maximum rating conditions for extended periods may affect device reliability.

## THERMAL RESISTANCE

$\theta_{JA}$  is specified for the worst-case conditions, that is, a device soldered in a circuit board for surface-mount packages.

Table 4. Thermal Resistance

Package Type	$\theta_{JA}$	$\theta_{JC}$	Unit
24-Lead LFCSP	47.3	27.78	$^\circ\text{C}/\text{W}$
24-Lead TSSOP	73.54	14.94	$^\circ\text{C}/\text{W}$
20-Lead LFCSP	49.05	29.18	$^\circ\text{C}/\text{W}$
20-Lead TSSOP	84.29	18.43	$^\circ\text{C}/\text{W}$
16-Lead LFCSP	50.58	29.64	$^\circ\text{C}/\text{W}$
16-Lead TSSOP	106.03	28.31	$^\circ\text{C}/\text{W}$

## ESD CAUTION



**ESD (electrostatic discharge) sensitive device.** Charged devices and circuit boards can discharge without detection. Although this product features patented or proprietary protection circuitry, damage may occur on devices subjected to high energy ESD. Therefore, proper ESD precautions should be taken to avoid performance degradation or loss of functionality.

PIN CONFIGURATIONS AND FUNCTION DESCRIPTIONS

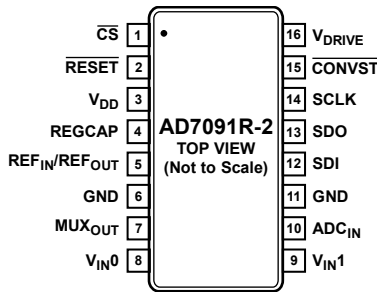
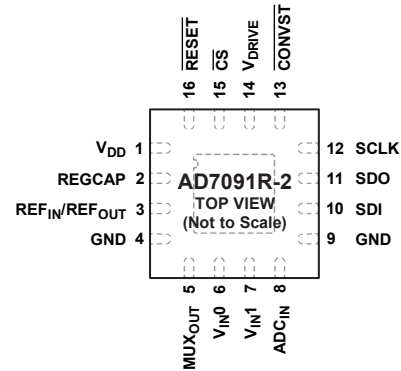

Figure 5. 2-Channel, 16-Lead TSSOP Pin Configuration



NOTES  
 1. THE EXPOSED PAD IS NOT CONNECTED INTERNALLY. IT IS RECOMMENDED THAT THE PAD BE SOLDERED TO GND.

Figure 6. 2-Channel, 16-Lead LFCSP Pin Configuration

Table 5. 2-Channel, 16-Lead LFCSP and 16-Lead TSSOP Pin Function Descriptions

Pin No.		Mnemonic	Description
TSSOP	LFCSP		
1	15	CS	Chip Select Input. When CS is held low, the serial bus enables, and CS frames the output data on the SPI.
2	16	RESET	Reset. Logic input.
3	1	V <sub>DD</sub>	Power Supply Input. The V <sub>DD</sub> range is from 2.7 V to 5.25 V. Decouple this supply pin to GND.
4	2	REGCAP	Decoupling Capacitor Pin for Voltage Output from Internal Regulator. Decouple this output pin separately to GND using a 1.0 μF capacitor.
5	3	REF <sub>IN</sub> /REF <sub>OUT</sub>	Voltage Reference Output, 2.5 V. Decouple this pin to GND. Typical recommended decoupling capacitor value is 2.2 μF. The user can either access the internal 2.5 V reference or overdrive the internal reference with the voltage applied to this pin. The reference voltage range for an externally applied reference is 1.0 V to V <sub>DD</sub> .
6, 11	4, 9	GND	Chip Ground Pins. These pins are the ground reference point for all circuitry on the AD7091R-2.
7	5	MUX <sub>OUT</sub>	Multiplexer Output. The output of the multiplexer appears at this pin. If no external filtering or buffering is required, tie this pin directly to the ADC <sub>IN</sub> pin; otherwise, tie the output of the conditioning network to the ADC <sub>IN</sub> pin.
8	6	V <sub>IN0</sub>	Analog Input 0. Single-ended analog input. The analog input range is 0 V to V <sub>REF</sub> .
9	7	V <sub>IN1</sub>	Analog Input 1. Single-ended analog input. The analog input range is 0 V to V <sub>REF</sub> .
10	8	ADC <sub>IN</sub>	ADC Input. This pin allows access to the on-chip track-and-hold. If no external filtering or buffering is required, tie this pin directly to the MUX <sub>OUT</sub> pin; otherwise tie the input of the conditioning network to the MUX <sub>OUT</sub> pin.
12	10	SDI	Serial Data Input Bus. This input provides the data written to the on-chip control registers. Data clocks into the registers on the falling edge of the SCLK input. Provide data MSBs first.
13	11	SDO	Serial Data Output Bus. The conversion output data is supplied to this pin as a serial data stream. The bits are clocked out on the falling edge of the SCLK input, and 13 SCLKs are required to access the data. The data is provided MSB first.
14	12	SCLK	Serial Clock. This pin acts as the serial clock input.
15	13	CONVST	Convert Start Input Signal. Edge triggered logic input. The falling edge of CONVST places the track-and-hold mode into hold mode and initiates a conversion.
16	14	V <sub>DRIVE</sub>	Logic Power Supply Input. The voltage supplied at this pin determines at what voltage the interface operates. Connect decoupling capacitors between V <sub>DRIVE</sub> and GND. Typical recommended values are 10 μF and 0.1 μF. The voltage range on this pin is 1.8 V to 5.25 V and may be different to the voltage range at V <sub>DD</sub> .
Not applicable	17	EPAD	Exposed Pad. The exposed pad is not connected internally. It is recommended that the pad be soldered to GND.

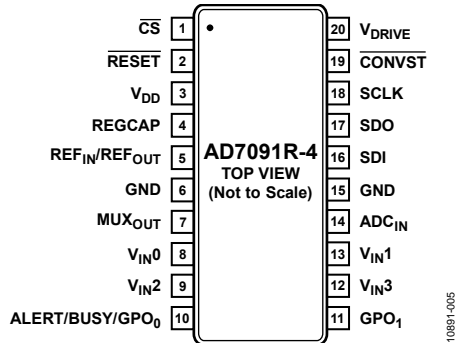

Figure 7. 4-Channel, 20-Lead TSSOP Pin Configuration

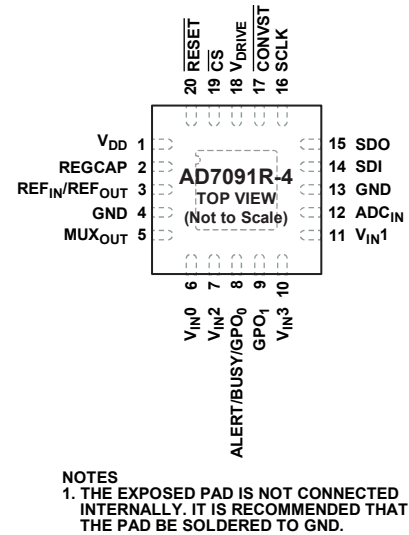

Figure 8. 4-Channel, 20-Lead LFCSP Pin Configuration

Table 6. 4-Channel, 20-Lead LFCSP and 20-Lead TSSOP Pin Function Descriptions

Pin No.		Mnemonic	Description
TSSOP	LFCSP		
1	19	$\overline{CS}$	Chip Select Input. When $\overline{CS}$ is held low, the serial bus enables, and $\overline{CS}$ frames the output data on the SPI.
2	20	$\overline{RESET}$	Reset. Logic input.
3	1	$V_{DD}$	Power Supply Input. The $V_{DD}$ range is from 2.7 V to 5.25 V. Decouple this supply pin to GND.
4	2	REGCAP	Decoupling Capacitor Pin for Voltage Output from Internal Regulator. Decouple this output pin separately to GND using a 1.0 $\mu$ F capacitor.
5	3	REF <sub>IN</sub> /REF <sub>OUT</sub>	Voltage Reference Output, 2.5 V. Decouple this pin to GND. Typical recommended decoupling capacitor value is 2.2 $\mu$ F. The user can either access the internal 2.5 V reference or overdrive the internal reference with the voltage applied to this pin. The reference voltage range for an externally applied reference is 1.0 V to $V_{DD}$ .
6, 15	4, 13	GND	Chip Ground Pins. These pins are the ground reference point for all circuitry on the AD7091R-4.
7	5	MUX <sub>OUT</sub>	Multiplexer Output. The output of the multiplexer appears at this pin. If no external filtering or buffering is required, tie this pin directly to the ADC <sub>IN</sub> pin; otherwise, tie the output of the conditioning network to the ADC <sub>IN</sub> pin.
8	6	V <sub>IN0</sub>	Analog Input 0. Single-ended analog input. The analog input range is 0 V to $V_{REF}$ .
9	7	V <sub>IN2</sub>	Analog Input 2. Single-ended analog input. The analog input range is 0 V to $V_{REF}$ .
10	8	ALERT/BUSY/GPO <sub>0</sub>	Alert Output Pin (ALERT). This is a multifunction pin determined by the configuration register. When functioning as ALERT, this pin is a logic output indicating that a conversion result has fallen outside the limit of the register settings. When the ALERT/BUSY/GPO <sub>0</sub> pin is configured as a BUSY output, use this pin to indicate when a conversion is taking place. The pin can also function as a general-purpose digital output.
11	9	GPO <sub>1</sub>	General-Purpose Digital Output.
12	10	V <sub>IN3</sub>	Analog Input 3. Single-ended analog input. The analog input range is 0 V to $V_{REF}$ .
13	11	V <sub>IN1</sub>	Analog Input 1. Single-ended analog input. The analog input range is 0 V to $V_{REF}$ .
14	12	ADC <sub>IN</sub>	ADC Input. This pin allows access to the on-chip track-and-hold. If no external filtering or buffering is required, tie this pin directly to the MUX <sub>OUT</sub> pin; otherwise, tie the input of the conditioning network to the MUX <sub>OUT</sub> pin.
16	14	SDI	Serial Data Input Bus. This input provides data written to the on-chip control registers. Data clocks into the registers on the falling edge of the SCLK input. Provide data MSB first.
17	15	SDO	Serial Data Output Bus. The conversion output data is supplied to this pin as a serial data stream. The bits are clocked out on the falling edge of the SCLK input, and 13 SCLKs are required to access the data. The data is provided MSB first.



Pin No.		Mnemonic	Description
TSSOP	LFCSP		
18	16	SCLK	Serial Clock. This pin acts as the serial clock input.
19	17	$\overline{\text{CONVST}}$	Convert Start Input Signal. Edge triggered logic input. The falling edge of $\overline{\text{CONVST}}$ places the track-and-hold mode into hold mode and initiates a conversion.
20	18	V <sub>DRIVE</sub>	Logic Power Supply Input. The voltage supplied at this pin determines at what voltage the interface operates. Connect decoupling capacitors between V <sub>DRIVE</sub> and GND. Typical recommended values are 10 $\mu\text{F}$ and 0.1 $\mu\text{F}$ . The voltage range on this pin is 1.8 V to 5.25 V and may be different to the voltage range at V <sub>DD</sub> .
Not applicable	21	EPAD	Exposed Pad. The exposed pad is not connected internally. It is recommended that the pad be soldered to GND.

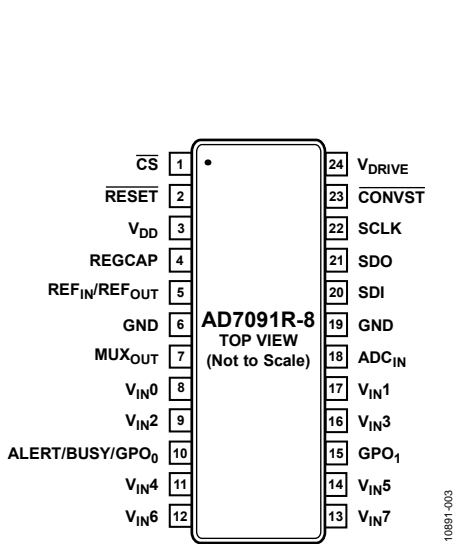
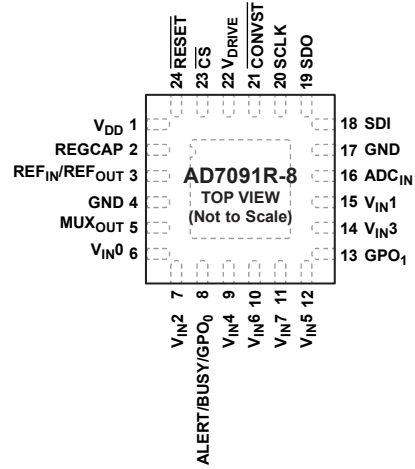

Figure 9. 8-Channel, 24-Lead TSSOP Pin Configuration



NOTES  
 1. THE EXPOSED PAD IS NOT CONNECTED INTERNALLY. IT IS RECOMMENDED THAT THE PAD BE SOLDERED TO GND.

Figure 10. 8-Channel, 24-Lead LFCSP Pin Configuration

Table 7. 8-Channel, 24-Lead LFCSP and 24-Lead TSSOP Pin Function Descriptions

Pin No.		Mnemonic	Description
TSSOP	LFCSP		
1	23	CS	Chip Select Input. When CS is held low, the serial bus enables, and CS frames the output data on the SPI.
2	24	RESET	Reset. Logic input.
3	1	V <sub>DD</sub>	Power Supply Input. The V <sub>DD</sub> range is from 2.7 V to 5.25 V. Decouple this supply pin to GND.
4	2	REGCAP	Decoupling Capacitor Pin for Voltage Output from Internal Regulator. Decouple this output pin separately to GND using a 1.0 μF capacitor.
5	3	REF <sub>IN</sub> /REF <sub>OUT</sub>	Voltage Reference Output, 2.5 V. Decouple this pin to GND. Typical recommended decoupling capacitor value is 2.2 μF. The user can either access the internal 2.5 V reference or overdrive the internal reference with the voltage applied to this pin. The reference voltage range for an externally applied reference is 1.0 V to V <sub>DD</sub> .
6, 19	4, 17	GND	Chip Ground Pins. These pins are the ground reference point for all circuitry on the AD7091R-8.
7	5	MUX <sub>OUT</sub>	Multiplexer Output. The output of the multiplexer appears at this pin. If no external filtering or buffering is required, tie this pin directly to the ADC <sub>IN</sub> pin; otherwise, tie the output of the conditioning network to the ADC <sub>IN</sub> pin.
8	6	V <sub>IN0</sub>	Analog Input 0. Single-ended analog input. The analog input range is 0 V to V <sub>REF</sub> .
9	7	V <sub>IN2</sub>	Analog Input 2. Single-ended analog input. The analog input range is 0 V to V <sub>REF</sub> .
10	8	ALERT/BUSY/GPO <sub>0</sub>	Alert Output Pin (ALERT). This is a multifunction pin determined by the configuration register. When functioning as ALERT, this pin is a logic output indicating that a conversion result has fallen outside the limit of the register settings. When the ALERT/BUSY/GPO <sub>0</sub> pin is configured as a BUSY output, use this pin to indicate when a conversion is taking place. The pin can also function as a general-purpose digital output.
11	9	V <sub>IN4</sub>	Analog Input 4. Single-ended analog input. The analog input range is 0 V to V <sub>REF</sub> .
12	10	V <sub>IN6</sub>	Analog Input 6. Single-ended analog input. The analog input range is 0 V to V <sub>REF</sub> .
13	11	V <sub>IN7</sub>	Analog Input 7. Single-ended analog input. The analog input range is 0 V to V <sub>REF</sub> .
14	12	V <sub>IN5</sub>	Analog Input 5. Single-ended analog input. The analog input range is 0 V to V <sub>REF</sub> .
15	13	GPO <sub>1</sub>	General-Purpose Digital Output.
16	14	V <sub>IN3</sub>	Analog Input 3. Single-ended analog input. The analog input range is 0 V to V <sub>REF</sub> .
17	15	V <sub>IN1</sub>	Analog Input 1. Single-ended analog input. The analog input range is 0 V to V <sub>REF</sub> .
18	16	ADC <sub>IN</sub>	ADC Input. This pin allows access to the on-chip track-and-hold. If no external filtering or buffering is required, tie this pin directly to the MUX <sub>OUT</sub> pin; otherwise, tie the input of the conditioning network to the MUX <sub>OUT</sub> pin.

Pin No.		Mnemonic	Description
TSSOP	LFCSP		
20	18	SDI	Serial Data Input Bus. Data to be written to the on-chip control registers is provided on this input. Data is clocked into the registers on the falling edge of the SCLK input. Provide data MSB first.
21	19	SDO	Serial Data Output Bus. The conversion output data is supplied to this pin as a serial data stream. The bits are clocked out on the falling edge of the SCLK input, and 13 SCLKs are required to access the data. The data is provided MSB first.
22	20	SCLK	Serial Clock. This pin acts as the serial clock input.
23	21	$\overline{\text{CONVST}}$	Convert Start Input Signal. Edge triggered logic input. The falling edge of $\overline{\text{CONVST}}$ places the track-and-hold mode into hold mode and initiates a conversion.
24	22	V <sub>DRIVE</sub>	Logic Power Supply Input. The voltage supplied at this pin determines at what voltage the interface operates. Connect decoupling capacitors between V <sub>DRIVE</sub> and GND. Typical recommended values are 10 $\mu\text{F}$ and 0.1 $\mu\text{F}$ . The voltage range on this pin is 1.8 V to 5.25 V and may be different to the voltage range at V <sub>DD</sub> .
Not applicable	25	EPAD	Exposed Pad. The exposed pad is not connected internally. It is recommended that the pad be soldered to GND.

TYPICAL PERFORMANCE CHARACTERISTICS

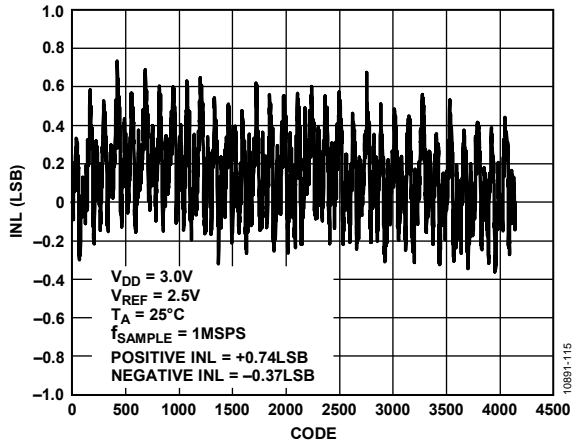

Figure 11. Integral Nonlinearity vs. Code

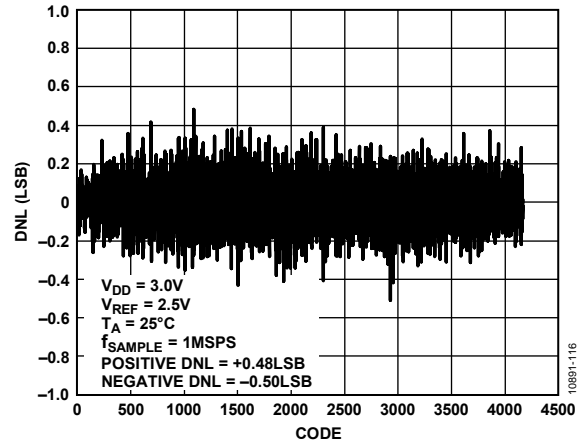

Figure 14. Differential Nonlinearity vs. Code

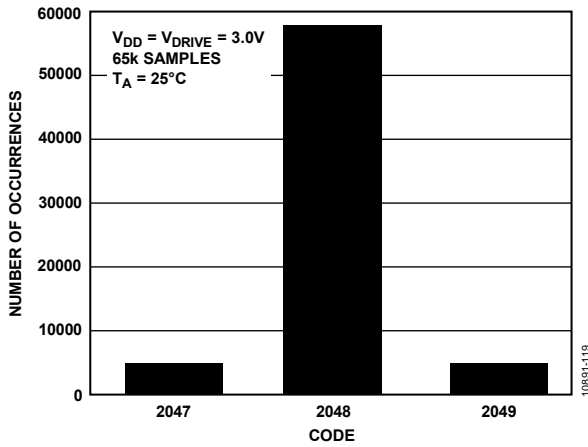

Figure 12. Histogram of a DC Input at Code Center

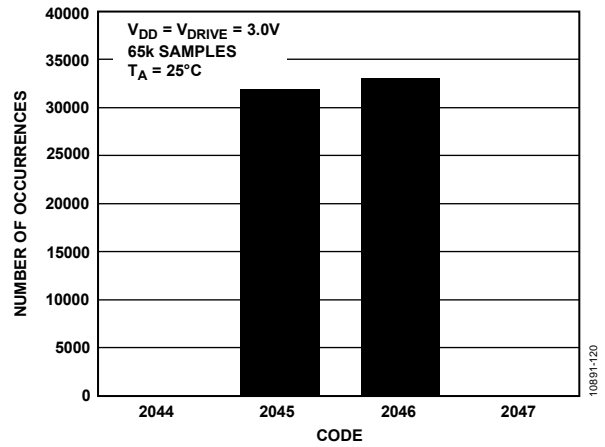

Figure 15. Histogram of a DC Input at Code Transition

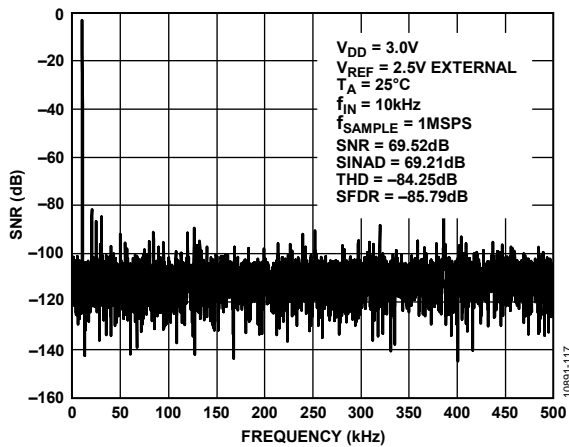

Figure 13. 10 kHz Fast Fourier Transform (FFT),  $V_{DD} = 3.0V$ ,  $V_{REF} = 2.5V$  External

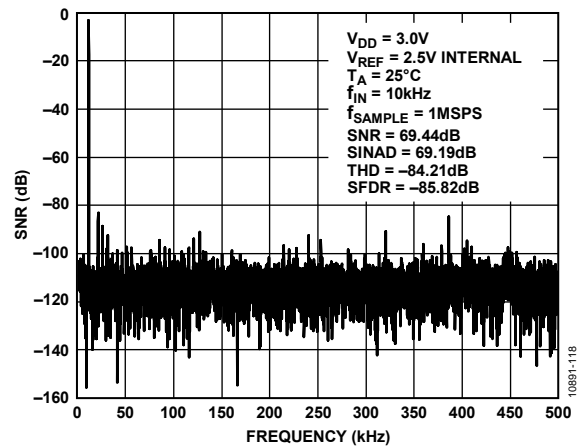

Figure 16. 10 kHz FFT,  $V_{DD} = 3.0V$ ,  $V_{REF} = 2.5V$  Internal

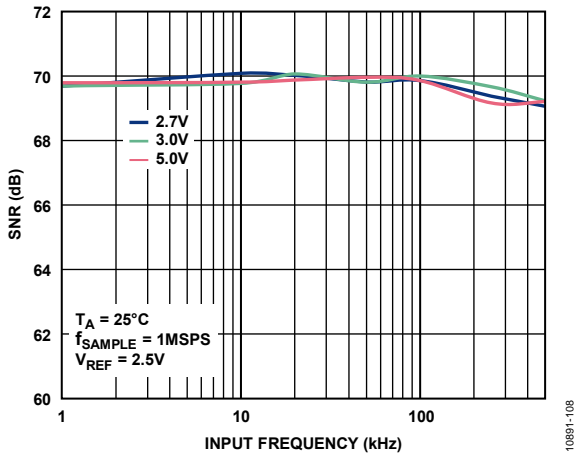

Figure 17. SNR vs. Analog Input Frequency for Various Supply Voltages

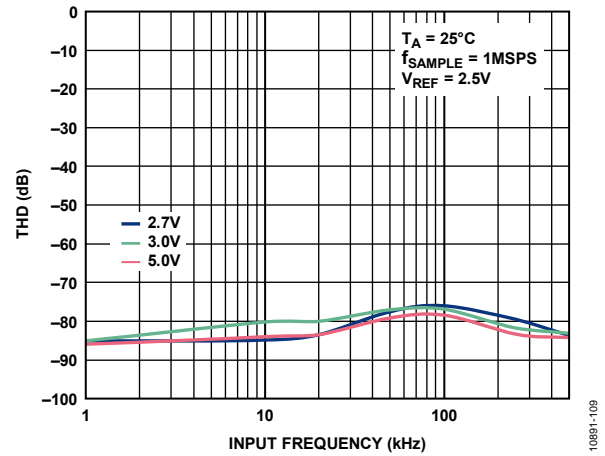

Figure 20. THD vs. Analog Input Frequency for Various Supply Voltages

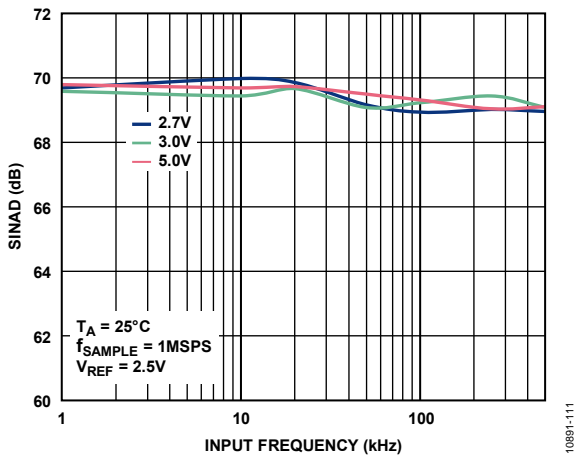

Figure 18. SINAD vs. Analog Input Frequency for Various Supply Voltages

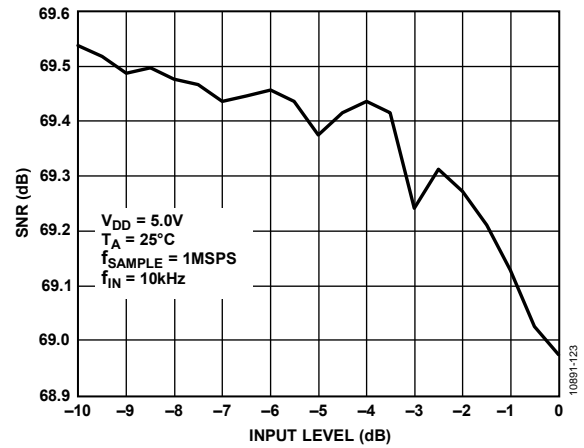

Figure 21. SNR vs. Input Level

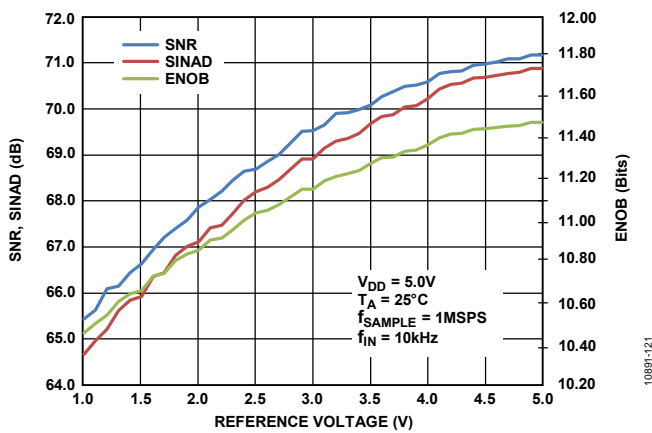

Figure 19. SNR, SINAD, and ENOB vs. Reference Voltage

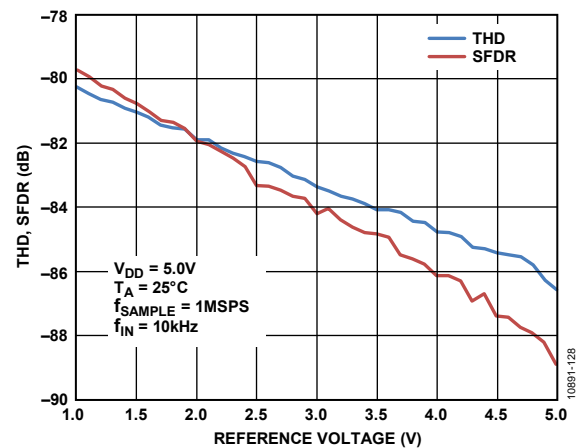

Figure 22. THD and SFDR vs. Reference Voltage

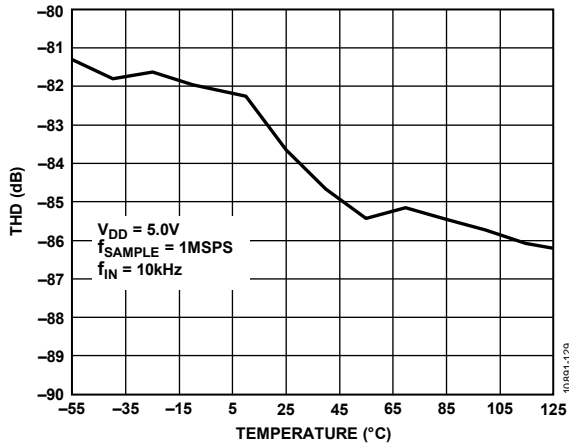

Figure 23. THD vs. Temperature

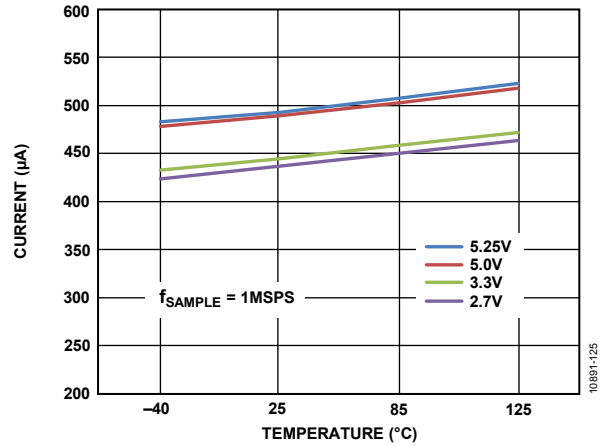

Figure 26. Operational  $I_{DD}$  Supply Current vs. Temperature for Various  $V_{DD}$  Supply Voltages

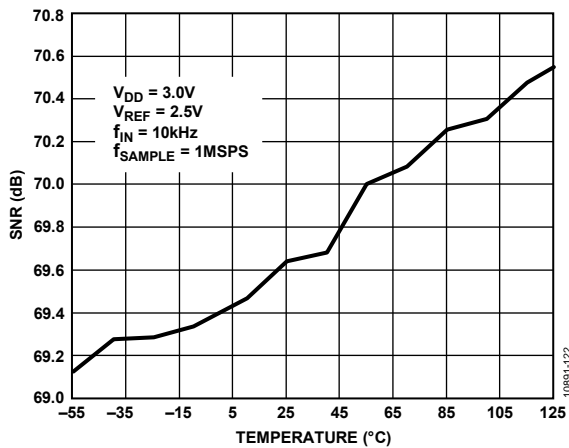

Figure 24. SNR vs. Temperature

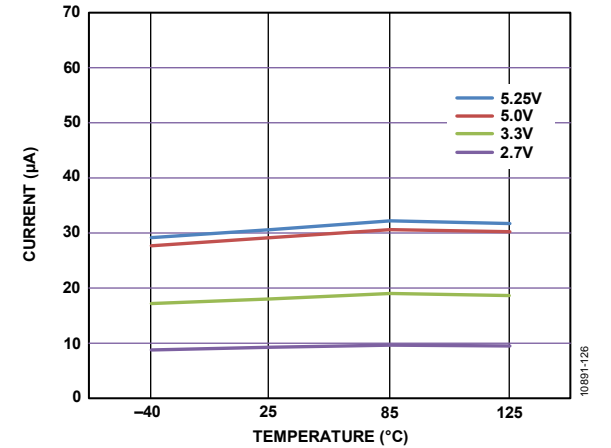

Figure 27. Operational  $I_{DRIVE}$  Supply Current vs. Temperature for Various  $V_{DRIVE}$  Supply Voltages

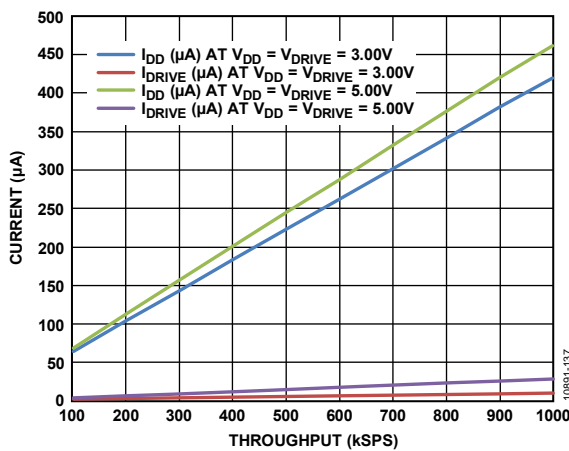

Figure 25. Operating Current vs. Throughput

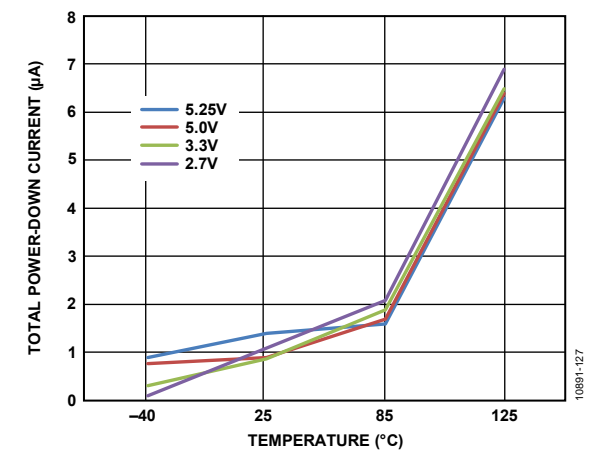

Figure 28. Total Power-Down Current vs. Temperature for Various Supplies

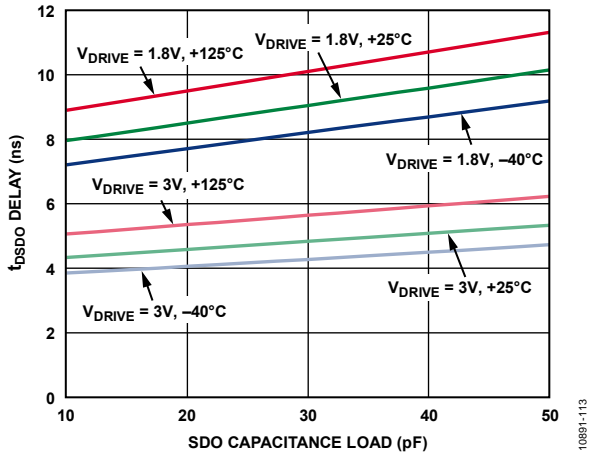

Figure 29.  $t_{SDO}$  Delay vs. SDO Capacitance Load and Supply

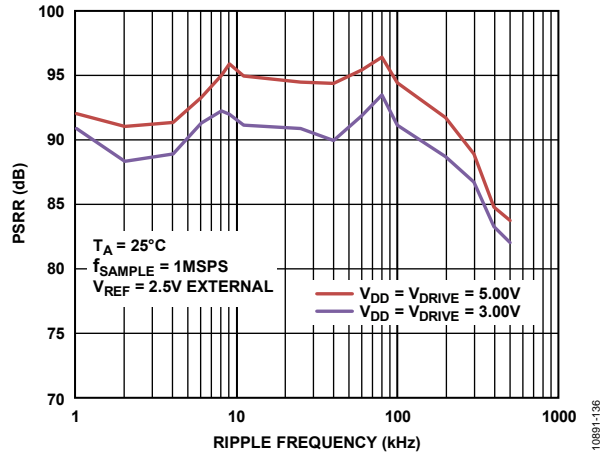

Figure 32. PSRR vs. Ripple Frequency

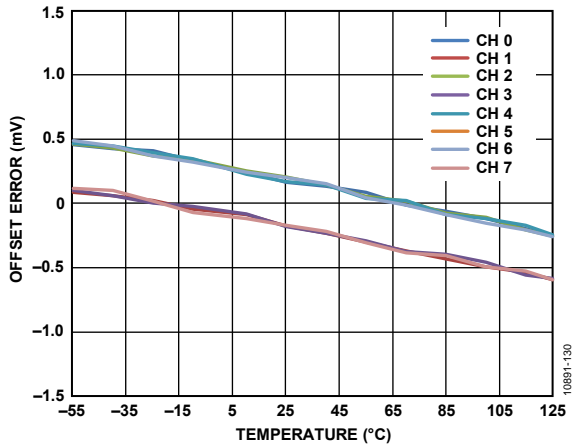

Figure 30. Offset Error vs. Temperature

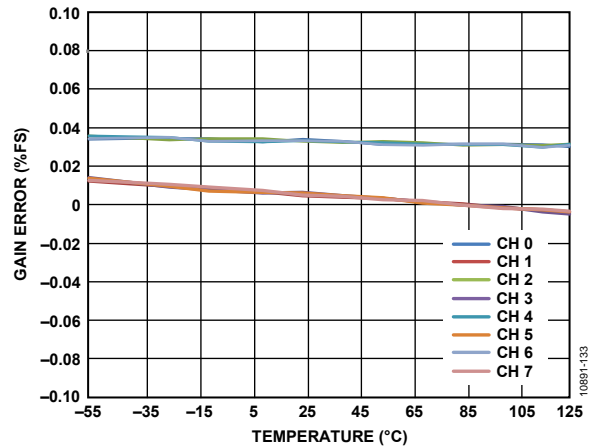

Figure 33. Gain Error vs. Temperature

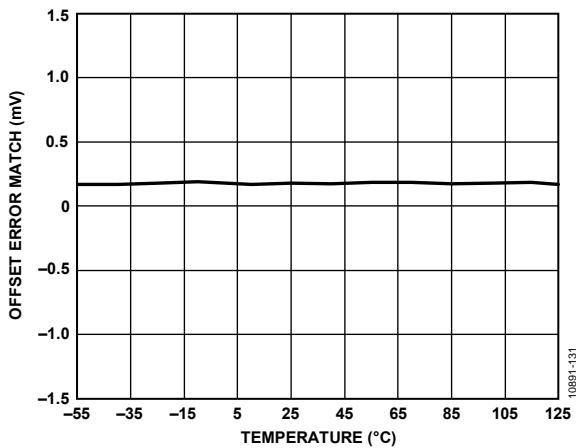

Figure 31. Offset Error Match vs. Temperature

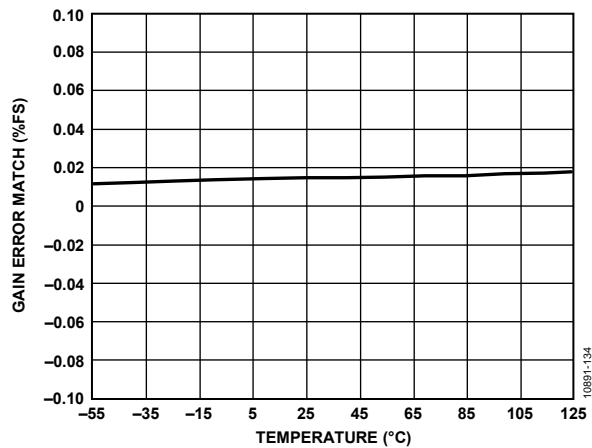

Figure 34. Gain Error Match vs. Temperature

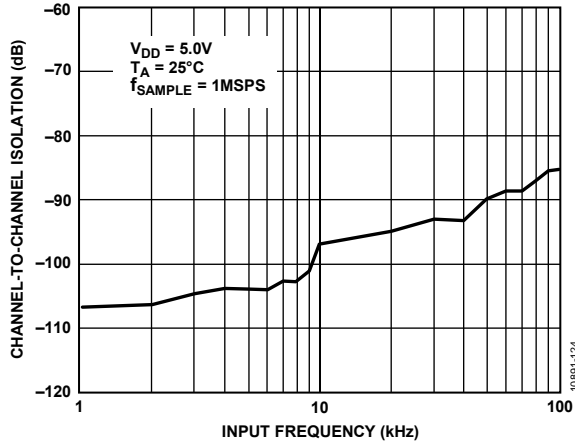

Figure 35. Channel-to-Channel Isolation vs. Input Frequency

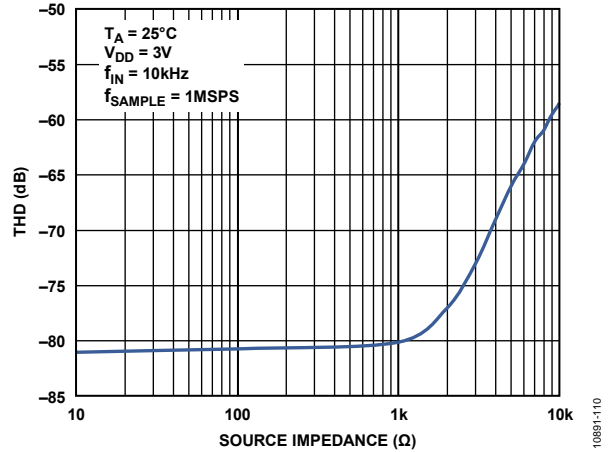

Figure 38. THD vs. Source Impedance

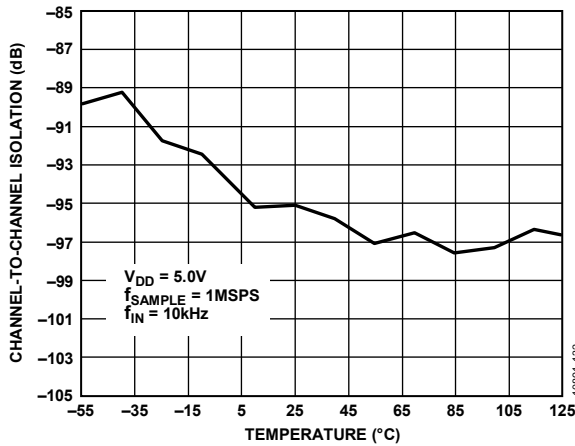

Figure 36. Channel-to-Channel Isolation vs. Temperature

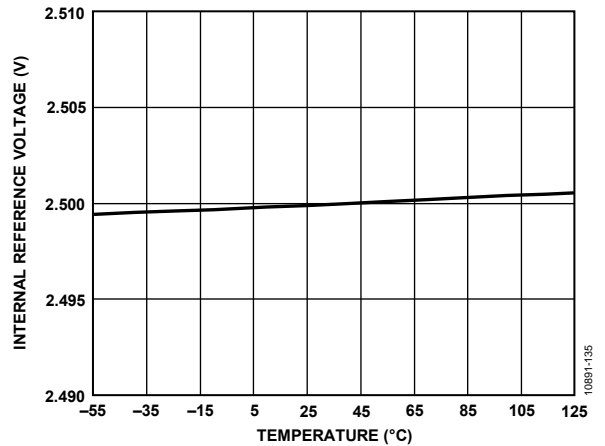

Figure 39. Internal Reference Voltage vs. Temperature

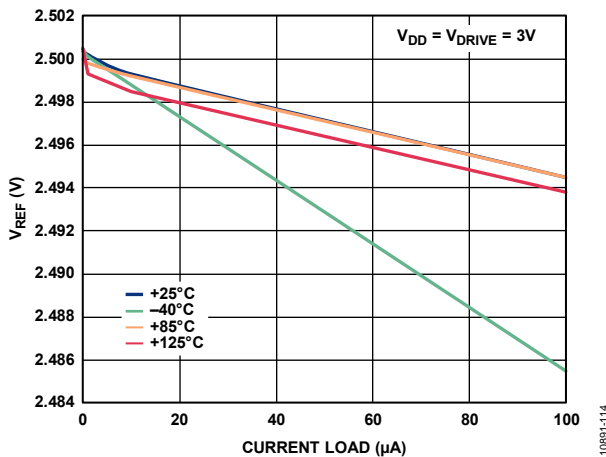

Figure 37. Reference Voltage Output ( $V_{REF}$ ) vs. Current Load for Various Temperatures



## TERMINOLOGY

### Integral Nonlinearity (INL)

INL is the maximum deviation from a straight line passing through the endpoints of the ADC transfer function. For the [AD7091R-2/AD7091R-4/AD7091R-8](#), the endpoints of the transfer function are zero scale, a point ½ LSB below the first code transition, and full scale, a point ½ LSB above the last code transition.

### Differential Nonlinearity (DNL)

DNL is the difference between the measured and the ideal 1 LSB change between any two adjacent codes in the ADC.

### Offset Error

The offset error is the deviation of the first code transition (00 ... 000 to 00 ... 001) from the ideal (such as GND + 0.5 LSB).

### Offset Error Match

Offset error match is the difference in offset error between any two input channels.

### Gain Error

For the [AD7091R-2/AD7091R-4/AD7091R-8](#), the gain error is the deviation of the last code transition (111 ... 110 to 111 ... 111) from the ideal (such as  $V_{REF} - 1.5$  LSB) after the offset error has been adjusted out.

### Gain Error Match

Gain error match is the difference in gain error between any two input channels.

### Transient Response Time

The track-and-hold amplifier returns to track mode after the end of conversion. The track-and-hold acquisition time is the time required for the output of the track-and-hold amplifier to reach its final value, within  $\pm 0.5$  LSB, after the end of conversion. See the Serial Port Interface section for more details.

### Signal-to-Noise-and-Distortion (SINAD) Ratio

SINAD is the measured ratio of signal-to-noise-and-distortion at the output of the ADC. The signal is the rms amplitude of the fundamental. Noise is the sum of all nonfundamental signals up to half the sampling frequency ( $f_s/2$ ), excluding dc.

The ratio is dependent on the number of quantization levels in the digitization process; the more levels, the smaller the quantization noise. The theoretical SINAD ratio for an ideal N-bit converter with a sine wave input is given by

$$SINAD = (6.02N + 1.76) \text{ dB}$$

Thus, for a 12-bit converter, the SINAD ratio is 74 dB.

### Channel-to-Channel Isolation

Channel-to-channel isolation is a measure of the level of crosstalk between the selected channel and all of the other channels. It is measured by applying a full-scale, 10 kHz sine wave signal to all unselected input channels and determining the degree to which the signal attenuates in the selected channel that has a dc signal applied to it. Figure 35 shows the worst case across all channels for the [AD7091R-2/AD7091R-4/AD7091R-8](#).

### Total Harmonic Distortion (THD)

THD is the ratio of the rms sum of harmonics to the fundamental. For the [AD7091R-2/AD7091R-4/AD7091R-8](#), it is defined as

$$THD(\text{dB}) = 20 \log \frac{\sqrt{V_2^2 + V_3^2 + V_4^2 + V_5^2 + V_6^2}}{V_1}$$

where:

$V_1$  is the rms amplitude of the fundamental.

$V_2$ ,  $V_3$ ,  $V_4$ ,  $V_5$ , and  $V_6$  are the rms amplitudes of the second through the sixth harmonic.

### Spurious-Free Dynamic Range (SFDR)

SFDR is the difference, in decibels, between the rms amplitude of the input signal and the peak spurious signal.

## THEORY OF OPERATION

### CIRCUIT INFORMATION

The AD7091R-2/AD7091R-4/AD7091R-8 are 12-bit, fast (1 MSPS), ultralow power, single-supply ADCs. The devices operate from a 2.7 V to 5.25 V supply. The AD7091R-2/AD7091R-4/AD7091R-8 are capable of throughput rates of 1 MSPS.

The AD7091R-2/AD7091R-4/AD7091R-8 provide an on-chip, track-and-hold ADC and a serial interface housed in a 16-lead, 20-lead, or 24-lead TSSOP or LFCSP package, which offers considerable space-saving advantages over alternative solutions. The serial clock input accesses data from the device. The clock for the successive approximation ADC is generated internally. The reference voltage for the AD7091R-2/AD7091R-4/AD7091R-8 is provided externally, or it is generated internally by an accurate on-chip reference source. The analog input range for the AD7091R-2/AD7091R-4/AD7091R-8 is 0 V to  $V_{REF}$ .

The AD7091R-2/AD7091R-4/AD7091R-8 also feature a power-down option to save power between conversions. The power-down feature is implemented across the standard serial interface as described in the Modes of Operation section.

### CONVERTER OPERATION

The AD7091R-2/AD7091R-4/AD7091R-8 are successive approximation ADCs based on a charge redistribution digital-to-analog converter (DAC). Figure 40 and Figure 41 show simplified schematics of the ADC. Figure 40 shows the ADC during its acquisition phase. When SW2 is closed and SW1 is in Position A, the comparator is held in a balanced condition, and the sampling capacitor acquires the signal on  $V_{IN}$ .

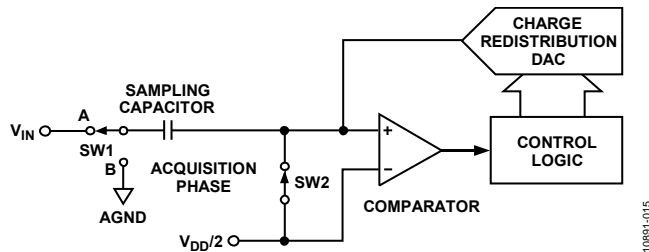

Figure 40. ADC Acquisition Phase

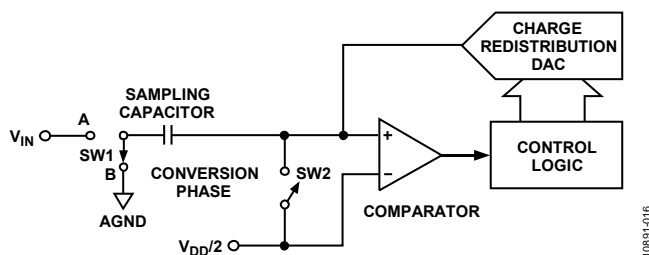

Figure 41. ADC Conversion Phase

When the ADC starts a conversion, SW2 opens and SW1 moves to Position B, causing the comparator to become unbalanced (see Figure 41). Using the control logic, the charge redistribution DAC adds and subtracts fixed amounts of charge from the sampling capacitor to bring the comparator back into a balanced condition. When the SAR decisions are made, the comparator inputs are rebalanced. From these SAR decisions, the control logic generates the ADC output code.

### ADC TRANSFER FUNCTION

The output coding of the AD7091R-2/AD7091R-4/AD7091R-8 is straight binary. The designed code transitions occur midway between successive integer LSB values, such as  $\frac{1}{2}$  LSB,  $1\frac{1}{2}$  LSB, and so on. The LSB size for the AD7091R-2/AD7091R-4/AD7091R-8 is  $V_{REF}/4096$ . The ideal transfer characteristic for the AD7091R-2/AD7091R-4/AD7091R-8 is shown in Figure 42.

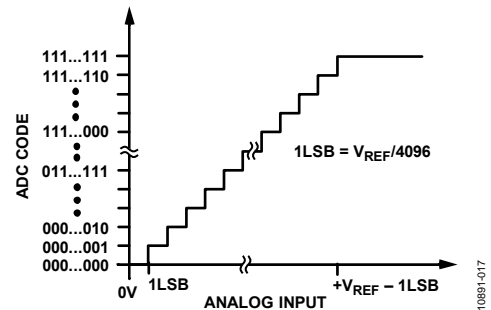

Figure 42. AD7091R-2/AD7091R-4/AD7091R-8 Transfer Characteristic

### REFERENCE

The AD7091R-2/AD7091R-4/AD7091R-8 can operate with either the internal 2.5 V on-chip reference or an externally applied reference. The logic state of the P\_DOWN LSB bit in the configuration register determines whether the internal reference is used. The internal reference is selected for the ADCs when the P\_DOWN LSB bit is set to 1.

When the P\_DOWN LSB bit is set to 0, supply an external reference in the range of 1.0 V to  $V_{DD}$  through the  $REF_{IN}/REF_{OUT}$  pin. At power-up, the internal reference disables by default.

The internal reference circuitry consists of a 2.5 V band gap reference and a reference buffer. When operating the AD7091R-2/AD7091R-4/AD7091R-8 in internal reference mode, the 2.5 V internal reference is available at the  $REF_{IN}/REF_{OUT}$  pin, which is typically decoupled to GND using a 2.2  $\mu$ F capacitor. It is recommended to buffer the internal reference before applying it elsewhere in the system.

The reference buffer requires 50 ms to power up and charge the 2.2  $\mu$ F decoupling capacitor during the power-up time.

## POWER SUPPLY

The AD7091R-2/AD7091R-4/AD7091R-8 use two power supply pins: a core supply ( $V_{DD}$ ) and a digital input/output interface supply ( $V_{DRIVE}$ ).  $V_{DRIVE}$  allows direct interface with any logic between 1.8 V and 5.25 V. To reduce the number of supplies needed,  $V_{DRIVE}$  and  $V_{DD}$  can be tied together depending upon the logic levels of the system. Additionally, the AD7091R-2/AD7091R-4/AD7091R-8 are insensitive to power supply variation over a wide frequency range, as shown in Figure 32. AD7091R-2/AD7091R-4/AD7091R-8 operation is independent of power supply sequencing between  $V_{DRIVE}$  and  $V_{DD}$ .

The AD7091R-2/AD7091R-4/AD7091R-8 power down automatically at the end of each conversion phase; therefore, the power scales linearly with the sampling rate. The automatic power-down feature makes the AD7091R-2/AD7091R-4/AD7091R-8 devices ideal for low sampling rates (of even a few hertz) and battery-powered applications.

**Table 8. Recommended Power Management Devices<sup>1</sup>**

Product	Description
ADP7102	20 V, 300 mA, low noise, CMOS LDO
ADM7160	Ultralow noise, 200 mA linear regulator
ADP162	Ultralow quiescent current, CMOS linear regulator

<sup>1</sup> For the latest recommended power management devices, see the AD7091R-2/AD7091R-4/AD7091R-8 product pages.

## DEVICE RESET

Upon power up, a reset pulse of at least 10 ns in width must be provided on the RESET pin to ensure proper initialization of the device. Failure to apply the reset pulse may result in a device malfunction. See Figure 43 for reset pulse timing relative to power supply establishment. If the system has a limited number of digital pins and one cannot be allocated to the reset pin of the ADC, a software reset may be issued in place of the hardware reset signal (see the Power-On Device Initialization section).

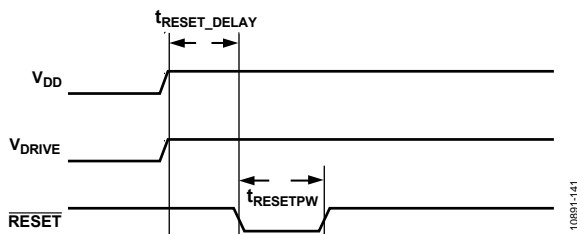

Figure 43. RESET Pin Power Up Timing

## TYPICAL CONNECTION DIAGRAM

Figure 45 shows a typical connection diagram for the AD7091R-2/AD7091R-4/AD7091R-8.

Connect a positive power supply in the 2.7 V to 5.25 V range to the  $V_{DD}$  pin. Typical values for these decoupling capacitors are 0.1  $\mu\text{F}$  and 10  $\mu\text{F}$ . Place these capacitors near the device pins. Take care to decouple the  $\text{REF}_{\text{IN}}/\text{REF}_{\text{OUT}}$  pin to achieve specified performance. The typical value for the  $\text{REF}_{\text{IN}}/\text{REF}_{\text{OUT}}$  capacitor is 2.2  $\mu\text{F}$ , which provides an analog input range of 0 V to  $V_{\text{REF}}$ .

The typical value for the regulator bypass (REGCAP) decoupling capacitor is 1.0  $\mu\text{F}$ . The voltage applied to the  $V_{\text{DRIVE}}$  input controls the voltage of the serial interface; therefore, connect this pin to the supply voltage of the microprocessor. Set  $V_{\text{DRIVE}}$  in the 1.8 V to 5.25 V range. Typical values for the  $V_{\text{DRIVE}}$  decoupling capacitors are 0.1  $\mu\text{F}$  and 10  $\mu\text{F}$ . The conversion result is output in a 16-bit word with the MSBs first.

When an externally applied reference is required, disable the internal reference using the configuration register. Choose the externally applied reference voltage in the 1.0 V to 5.25 V  $V_{\text{DD}}$  range and connect it to the  $\text{REF}_{\text{IN}}/\text{REF}_{\text{OUT}}$  pin.

For applications where power consumption is a concern, use the power-down mode of the ADC to improve power performance. See the Modes of Operation section for additional details.

## ANALOG INPUT

Figure 44 shows an equivalent circuit of the analog input structure of the AD7091R-2/AD7091R-4/AD7091R-8. The two diodes, D1 and D2, provide ESD protection for the analog input. Take care to ensure that the analog input signal never exceeds the supply rails by more than 300 mV because this causes these diodes to become forward-biased and start conducting current into the substrate. These diodes can conduct a maximum of 10 mA without causing irreversible damage to the device.

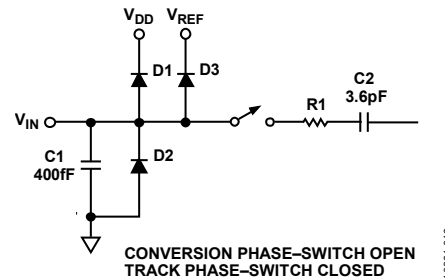

Figure 44. Equivalent Analog Input Circuit

The C1 capacitor in Figure 44 is typically about 400 fF and can primarily be attributed to pin capacitance. The R1 resistor is a lumped component composed of the on resistance of a switch. This resistor is typically about 500  $\Omega$ . The C2 capacitor is the ADC sampling capacitor and typically has a capacitance of 3.6 pF.

In applications where harmonic distortion and signal-to-noise ratio are critical, drive the analog inputs from low impedance sources. Large source impedances significantly affect the ac performance of the ADC that can necessitate using input buffer amplifiers, as shown in Figure 45. The choice of the op amp is a function of the particular application.

When no amplifiers are used to drive the analog input, limit the source impedance to low values. The maximum source impedance depends on the amount of THD that can be tolerated. The THD increases as the source impedance increases and performance degrades.

Use an external filter on the analog input signal paths to the [AD7091R-2/AD7091R-4/AD7091R-8](#)  $V_{INX}$  pins to achieve the specified performance. This filter can be a one-pole low-pass RC filter, or similar.

Connect the  $MUX_{OUT}$  pin directly to the  $ADC_{IN}$  pin. Insert a buffer amplifier in the path, if desired. When sequencing channels, do not place a filter between  $MUX_{OUT}$  and the input to any buffering because doing so leads to crosstalk. If buffering is not employed, do not place a filter between  $MUX_{OUT}$  and  $ADC_{IN}$  when sequencing channels because doing so leads to crosstalk.

### DRIVER AMPLIFIER CHOICE

Although the [AD7091R-2/AD7091R-4/AD7091R-8](#) are easy to drive, a driver amplifier must meet the following requirements:

- The noise generated by the driver amplifier must be kept as low as possible to preserve the SNR and transition noise performance of the [AD7091R-2/AD7091R-4/AD7091R-8](#). The noise from the driver is filtered by the one-pole, low-pass filter of the [AD7091R-2/AD7091R-4/AD7091R-8](#) analog input circuit, made by R1 and C2, or by the external filter, if one is used. Because the typical noise of the [AD7091R-2/AD7091R-4/AD7091R-8](#) is 280  $\mu\text{V}$  rms, the SNR degradation due to the amplifier is

$$SNR_{LOSS} = 20 \log \left( \frac{280}{\sqrt{280^2 + \frac{\pi}{2} f_{-3dB} (Ne_N)^2}} \right)$$

where:

$f_{-3dB}$  is the input bandwidth, in megahertz, of the [AD7091R-2/AD7091R-4/AD7091R-8](#) (1.5 MHz), or the cutoff frequency of the input filter, if one is used.

$N$  is the noise gain of the amplifier (for example, gain = 1 in buffer configuration; see Figure 45).

$e_N$  is the equivalent input noise voltage of the op amp, in  $\text{nV}/\sqrt{\text{Hz}}$ .

- For ac applications, the driver must have a THD performance that is commensurate with the [AD7091R-2/AD7091R-4/AD7091R-8](#).
- If the buffer is placed between  $MUX_{OUT}$  and  $ADC_{IN}$ , the driver amplifier and the [AD7091R-2/AD7091R-4/AD7091R-8](#) analog input circuit must settle for a full-scale step onto the capacitor array at a 12-bit level (0.0244%, 244 ppm). In an amplifier data sheet, settling at 0.1% to 0.01% is more commonly specified and may differ significantly from the settling time at a 12-bit level. Be sure to verify the amplifier settling time prior to driver selection.

**Table 9. Recommended Driver Amplifiers<sup>1</sup>**

Product	Description
<a href="#">ADA4805-1</a>	Low noise, ultralow power, wide bandwidth amplifier
<a href="#">AD8031</a>	Low voltage, low power, single channel amplifier
<a href="#">AD8032</a>	Low voltage, low power, dual channel amplifier
<a href="#">AD8615</a>	Low frequency, low voltage amplifier

<sup>1</sup> For the latest recommended ADC driver products, see the [AD7091R-2/AD7091R-4/AD7091R-8](#) product pages.

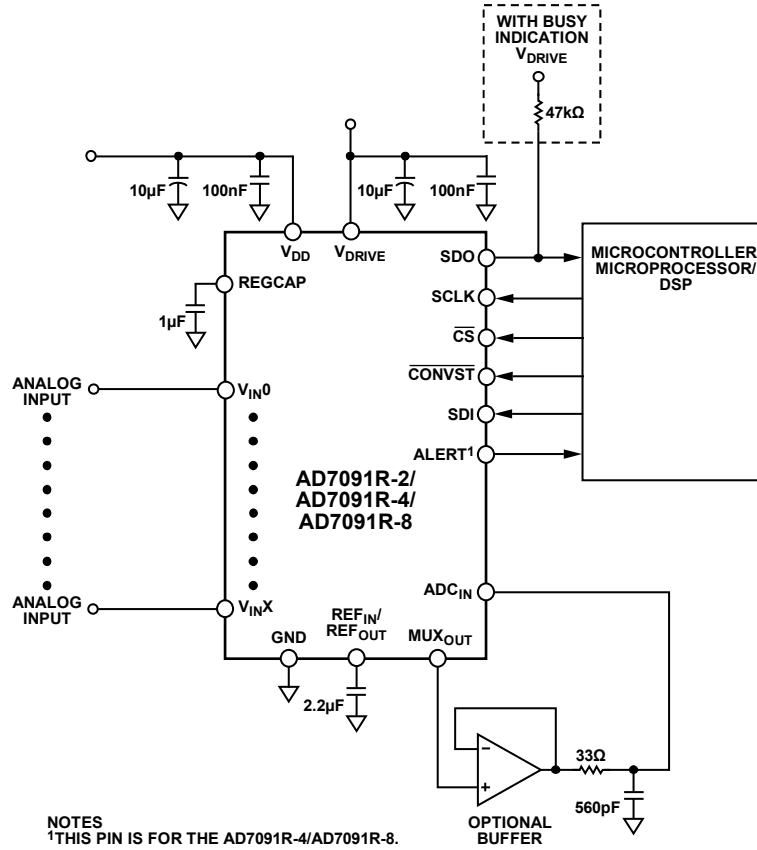

Figure 45. Typical Connection Diagram with Optional Buffer

10891-018

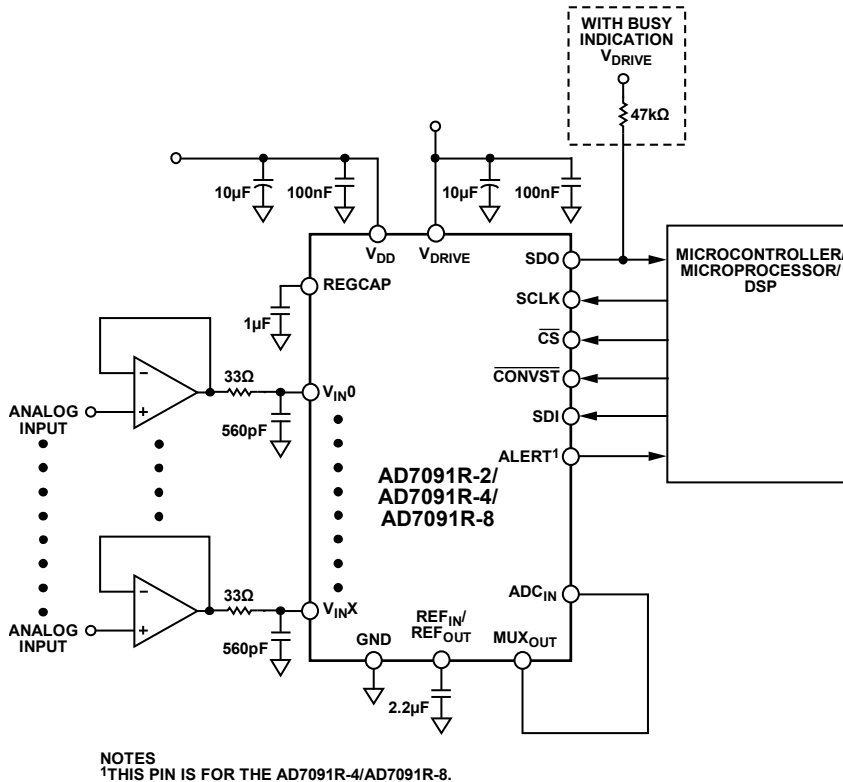

Figure 46. Typical Connection Diagram Without Optional Buffer

10891-140

## REGISTERS

The AD7091R-2/AD7091R-4/AD7091R-8 have user programmable registers. Table 10 contains the complete list of registers.

The registers are either read/write (R/W) or read only (R). Data is written to or read back from the read/write registers. Read only registers is only read. Any write to a read only register or unimplemented register address is considered no operation (NOP). A NOP command is an SPI command that is ignored by the AD7091R-2/AD7091R-4/AD7091R-8. After a write to a read only register, the output on the subsequent SPI frame is all zeros if there was no conversion before the next SPI frame. Similarly, any read of an unimplemented register outputs zeros.

## ADDRESSING REGISTERS

A serial transfer on the AD7091R-2/AD7091R-4/AD7091R-8 consists of 16 SCLK cycles. The six MSBs on the SDI line during the 16 SCLK transfer are decoded to determine which register is addressed. The six MSBs consist of the register address (ADDx), Bits[4:0], and the read/write bit. The register address bits determine which of the on-chip registers are selected. The read/write bit determines if the data on the SDI line following the read/write bit loads into the addressed register. If the read/write bit is 1, the bits load into the register addressed by the register select bits. Data loads into the register on the rising edge of CS. If the read/write bit is 0, the command is seen as a read request. The requested register data is available on the subsequent message on the SDO line.

**Table 10. Register Description**

Address	Register Name	Default	Access		
			AD7091R-8	AD7091R-4	AD7091R-2
0x00	Conversion result	0x0000	R	R	R
0x01	Channel	0x0000	R/W	R/W	R/W
0x02	Configuration	0x00C0	R/W	R/W	R/W
0x03	Alert indication	0x0000	R	R	R
0x04	Channel 0 low limit	0x0000	R/W	R/W	R/W
0x05	Channel 0 high limit	0x01FF	R/W	R/W	R/W
0x06	Channel 0 hysteresis	0x01FF	R/W	R/W	R/W
0x07	Channel 1 low limit	0x0000	R/W	R/W	R/W
0x08	Channel 1 high limit	0x01FF	R/W	R/W	R/W
0x09	Channel 1 hysteresis	0x01FF	R/W	R/W	R/W
0x0A	Channel 2 low limit	0x0000	R/W	R/W	NOP
0x0B	Channel 2 high limit	0x01FF	R/W	R/W	NOP
0x0C	Channel 2 hysteresis	0x01FF	R/W	R/W	NOP
0x0D	Channel 3 low limit	0x0000	R/W	R/W	NOP
0x0E	Channel 3 high limit	0x01FF	R/W	R/W	NOP
0x0F	Channel 3 hysteresis	0x01FF	R/W	R/W	NOP
0x10	Channel 4 low limit	0x0000	R/W	NOP	NOP
0x11	Channel 4 high limit	0x01FF	R/W	NOP	NOP
0x12	Channel 4 hysteresis	0x01FF	R/W	NOP	NOP
0x13	Channel 5 low limit	0x0000	R/W	NOP	NOP
0x14	Channel 5 high limit	0x01FF	R/W	NOP	NOP
0x15	Channel 5 hysteresis	0x01FF	R/W	NOP	NOP
0x16	Channel 6 low limit	0x0000	R/W	NOP	NOP
0x17	Channel 6 high limit	0x01FF	R/W	NOP	NOP
0x18	Channel 6 hysteresis	0x01FF	R/W	NOP	NOP
0x19	Channel 7 low limit	0x0000	R/W	NOP	NOP
0x1A	Channel 7 high limit	0x01FF	R/W	NOP	NOP
0x1B	Channel 7 hysteresis	0x01FF	R/W	NOP	NOP
0x1C	Reserved	0x0000	NOP	NOP	NOP
...	...	...	...	...	...
0x1F	Reserved	0x0000	NOP	NOP	NOP

**CONVERSION RESULT REGISTER**

The conversion result register is a 16-bit, read only register that stores the results from the most recent ADC conversion in straight binary format. The channel ID of the converted channel and the alert status are also included in the register.

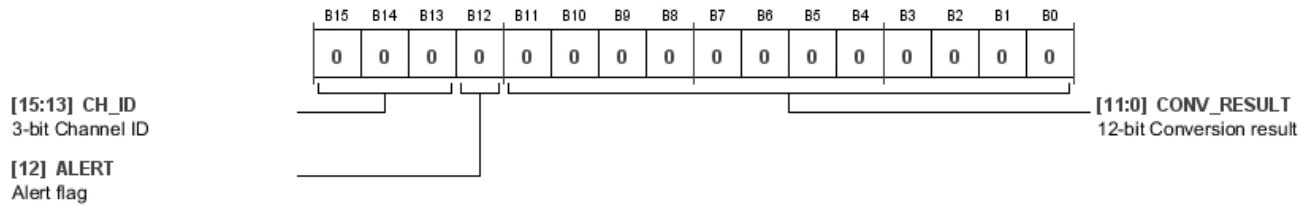

Figure 47. Conversion Result Register

Table 11. Conversion Result Register Map

MSB															LSB
B15	B14	B13	B12	B11	B10	B9	B8	B7	B6	B5	B4	B3	B2	B1	B0
CH_ID			ALERT	CONV_RESULT											

Table 12. Bit Descriptions for the Conversion Result Register

Bit(s)	Name	Description	Reset	Access			
[15:13]	CH_ID	3-bit channel ID of channel converted	0x0	R			
		<b>B15</b> <sup>1,2</sup>			<b>B14</b> <sup>2</sup>	<b>B13</b>	<b>Analog Input Channel</b>
		0			0	0	V <sub>IN0</sub>
		0			0	1	V <sub>IN1</sub>
		0			1	0	V <sub>IN2</sub>
		0			1	1	V <sub>IN3</sub>
		1			0	0	V <sub>IN4</sub>
		1			0	1	V <sub>IN5</sub>
1	1	0	V <sub>IN6</sub>				
1	1	1	V <sub>IN7</sub>				
12	ALERT	ALERT flag 0: No ALERT occurred 1: ALERT occurred	0	R			
[11:0]	CONV_RESULT	12-bit conversion result	0x000	R			

<sup>1</sup> Always zero on the AD7091R-4.<sup>2</sup> Always zero on the AD7091R-2.

**CHANNEL REGISTER**

The channel register on the AD7091R-2/AD7091R-4/AD7091R-8 is an 8-bit, read/write register. Each of the eight analog input channels has one corresponding bit in the channel register. To select a channel for inclusion in the channel conversion sequence, set the corresponding channel bit to 1 in the channel register. There is a latency of one conversion before the channel conversion sequence is updated. If the channel register is programmed with a new value, the conversion sequence is reset to the lowest numbered channel in the new value.

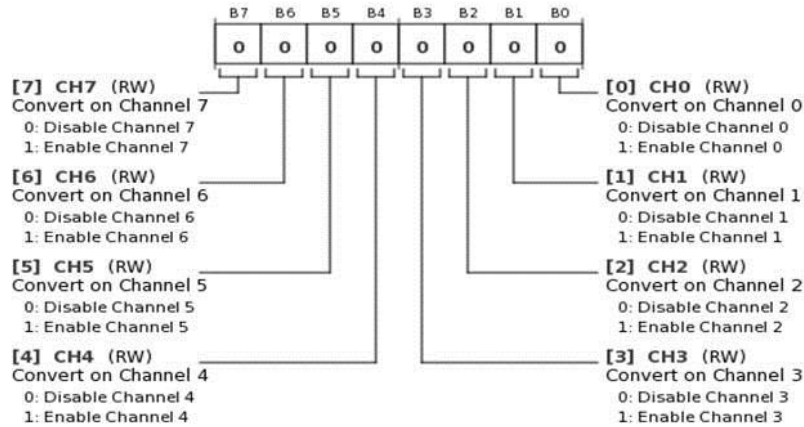

Figure 48. Channel Registers

Table 13. Channel Register Map

MSB														LSB	
B15	B14	B13	B12	B11	B10	B9	B8	B7	B6	B5	B4	B3	B2	B1	B0
Reserved								CH7	CH6	CH5	CH4	CH3	CH2	CH1	CH0

Table 14. Bit Descriptions for the Channel Register

Bit(s)	Name	Description	Reset	Access
[15:8]	Reserved	Reserved	0x00	R
7	CH7	Convert on Channel 7 0: Disable Channel 7 1: Enable Channel 7	0x0	R/W
6	CH6	Convert on Channel 6 0: Disable Channel 6 1: Enable Channel 6	0x0	R/W
5	CH5	Convert on Channel 5 0: Disable Channel 5 1: Enable Channel 5	0x0	R/W
4	CH4	Convert on Channel 4 0: Disable Channel 4 1: Enable Channel 4	0x0	R/W
3	CH3	Convert on Channel 3 0: Disable Channel 3 1: Enable Channel 3	0x0	R/W
2	CH2	Convert on Channel 2 0: Disable Channel 2 1: Enable Channel 2	0x0	R/W
1	CH1	Convert on Channel 1 0: Disable Channel 1 1: Enable Channel 1	0x0	R/W
0	CH0	Convert on Channel 0 0: Disable Channel 0 1: Enable Channel 0	0x0	R/W



## CONFIGURATION REGISTER

The configuration register is a 16-bit, read/write register that is used to set the operating modes of the [AD7091R-2/AD7091R-4/AD7091R-8](#).

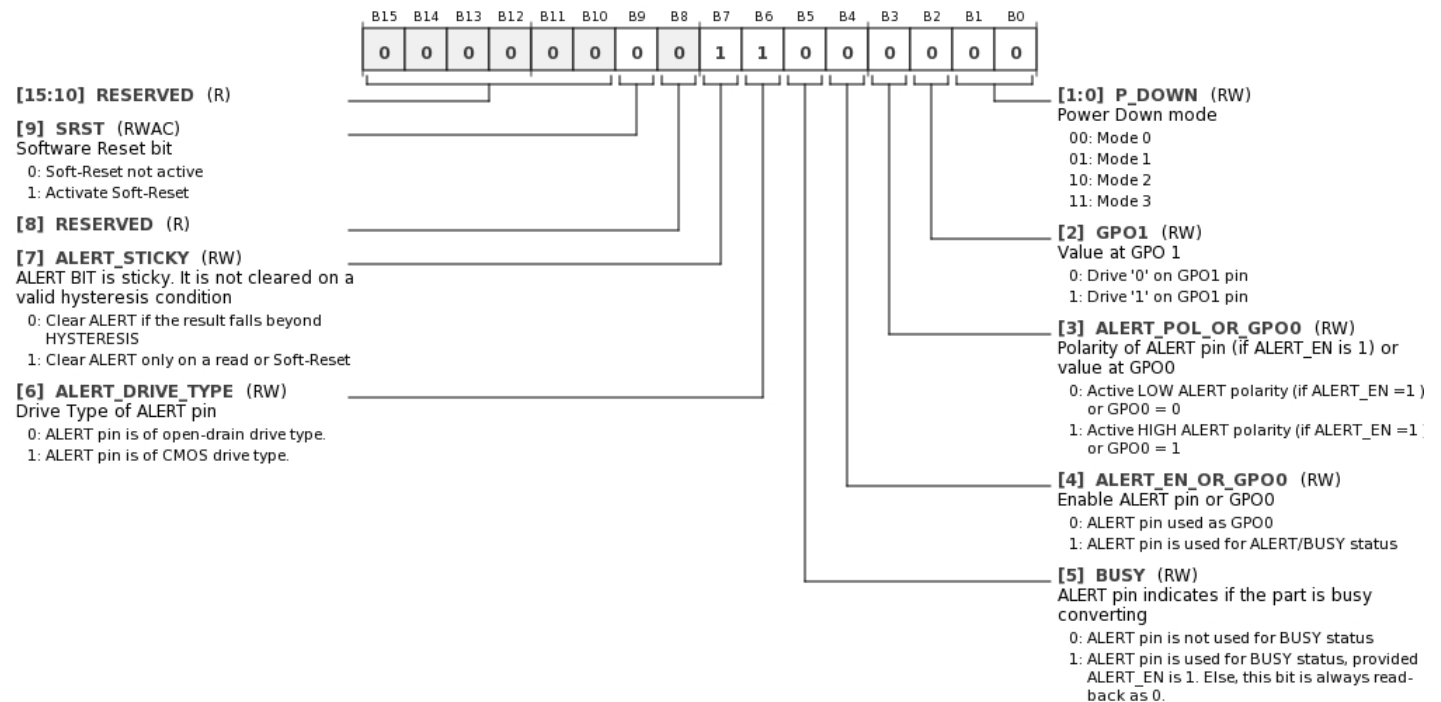

Figure 49. Configuration Register

Table 15. Configuration Register Map

MSB														LSB	
B15	B14	B13	B12	B11	B10	B9	B8	B7	B6	B5	B4	B3	B2	B1	B0
Reserved						SRST	Reserved	ALERT_STICKY	ALERT_DRIVE_TYPE	BUSY	ALERT_EN_OR_GPO0	ALERT_POL_OR_GPO0	GPO1	P_DOWN	

Table 16. Bit Descriptions for the Configuration Register

Bit(s)	Name	Description	Reset	Access
[15:10]	Reserved	Reserved	0x00	R
9	SRST	Software reset bit. Setting this bit resets the internal digital control logic and the result and alert registers, but it does not reset the other memory map registers. This bit automatically clears in the next clock cycle. Note that it loads random access memory (RAM) from fuses. 0: Soft reset not active. 1: Activate soft reset.	0x0	RWAC
8	Reserved	Reserved	0x0	R
7	ALERT_STICKY	ALERT bit is sticky. It is not cleared on a valid hysteresis condition. 0: Clear ALERT <sup>1</sup> if the result falls beyond hysteresis. 1: Clear ALERT <sup>1</sup> only on a read or soft reset.	0x1	R/W
6	ALERT_DRIVE_TYPE	Drive type of ALERT <sup>1</sup> pin. 0: ALERT <sup>1</sup> pin is of open-drain drive type. 1: ALERT <sup>1</sup> pin is of CMOS drive type.	0x1	R/W
5	BUSY	ALERT <sup>1</sup> pin indicates if the part is busy converting. 0: ALERT <sup>1</sup> pin is not used for BUSY status. 1: ALERT <sup>1</sup> pin is used for BUSY status, provided ALERT_EN_OR_GPO0 is 1. Else, this bit is always read back as 0.	0x0	R/W

Bit(s)	Name	Description	Reset	Access																				
4	ALERT_EN_OR_GPO0	Enable ALERT pin or GPO <sub>0</sub> <sup>1</sup> . 0: ALERT <sup>1</sup> pin used as GPO <sub>0</sub> <sup>1</sup> . 1: ALERT <sup>1</sup> pin is used for ALERT <sup>1</sup> /BUSY <sup>1</sup> status.	0x0	R/W																				
3	ALERT_POL_OR_GPO0	Polarity of ALERT <sup>1</sup> pin (if ALERT_EN_OR_GPO0 is 1) or value at GPO <sub>0</sub> <sup>1</sup> . 0: Active low ALERT <sup>1</sup> polarity (if ALERT_EN_OR_GPO0 = 1) or GPO <sub>0</sub> <sup>1</sup> = 0. 1: Active high ALERT <sup>1</sup> polarity (if ALERT_EN_OR_GPO0 = 1) or GPO <sub>0</sub> <sup>1</sup> = 1.	0x0	R/W																				
2	GPO1	Value at GPO <sub>1</sub> <sup>1</sup> . 0: Drive 0 on GPO <sub>1</sub> <sup>1</sup> pin. 1: Drive 1 on GPO <sub>1</sub> <sup>1</sup> pin.	0x0	R/W																				
[1:0]	P_DOWN	Power-down mode.	0x0	R/W																				
		<table border="1"> <thead> <tr> <th>Setting</th> <th>Mode</th> <th>Sleep Mode/Bias Generator</th> <th>Internal Reference</th> </tr> </thead> <tbody> <tr> <td>00</td> <td>Mode 0</td> <td>Off</td> <td>Off</td> </tr> <tr> <td>01</td> <td>Mode 1</td> <td>Off</td> <td>On</td> </tr> <tr> <td>10</td> <td>Mode 2</td> <td>On</td> <td>Off</td> </tr> <tr> <td>11</td> <td>Mode 3</td> <td>On</td> <td>On</td> </tr> </tbody> </table>			Setting	Mode	Sleep Mode/Bias Generator	Internal Reference	00	Mode 0	Off	Off	01	Mode 1	Off	On	10	Mode 2	On	Off	11	Mode 3	On	On
Setting	Mode	Sleep Mode/Bias Generator			Internal Reference																			
00	Mode 0	Off			Off																			
01	Mode 1	Off			On																			
10	Mode 2	On	Off																					
11	Mode 3	On	On																					

<sup>1</sup> When referring to a single function of a multifunction pin in the parameters, only the portion of the pin name that is relevant to the specification is listed. For full pin names of multifunction pins, refer to the Pin Configurations and Function Descriptions section.

**ALERT INDICATION REGISTER**

The 16-bit, alert indication register is a read only register that provides information on an alert event. If a conversion result activates the ALERT function of the ALERT/BUSY/GPO<sub>0</sub> pin, as described in the Channel x Low Limit Register section and the Channel x High Limit Register section, the alert register can be read to determine the source of the alert. The register contains two status bits per channel, one corresponding to the high limit, and the other to the low limit. The bit with a status equal to 1 shows where the violation occurred, that is, on which channel, and whether the violation occurred on the upper or lower limit.

If a second alert event occurs on another channel between receiving the first alert and interrogating the alert register, the corresponding bit for that alert event is also set.

The contents of the alert indication register are reset by reading it. The alert indication register is reset on the second SCLK cycle of the SPI frame where the ALERT data is read out. If a conversion happens in the meantime, the conversion result is sent instead of the alert indication register contents. The alert indication register is not reset in this case.

The alert bits for any unimplemented channels on the 2-channel and 4-channel devices always return zeros.

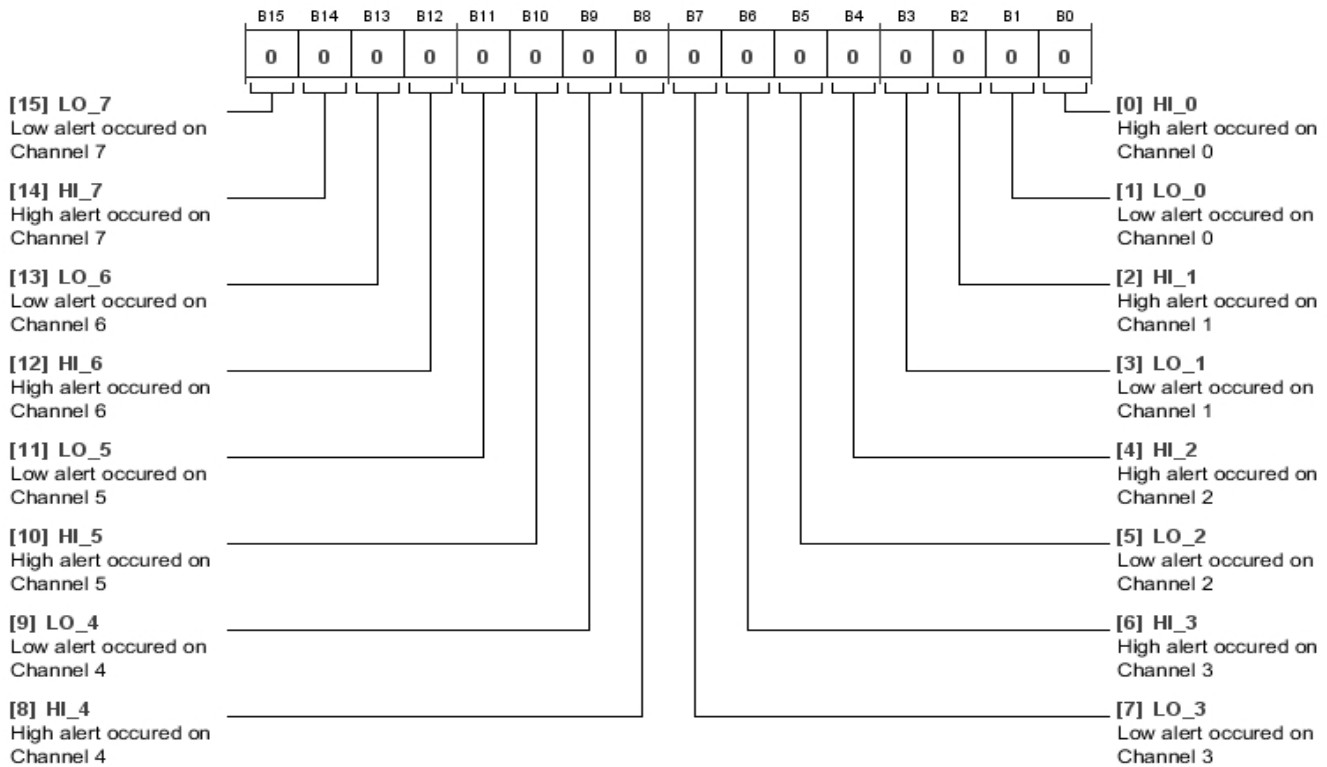

Figure 50. Alert Indication Register (Figure Shows Default Register Value of 0, Indicating No Alert Has Occurred)

Table 17. Alert Indication Register Map

MSB															LSB
B15	B14	B13	B12	B11	B10	B9	B8	B7	B6	B5	B4	B3	B2	B1	B0
LO_7	HI_7	LO_6	HI_6	LO_5	HI_5	LO_4	HI_4	LO_3	HI_3	LO_2	HI_2	LO_1	HI_1	LO_0	HI_0

Table 18. Bit Descriptions for the Alert Indication Register

Bit(s)	Bit Name	Description	Reset	Access
15	LO_7	Channel 7 low alert status 0: No alert on Channel 7 1: Low alert occurred on Channel 7	0x0	R
14	HI_7	Channel 7 high alert status 0: No alert on Channel 7 1: High alert occurred on Channel 7	0x0	R

Bit(s)	Bit Name	Description	Reset	Access
13	LO_6	Channel 6 low alert status 0: No alert on Channel 6 1: Low alert occurred on Channel 6	0x0	R
12	HI_6	Channel 6 high alert status 0: No alert on Channel 6 1: High alert occurred on Channel 6	0x0	R
11	LO_5	Channel 5 low alert status 0: No alert on Channel 5 1: Low alert occurred on Channel 5	0x0	R
10	HI_5	Channel 5 high alert status 0: No alert on Channel 5 1: High alert occurred on Channel 5	0x0	R
9	LO_4	Channel 4 low alert status 0: No alert on Channel 4 1: Low alert occurred on Channel 4	0x0	R
8	HI_4	Channel 4 high alert status 0: No alert on Channel 4 1: High alert occurred on Channel 4	0x0	R
7	LO_3	Channel 3 low alert status 0: No alert on Channel 3 1: Low alert occurred on Channel 3	0x0	R
6	HI_3	Channel 3 high alert status 0: No alert on Channel 3 1: High alert occurred on Channel 3	0x0	R
5	LO_2	Channel 2 low alert status 0: No alert on Channel 2 1: Low alert occurred on Channel 2	0x0	R
4	HI_2	Channel 2 high alert status 0: No alert on Channel 2 1: High alert occurred on Channel 2	0x0	R
3	LO_1	Channel 1 low alert status 0: No alert on Channel 1 1: Low alert occurred on Channel 1	0x0	R
2	HI_1	Channel 1 high alert status 0: No alert on Channel 1 1: High alert occurred on Channel 1	0x0	R
1	LO_0	Channel 0 low alert status 0: No alert on Channel 0 1: Low alert occurred on Channel 0	0x0	R
0	HI_0	Channel 0 high alert status 0: No alert on Channel 0 1: High alert occurred on Channel 0	0x0	R

**CHANNEL x LOW LIMIT REGISTER**

Each analog input channel of the AD7091R-2/AD7091R-4/AD7091R-8 has its own low limit register. The low limit registers are 16-bit read/write registers. See Table 10 for the register addresses. The low limit registers store the lower limit of the conversion value that activates the ALERT output.

Of the 16 bits, B15 to B9 are not used. Only the nine LSBs, B8 to B0, are used. These 9 bits, which are programmed by the user, are used as the MSBs of the internal 12-bit register. The 3 LSBs in the internal 12-bit registers are set to 000.

**CHANNEL x HIGH LIMIT REGISTER**

Each analog input channel of the AD7091R-2/AD7091R-4/AD7091R-8 has its own high limit register. The high limit registers are 16-bit read/write registers. See Table 10 for the register addresses. The high limit registers store the upper limit of the conversion value that activates the ALERT output.

Of the 16 bits, B15 to B9 are not used. Only the nine LSBs, B8 to B0, are used. These 9 bits, which are programmed by the user, are used as the MSBs of the internal 12-bit register. The 3 LSBs in the internal 12-bit registers are set to 111.

**CHANNEL x HYSTERESIS REGISTER**

Each analog input channel of the AD7091R-2/AD7091R-4/AD7091R-8 has its own hysteresis register, which are 16-bit read/write registers. See Table 10 for the register addresses. The hysteresis register stores the hysteresis value (N) when using the limit registers. The hysteresis value determines the reset point for the ALERT/BUSY/GPO<sub>0</sub> pin if a violation of the limits has occurred.

Of the 16 bits, B15 to B9 are not used. Only the nine LSBs, B8 to B0, are used. These 9 bits, which are programmed by the user, are used as the MSBs of the internal 12-bit register. The 3 LSBs in the internal 12-bit registers are set to 000.

Table 19. Channel x Low Limit Register Map

MSB														LSB	
B15	B14	B13	B12	B11	B10	B9	B8	B7	B6	B5	B4	B3	B2	B1	B0
Reserved							CHx LOW LIMIT								

Table 20. Bit Descriptions for the Channel x Low Limit Register

Bit(s)	Bit Name	Description	Reset	Access
[15:9]	Reserved	Reserved	0x00	R
[8:0]	CHx LOW LIMIT	Low limit value for Channel x	0x000	R/W

Table 21. Channel x High Limit Register Map

MSB														LSB	
B15	B14	B13	B12	B11	B10	B9	B8	B7	B6	B5	B4	B3	B2	B1	B0
Reserved							CHx HIGH LIMIT								

Table 22. Bit Descriptions for the Channel x High Limit Register

Bits	Bit Name	Description	Reset	Access
[15:9]	Reserved	Reserved	0x00	R
[8:0]	CHx HIGH LIMIT	High limit value for Channel x	0x1FF	R/W

Table 23. Channel x Hysteresis Register Map

MSB														LSB	
B15	B14	B13	B12	B11	B10	B9	B8	B7	B6	B5	B4	B3	B2	B1	B0
Reserved							CHx HYSTERESIS								

Table 24. Bit Descriptions for the Channel x Hysteresis Register

Bit(s)	Bit Name	Description	Reset	Access
[15:9]	Reserved	Reserved	0x00	R
[8:0]	CHx HYSTERESIS	Hysteresis value for Channel x	0x1FF	R/W

## SERIAL PORT INTERFACE

The SPI is a 4-wire interface (three inputs and one output) for serial data communication. It has a chip select ( $\overline{CS}$ ) line, a serial clock (SCLK), a serial data input (SDI), and a serial data output (SDO). Data transfers on SDI and SDO take place with respect to SCLK.  $\overline{CS}$  is used to frame the data and is active low. When  $\overline{CS}$  is high, SDO is kept in high impedance. The falling edge of  $\overline{CS}$  takes the SDO line out of the high impedance state. A rising edge on  $\overline{CS}$  returns the SDO to a high impedance state.

The SPI implemented on the AD7091R-2/AD7091R-4/AD7091R-8 can support both of the following: CPHA and CPOL = 0, and CPHA and CPOL = 1. This support ensures that the device can interface to microcontrollers and DSPs that keep either SCLK high or SCLK low when  $\overline{CS}$  is not asserted. The device ignores SCLK toggling when  $\overline{CS}$  is not asserted.

### READING CONVERSION RESULT

The  $\overline{CONVST}$  signal is used to initiate the conversion process. A high-to-low transition on the  $\overline{CONVST}$  signal puts the track-and-hold into hold mode and samples the analog input at this point. A conversion is initiated and requires 600 ns to complete. Before the end of the conversion, take the  $\overline{CONVST}$  signal high again. When the conversion process is finished, the track-and-hold mode goes back into track mode. Then, take the  $\overline{CS}$  pin low, and the conversion result clocks out on the SDO pin. The data is shifted out of the device as a 16-bit word under the control of the serial clock (SCLK) input. The data is shifted out on the falling edge of SCLK, and the data bits are valid on both the rising edge and the falling edge. The MSB is shifted out on the falling edge of  $\overline{CS}$ . The final bit in the data transfer is valid

on the 16th rising edge and the 16th falling edge, having clocked out on the previous (15th) falling edge. After the 16th falling edge, take  $\overline{CS}$  high again to return the SDO to a high impedance state. If another conversion is required, take the  $\overline{CONVST}$  pin low again (after at least 1  $\mu$ s), and repeat the read cycle. The timing diagram for this operation is shown in Figure 52.

### WRITING DATA TO THE REGISTERS

All the read/write registers in the device can be written over the SPI. A register write command is performed by a single 16-bit SPI access. The format for a write command is shown in Table 25. Bits[B15:B11] contain the register address. See Table 10 for the complete list of register addresses. Setting Bit B10 to 1 selects a write command. The subsequent 10 bits (Bits[B9:B0]) contain the data to be written to the selected register.

### READING DATA FROM THE REGISTERS

All the registers in the device can be read over the SPI. A register read is performed by issuing a register read command followed by an additional SPI command that can be either a valid command or NOP. The format for a read command is shown in Table 26. Bits[B15:B11] contain the register address. See Table 10 for the complete list of register addresses. Setting Bit B10 to 0 selects a read command. The device ignores the subsequent bits (Bits[B9:B0]).

Any conversion event is treated as a special case and overrides a previous read command. The AD7091R-2/AD7091R-4/AD7091R-8 always drive out the conversion result register on SDO after a conversion even though a register read was initiated in the previous SPI frame.

Table 25. Write Command Message Configuration

MSB														LSB	
B15	B14	B13	B12	B11	B10	B9	B8	B7	B6	B5	B4	B3	B2	B1	B0
Register Address[4:0]					1	Data[9:0]									

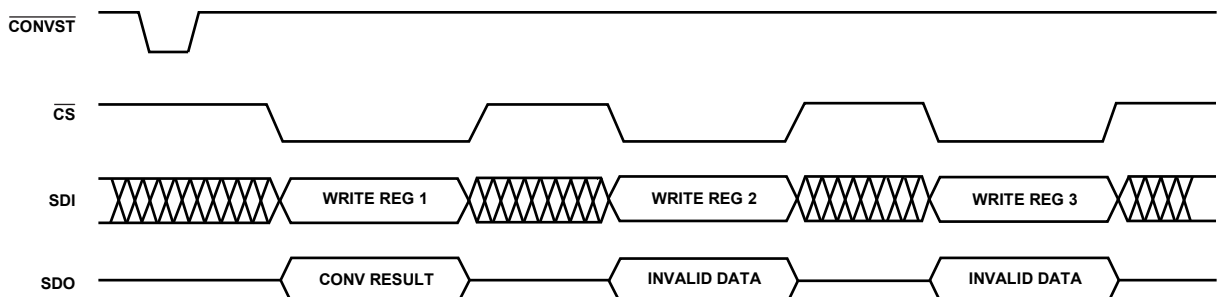

Figure 51. Serial Interface Register Write

Table 26. Read Command Message Configuration

MSB															LSB
B15	B14	B13	B12	B11	B10	B9	B8	B7	B6	B5	B4	B3	B2	B1	B0
Register Address[4:0]					0	Don't Care									

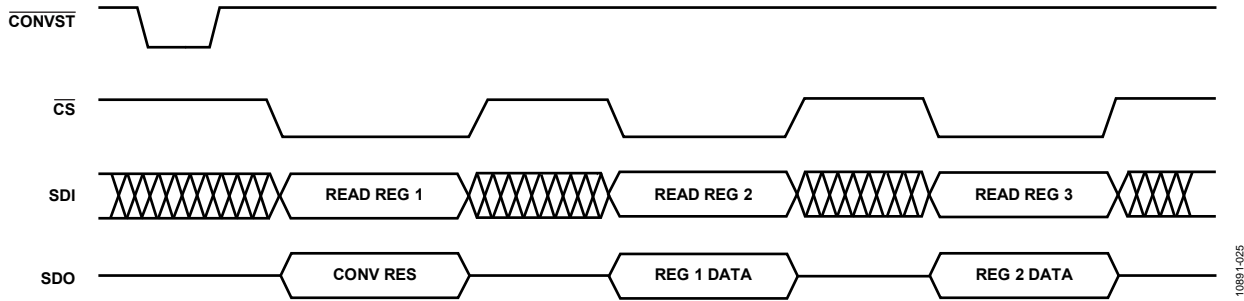

Figure 52. Serial Interface Register Read

100891-025

### POWER-ON DEVICE INITIALIZATION

In lieu of applying a pulse to the  $\overline{\text{RESET}}$  pin from the digital host at initial power up, it is possible to replicate the behavior of the hardware reset function through the application of an alternative stimulus to the  $\overline{\text{CONVST}}$  pin. Once the internal regulator voltage has been established by  $V_{\text{DD}}$  reaching a voltage of 2.1 V, a series of  $\overline{\text{CONVST}}$  pulses must be sent to the ADC. Following the subsequent procedure will reset the device, allowing for proper and expected operation.

To issue a software initialization,

1. Establish the  $V_{\text{DD}}$  and  $V_{\text{DRIVE}}$  supplies for the AD7091R-2/AD7091R-4/AD7091R-8. The power-on time will depend upon the supply pin decoupling load and drive strength of the supply resource.
2. Provide 66 pulses on the  $\overline{\text{CONVST}}$  pin that are spaced a minimum of 2  $\mu\text{s}$  apart. The pulse width on the  $\overline{\text{CONVST}}$  pin must adhere to the  $t_{\text{CNVPW}}$  timing specification.
3. At the end of the 66<sup>th</sup> pulse, the ADC is initialized and in a ready state. The device can now be configured by the user.

4. At this point, all internal registers will be in an unknown state. Write the desired device configuration as described in the Writing Data to the Registers section. To place all write enabled internal registers in a known state, writing to all device registers is required.
5. Reset the read-only registers by activating the software reset bit of the Configuration Register when performing the write actions described in Step 4. See details in the Configuration Register section.

If using the on-chip internal reference, to meet specified performance, the user should wait until the reference capacitor is fully charged. The reference buffer requires 50 ms to power up and charge the 2.2  $\mu\text{F}$  decoupling capacitor during the power-up time.

In digital pin limited applications, the  $\overline{\text{RESET}}$  pin of the AD7091R-2/AD7091R-4/AD7091R-8 should be tied to the  $V_{\text{DRIVE}}$  supply either directly or via a pull-up resistor.

Figure 53 shows the timing diagram for this operation.

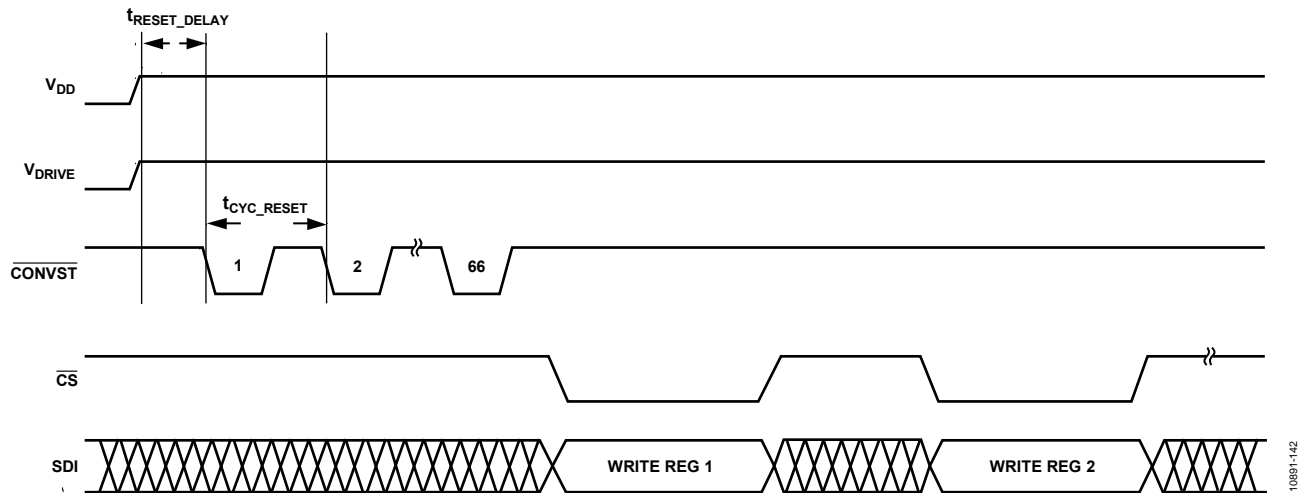

Figure 53. Power On Software Reset Timing



## MODES OF OPERATION

### NORMAL MODE

The user controls whether the device remains in normal mode or enters power-down mode. These modes of operation provide flexible power management options, allowing optimization of the power dissipation and throughput rate ratio for different application requirements.

To achieve the fastest throughput rate performance, use normal mode. Power-up times are not an issue for the AD7091R-2/AD7091R-4/AD7091R-8 because they remain fully powered at all times. Figure 54 shows the general diagram of the AD7091R-2/AD7091R-4/AD7091R-8 in normal mode. The conversion initiates on the falling edge of  $\overline{\text{CONVST}}$ , as described in the Serial Port Interface section. To ensure that the device remains fully powered up at all times, return  $\overline{\text{CONVST}}$  high before  $t_{\text{CONVERT}}$  and keep it high until the conversion has finished. The end of conversion (EOC) point shown in Figure 54 indicates the end of EOC and the moment when the logic level of  $\overline{\text{CONVST}}$  is tested.

To read back data stored in the conversion result register, wait until the conversion is completed. Then, take  $\overline{\text{CS}}$  low, and the conversion data clocks out on the SDO pin. The output shift register is 16 bits wide. Data is shifted out of the device as a 16-bit word under the control of the serial clock (SCLK) input. The full timing diagram for this operation is shown in Figure 4. When the conversion read is completed, pull  $\overline{\text{CONVST}}$  low again to start another conversion.

### POWER-DOWN MODE

When slower throughput rates and lower power consumption are required, use power-down mode by either powering down the ADC between each conversion or by performing a series of conversions at a high throughput rate and then powering down the ADC for a relatively long duration between these burst conversions. When the AD7091R-2/AD7091R-4/AD7091R-8 are in power-down mode, all analog circuitry power down; however, the serial interface is active.

To enter power-down mode, write to the power-down configuration bits in the configuration register, as seen in Table 15. To enter full power-down mode, set the sleep mode/bias generator bit to 1, and set the internal reference bit to 0, which ensures that all analog circuitry and the internal reference power down. When the internal reference is enabled, it consumes power anytime Bit 0 of the configuration register is set to 1.

The serial interface of the AD7091R-2/AD7091R-4/AD7091R-8 is functional in power-down; therefore, the user can read back the results of the conversion after the device enters power-down mode.

To exit this mode of operation and to power up the AD7091R-2/AD7091R-4/AD7091R-8 again, write to the power-down configuration bits in the configuration register (see Table 15). On the rising edge of  $\overline{\text{CONVST}}$ , the device begins to power up. The power-up time of the AD7091R-2/AD7091R-4/AD7091R-8 is typically 1  $\mu\text{s}$ . After power-up is complete, the ADC is fully powered up, and the input signal is properly acquired. To start the next conversion, operate the interface as described in the Normal Mode section. When using the internal reference, and the device is in full power-down mode, the user must wait to perform conversions until the internal reference has had time to power up and settle. The reference buffer requires 50 ms to power up and charge the 2.2  $\mu\text{F}$  decoupling capacitor during the power-up time.

By using the power-down mode on the AD7091R-2/AD7091R-4/AD7091R-8 when this device is not converting, the average power consumption of the ADC decreases at lower throughput rates. Use power-down mode with lower throughput rates. When there is not a significant time interval between bursts of conversions, use normal mode (see the Normal Mode section).

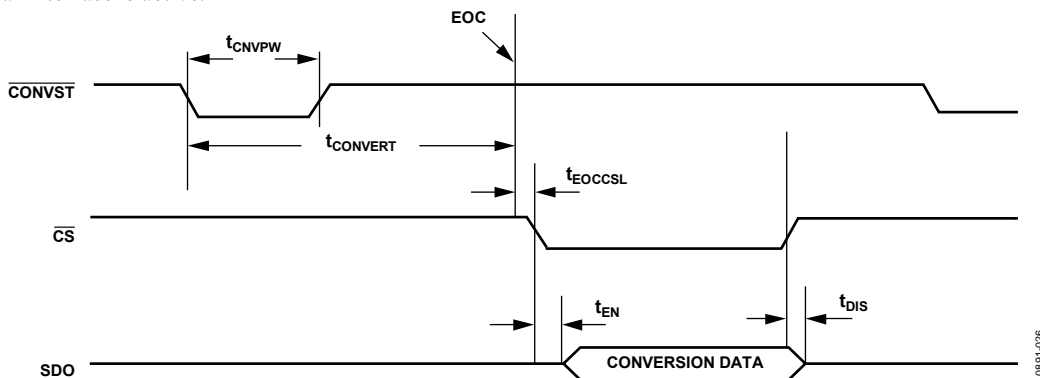

Figure 54. Serial Interface Read Timing in Normal Mode

10891426

**ALERT (AD7091R-4 AND AD7091R-8 ONLY)**

The alert functionality is used as an out-of-range indicator. An alert event is triggered when the value in the conversion result register exceeds the CHx HIGH LIMIT value in the channel high limit register or falls below the CHx LOW LIMIT value in the channel low limit register for a selected channel.

Detailed alert information is accessible in the alert register. The register contains two status bits per channel, one corresponding to the high limit, and the other to the low limit. A logical OR of alert signals for all channels creates a common alert value. This value can be accessed by the alert bit in the conversion result register and configured to drive out on the ALERT function of the ALERT/BUSY/GPO<sub>0</sub> pin. The ALERT/BUSY/GPO<sub>0</sub> pin is configured as ALERT by configuring the following bits in the configuration register:

- Set the ALERT\_EN\_OR\_GPO0 bit, Bit 4, to 1.
- Set the BUSY bit, Bit 5, to 0.
- Set the ALERT\_POL\_OR\_GPO0 bit, Bit 3, to 0 for the ALERT function of the ALERT/BUSY/GPO<sub>0</sub> pin to be active low, and set it to 1 for the ALERT function of the ALERT/BUSY/GPO<sub>0</sub> pin to be active high.

The alert register, alert bit, and the ALERT function of the ALERT/BUSY/GPO<sub>0</sub> pin are cleared by reading the alert register contents. Additionally, if the conversion result goes beyond the hysteresis value for a selected channel, the alert bit corresponding to that channel is reset automatically. The automatic clearing of the alert status can be disabled by setting the ALERT\_STICKY bit in the configuration register to 1. If the ALERT\_STICKY bit is set when an alert occurs, it can only be reset by a read of the alert register. Issuing a software reset also clears the alert status.

The ALERT/BUSY/GPO<sub>0</sub> pin has an open-drain configuration that allows the alert outputs of several AD7091R-4/AD7091R-8 devices to be wired together when the ALERT function of the ALERT/BUSY/GPO<sub>0</sub> pin is active low. The ALERT\_DRIVE\_TYPE bit (Bit 6) of the configuration register controls the ALERT/BUSY/GPO<sub>0</sub> pin configuration.

Use the ALERT\_POL\_OR\_GPO0 bit (Bit 3) of the configuration register to set the active polarity of the alert output. The power-up default is active low.

When using the ALERT function of the ALERT/BUSY/GPO<sub>0</sub> pin and the open-drain configuration, an external pull-up resistor is required. Connect the external pull-up resistor to V<sub>DRIVE</sub>. The resistor value is application dependent; however, it must be large enough to avoid excessive sink currents when the ALERT function of the ALERT/BUSY/GPO<sub>0</sub> pin is triggered.

**BUSY (AD7091R-4 AND AD7091R-8 ONLY)**

When configuring the ALERT/BUSY/GPO<sub>0</sub> pin as a BUSY output, use the pin to indicate when a conversion is taking place. To configure the ALERT/BUSY/GPO<sub>0</sub> pin as BUSY, use the following bits in the configuration register:

- Set the ALERT\_EN\_OR\_GPO0 bit, Bit 4, to 1.
- Set the BUSY bit, Bit 5, to 1.
- Set the ALERT\_POL\_OR\_GPO0 bit, Bit 3, to 0 for the BUSY pin to be active low, and set it to 1 for the BUSY pin to be active high.

When using the BUSY function of the ALERT/BUSY/GPO<sub>0</sub> pin, an external pull-up resistor is required because the output is an open-drain configuration. Connect the external pull-up resistor to V<sub>DRIVE</sub>. The resistor value is application dependent; however, it must be large enough to avoid excessive sink currents when the BUSY function of the ALERT/BUSY/GPO<sub>0</sub> pin is triggered.

**CHANNEL SEQUENCER**

The AD7091R-2/AD7091R-4/AD7091R-8 include a channel sequencer that is useful for scanning channels in a repeated fashion. Channels included in the sequence are configured in the channel register. If all the bits in the channel register are 0, Channel 0 is selected by default, and all conversions happen on this channel. If the channel register is nonzero, the conversion sequence starts from the lowest numbered channel enabled in

the channel register. The sequence cycles through all the enabled channels in ascending order. After all the channels in the sequence are converted, the sequence starts again.

There is a latency of one conversion before the channel conversion sequence is updated. If the channel register is programmed with a new value, the conversion sequence is reset to the lowest numbered channel in the new value.

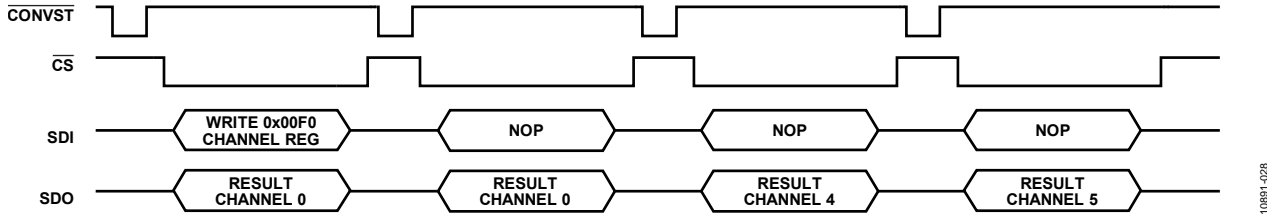

Figure 55. Channel Sequencer

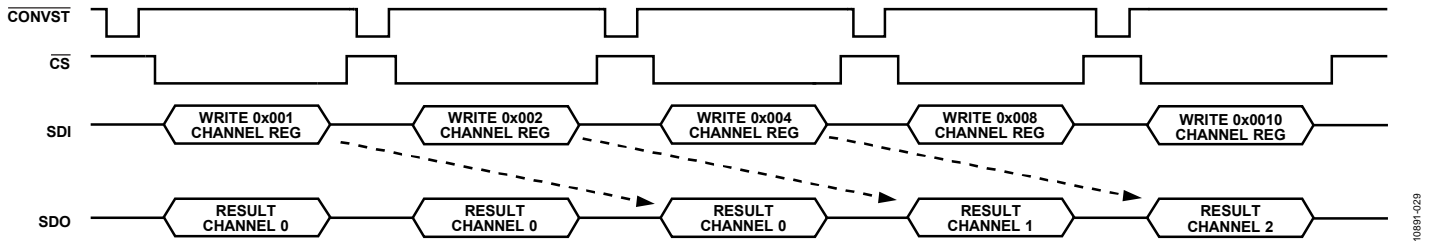

Figure 56. Channel Sequencer Multiple Channel Write

**DAISY CHAIN**

Daisy-chain mode is intended for applications where multiple AD7091R-2/AD7091R-4/AD7091R-8 devices are used. This feature is useful for reducing component count and wiring connections, for example, in isolated multiconverter applications or for systems with a limited interfacing capacity.

All ADC slaves are addressed by the same  $\overline{CS}$ ,  $\overline{CONVST}$ , and SCLK signals. The SDI of the first AD7091R-2/AD7091R-4/AD7091R-8 slave in the chain is driven directly by the master output, slave input (MOSI) pin of the SPI master. The SDO of the first slave is connected to the SDI of the second slave. All the subsequent slaves are connected in this fashion, and the SDO of the last slave drives the master input, slave output (MISO) pin of the master. A connection diagram example using two AD7091R-2/AD7091R-4/AD7091R-8 devices is shown in Figure 57.

Each AD7091R-2/AD7091R-4/AD7091R-8 slave in the chain requires a 16-bit SPI command. If there are N slaves, each SPI frame must have  $N \times 16$  bits of data. In the AD7091R-2/AD7091R-4/AD7091R-8, when the bit counter crosses 16 bits, all of the received bits are sent out over the SDO. The output from the first slave is the input of the second slave. Effectively, each slave ignores all the incoming 16-bit SPI commands except the last one. The SPI command received just before the  $\overline{CS}$  rising edge is the only valid SPI command for a given device in the daisy chain. The output on the next SPI frame is determined by the valid SPI command or any conversion event.

The methods for reading a conversion result to configuring the slave registers are outlined in Figure 58 to Figure 62 for a two-slave example. Additional slave devices can be added to the chain by following the same principles defined for the two-device configuration.

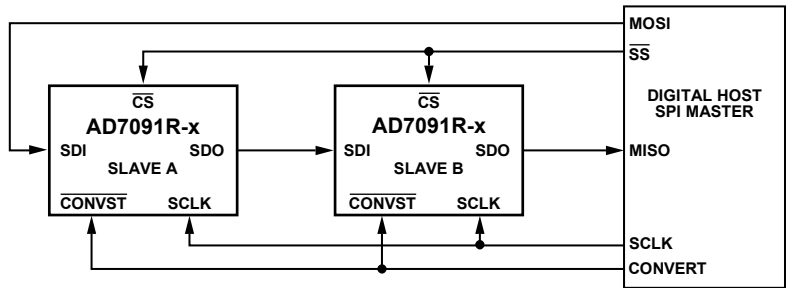

Figure 57. Daisy-Chain Configuration

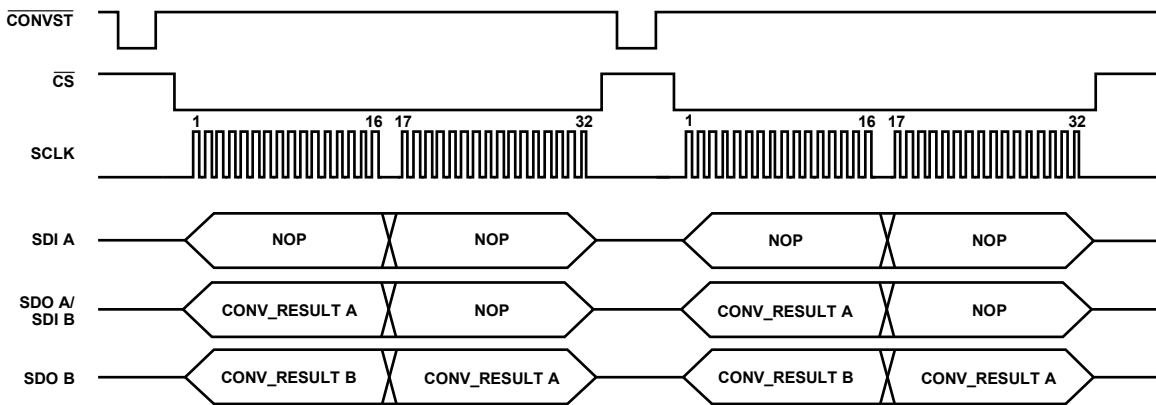

Figure 58. Conversion in a Two-Slave Daisy-Chain Mode Configuration

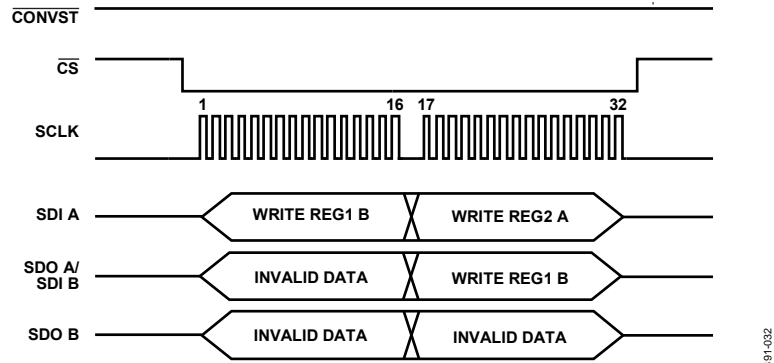

Figure 59. Single Register Write in a Two-Slave Daisy-Chain Mode Configuration

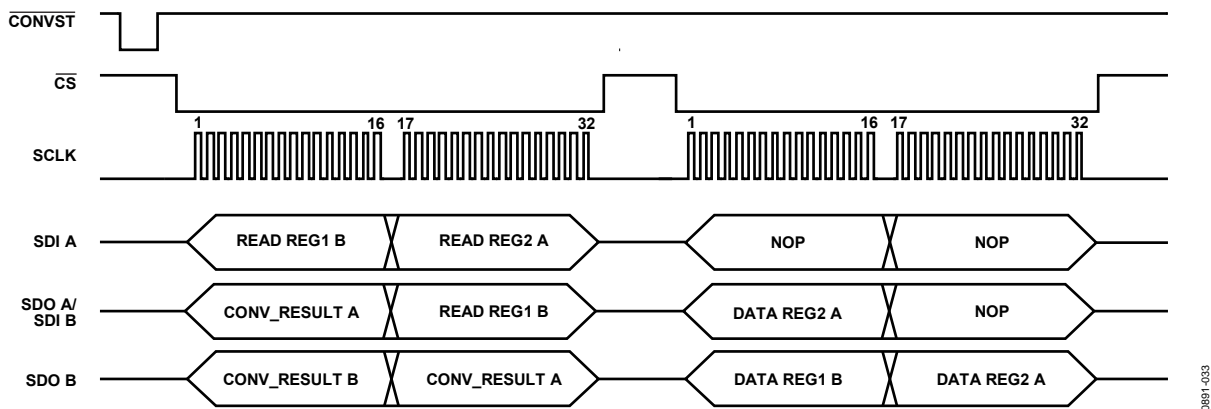

Figure 60. Single Register Read in a Two-Slave Daisy-Chain Mode Configuration

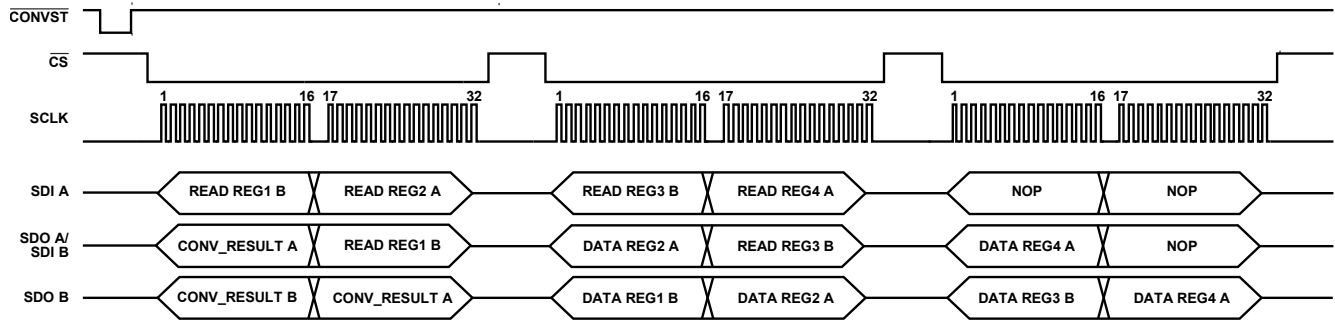

Figure 61. Multiple Register Read in a Two-Slave Daisy-Chain Mode Configuration

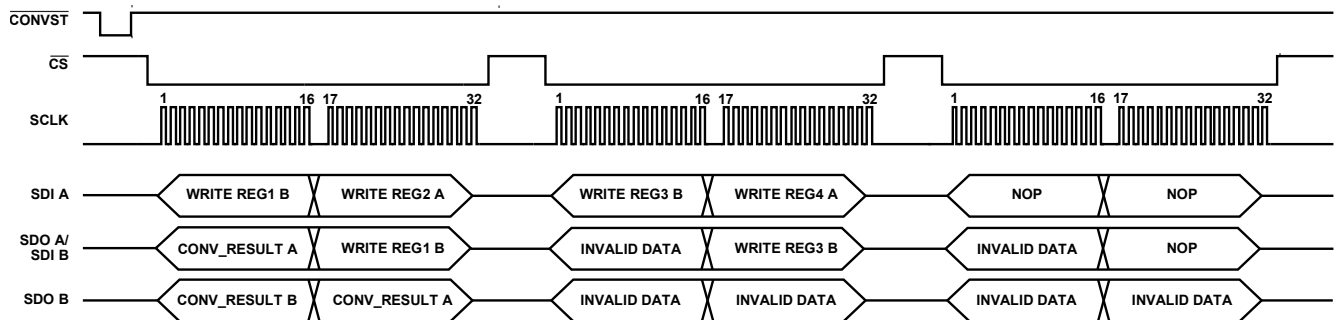
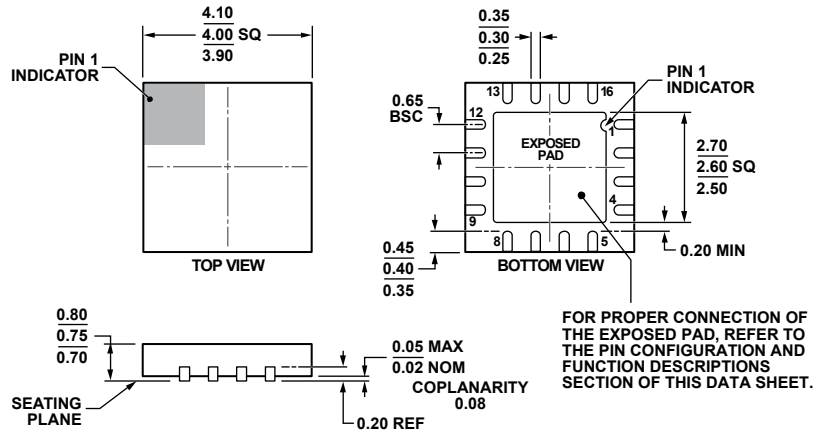
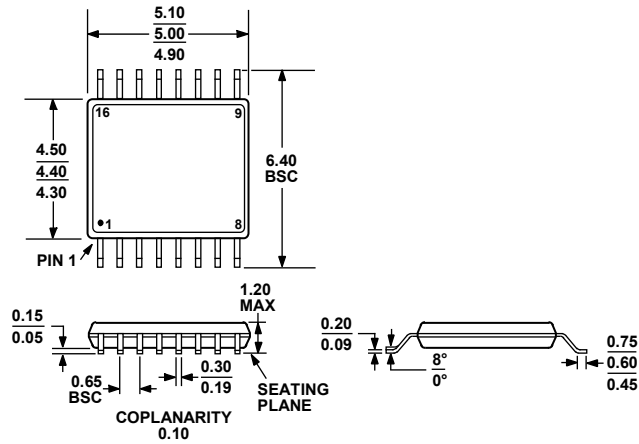

Figure 62. Multiple Register Write in a Two-Slave Daisy-Chain Mode Configuration

OUTLINE DIMENSIONS



COMPLIANT TO JEDEC STANDARDS MO-220-WGGC.  
 Figure 63. 16-Lead Lead Frame Chip Scale Package [LFCSP\_WQ]  
 4 mm × 4 mm Body, Very Very Thin Quad  
 (CP-16-17)  
 Dimensions shown in millimeters



COMPLIANT TO JEDEC STANDARDS MO-153-AB  
 Figure 64. 16-Lead Thin Shrink Small Outline Package [TSSOP]  
 (RU-16)  
 Dimensions shown in millimeters

08-16-2010.C

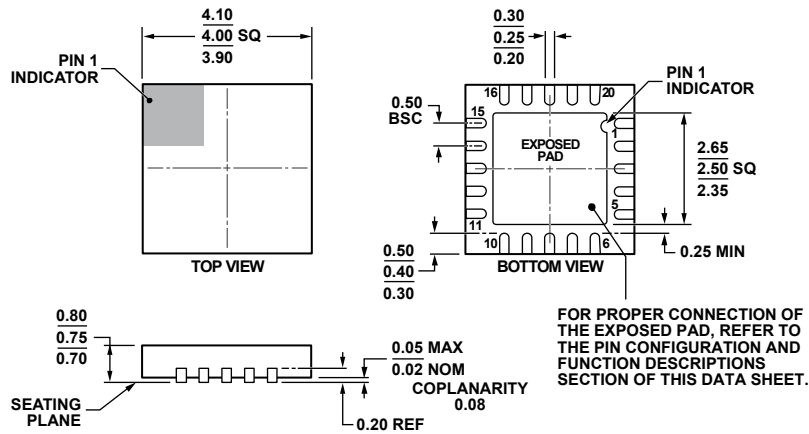

COMPLIANT TO JEDEC STANDARDS MO-220-WGGD.

Figure 65. 20-Lead Lead Frame Chip Scale Package [LFCSP\_WQ]  
4 mm × 4 mm Body, Very Very Thin Quad  
(CP-20-10)  
Dimensions shown in millimeters

061609-B

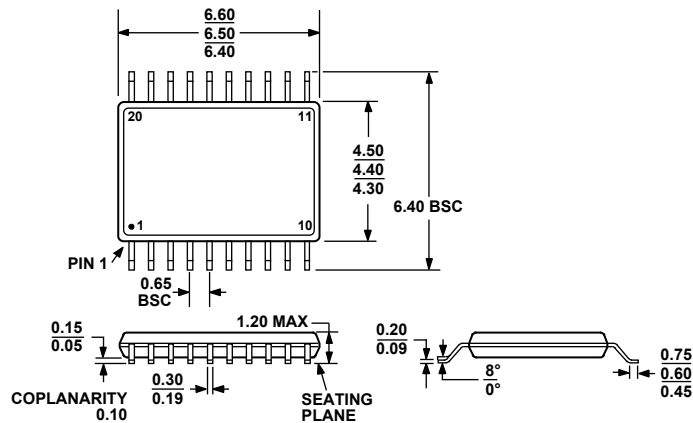

COMPLIANT TO JEDEC STANDARDS MO-153-AC

Figure 66. 20-Lead Thin Shrink Small Outline Package [TSSOP]  
(RU-20)  
Dimensions shown in millimeters

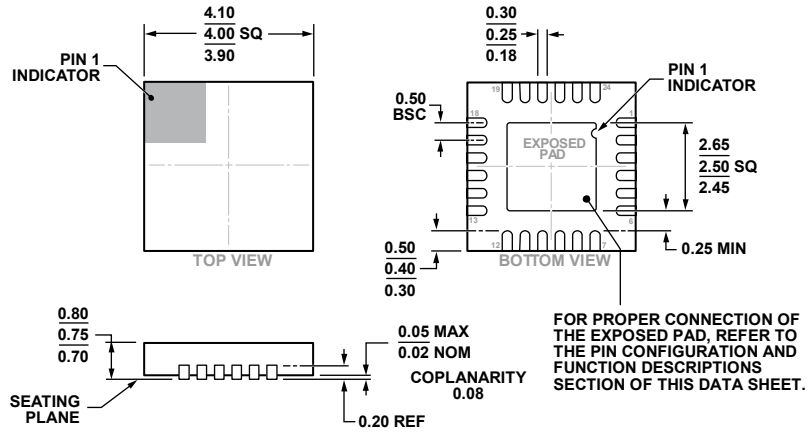

COMPLIANT TO JEDEC STANDARDS MO-220-WGGD.

Figure 67. 24-Lead Lead Frame Chip Scale Package [LFCSP\_WQ]  
4 mm × 4 mm Body, Very Very Thin Quad  
(CP-24-7)

Dimensions shown in millimeters

00-11-2013-A

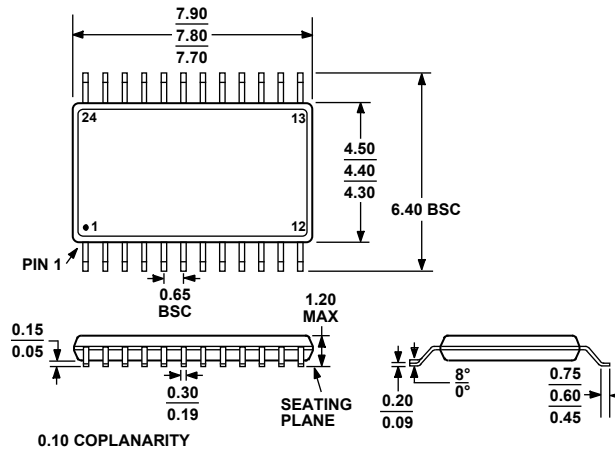

COMPLIANT TO JEDEC STANDARDS MO-153-AD

Figure 68. 24-Lead Thin Shrink Small Outline Package [TSSOP]  
(RU-24)

Dimensions shown in millimeters



## ORDERING GUIDE

Model <sup>1</sup>	Channels	Temperature Range	Package Description	Package Option
AD7091R-2BCPZ	2	-40°C to +125°C	16-Lead Lead Frame Chip Scale Package [LFCSP_WQ]	CP-16-17
AD7091R-2BCPZ-RL7	2	-40°C to +125°C	16-Lead Lead Frame Chip Scale Package [LFCSP_WQ]	CP-16-17
AD7091R-2BRUZ	2	-40°C to +125°C	16-Lead Thin Shrink Small Outline Package [TSSOP]	RU-16
AD7091R-2BRUZ-RL7	2	-40°C to +125°C	16-Lead Thin Shrink Small Outline Package [TSSOP]	RU-16
EVAL-AD7091R-2SDZ			Evaluation Board	
AD7091R-4BCPZ	4	-40°C to +125°C	20-Lead Lead Frame Chip Scale Package [LFCSP_WQ]	CP-20-10
AD7091R-4BCPZ-RL7	4	-40°C to +125°C	20-Lead Lead Frame Chip Scale Package [LFCSP_WQ]	CP-20-10
AD7091R-4BRUZ	4	-40°C to +125°C	20-Lead Thin Shrink Small Outline Package [TSSOP]	RU-20
AD7091R-4BRUZ-RL7	4	-40°C to +125°C	20-Lead Thin Shrink Small Outline Package [TSSOP]	RU-20
EVAL-AD7091R-4SDZ			Evaluation Board	
AD7091R-8BCPZ	8	-40°C to +125°C	24-Lead Lead Frame Chip Scale Package [LFCSP_WQ]	CP-24-7
AD7091R-8BCPZ-RL7	8	-40°C to +125°C	24-Lead Lead Frame Chip Scale Package [LFCSP_WQ]	CP-24-7
AD7091R-8BRUZ	8	-40°C to +125°C	24-Lead Thin Shrink Small Outline Package [TSSOP]	RU-24
AD7091R-8BRUZ-RL7	8	-40°C to +125°C	24-Lead Thin Shrink Small Outline Package [TSSOP]	RU-24
EVAL-AD7091R-8SDZ			Evaluation Board	
EVAL-SDP-CB1Z			Evaluation Controller Board	

<sup>1</sup> Z = RoHS Compliant Part.