

## Ordering Information

Part Number		Temperature Range	Package	Configuration
Standard	Pb-Free			
MIC4426BM	MIC4426YM	-40°C to +85°C	8-Pin SOIC	Dual Inverting
MIC4426CM	MIC4426ZM	-0°C to +70°C	8-Pin SOIC	Dual Inverting
MIC4426BMM	MIC4426YMM	-40°C to +85°C	8-Pin MSOP	Dual Inverting
MIC4426BN	MIC4426YN	-40°C to +85°C	8-Pin PDIP	Dual Inverting
MIC4426CN	MIC4426ZN	-0°C to +70°C	8-Pin PDIP	Dual Inverting
MIC4427BM	MIC4427YM	-40°C to +85°C	8-Pin SOIC	Dual Non-Inverting
MIC4427CM	MIC4427ZM	-0°C to +70°C	8-Pin SOIC	Dual Non-Inverting
MIC4427BMM	MIC4427YMM	-40°C to +85°C	8-Pin MSOP	Dual Non-Inverting
MIC4427BN	MIC4427YN	-40°C to +85°C	8-Pin PDIP	Dual Non-Inverting
MIC4427CN	MIC4427ZN	-0°C to +70°C	8-Pin PDIP	Dual Non-Inverting
MIC4428BM	MIC4428YM	-40°C TO +85°C	8-Pin SOIC	Inverting + Non-Inverting
MIC4428CM	MIC4428ZM	-0°C to +70°C	8-Pin SOIC	Inverting + Non-Inverting
MIC4428BMM	MIC4428YMM	-40°C to +85°C	8-Pin MSOP	Inverting + Non-Inverting
MIC4428BN	MIC4428YN	-40°C to +85°C	8-Pin PDIP	Inverting + Non-Inverting
MIC4428CN	MIC4428ZN	-0°C to +70°C	8-Pin PDIP	Inverting + Non-Inverting

**Note**

DESC standard military drawing 5962-88503 available;

MIC4426, CERDIP 8-Pin

SMD#: 5962-8850307PA

Micrel Part Number: 5952-8850307PA

MIC4427, CERDIP 8-Pin

SMD#: 5962-8850308PA

Micrel Part Number: 5952-8850308PA

MIC4428, CERDIP 8-Pin

SMD#: 5962-8850309PA

Micrel Part Number: 5952-8850309PA

**MIC426/427/428 Device Replacement**

Discontinued Number	Replacement
MIC426CM	MIC4426BM
MIC426BM	MIC4426BM
MIC426CN	MIC4426BN
MIC426BN	MIC4426BN
MIC427CM	MIC4427BM
MIC427BM	MIC4427BM
MIC427CN	MIC4427BN
MIC427BN	MIC4427BN
MIC428CM	MIC4428BM
MIC428BM	MIC4428BM
MIC428CN	MIC4428BN
MIC428BN	MIC4428BN

**MIC1426/1427/1428 Device Replacement**

Discontinued Number	Replacement
MIC1426CM	MIC4426BM
MIC1426BM	MIC4426BM
MIC1426CN	MIC4426BN
MIC1426BN	MIC4426BN
MIC1427CM	MIC4427BM
MIC1427BM	MIC4427BM
MIC1427CN	MIC4427BN
MIC1427BN	MIC4427BN
MIC1428CM	MIC4428BM
MIC1428BM	MIC4428BM
MIC1428CN	MIC4428BN
MIC1428BN	MIC4428BN

## Pin Configuration

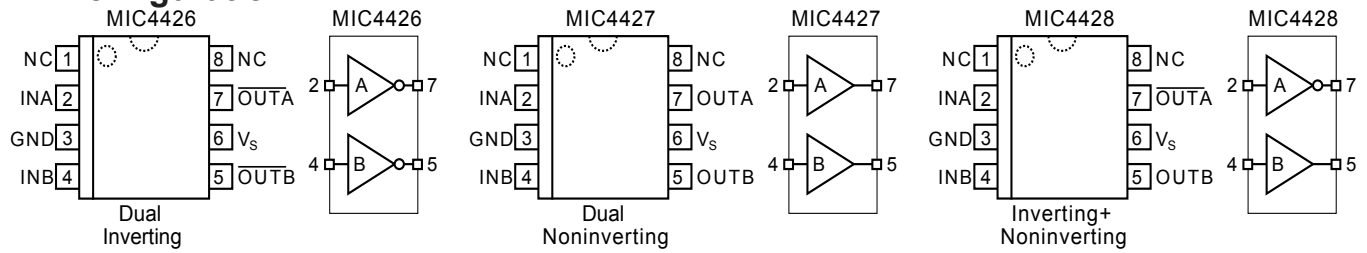

## Pin Description

Pin Number	Pin Name	Pin Function
1, 8	NC	not internally connected
2	INA	Control Input A: TTL/CMOS compatible logic input.
3	GND	Ground
4	INB	Control Input B: TTL/CMOS compatible logic input.
5	OUTB	Output B: CMOS totem-pole output.
6	$V_S$	Supply Input: +4.5V to +18V
7	OUTA	Output A: CMOS totem-pole output.

**Absolute Maximum Ratings<sup>(1)</sup>**

Supply Voltage ( $V_S$ ).....	+22V
Input Voltage ( $V_{IN}$ ).....	$V_S + 0.3V$ to GND – 5V
Junction Temperature ( $T_J$ ).....	150°C
Storage Temperature.....	–65°C to +150°C
Lead Temperature (10 sec.).....	300°C
ESD Rating <sup>(3)</sup>	

**Operating Ratings<sup>(2)</sup>**

Supply Voltage ( $V_S$ ).....	+4.5V to +18V
Temperature Range ( $T_A$ )	
(A).....	–55°C to +125°C
(B).....	–40°C to +85°C
Package Thermal Resistance	
PDIP $\theta_{JA}$ .....	130°C/W
PDIP $\theta_{JC}$ .....	42°C/W
SOIC $\theta_{JA}$ .....	120°C/W
SOIC $\theta_{JC}$ .....	75°C/W
MSOP $\theta_{JA}$ .....	250°C/W

**Electrical Characteristics<sup>(4)</sup>**

4.5V  $\leq V_S \leq 18V$ ;  $T_A = 25^\circ C$ , **bold** values indicate full specified temperature range; unless noted.

Symbol	Parameter	Condition	Min	Typ	Max	Units
<b>Input</b>						
$V_{IH}$	Logic 1 Input Voltage		2.4 <b>2.4</b>	1.4 <b>1.5</b>		V V
$V_{IL}$	Logic 0 Input Voltage			1.1 <b>1.0</b>	0.8 <b>0.8</b>	V V
$I_{IN}$	Input Current	$0 \leq V_{IN} \leq V_S$	<b>-1</b>		<b>1</b>	$\mu A$
<b>Output</b>						
$V_{OH}$	High Output Voltage		$V_S - 0.025$			V
$V_{OL}$	Low Output Voltage				<b>0.025</b>	V
$R_O$	Output Resistance	$I_{OUT} = 10mA, V_S = 18V$		6 <b>8</b>	10 <b>12</b>	$\Omega$ $\Omega$
$I_{PK}$	Peak Output Current			<b>1.5</b>		A
I	Latch-Up Protection	withstand reverse current	<b>&gt;500</b>			mA
<b>Switching Time</b>						
$t_R$	Rise Time	test Figure 1		18 <b>20</b>	30 <b>40</b>	ns ns
$t_F$	Fall Time	test Figure 1		15 <b>29</b>	20 <b>40</b>	ns ns
$t_{D1}$	Delay Time	test Figure 1		17 <b>19</b>	30 <b>40</b>	ns ns
$t_{D2}$	Delay Time	test Figure 1		23 <b>27</b>	50 <b>60</b>	ns <b>ns</b>
$t_{PW}$	<b>Pulse Width</b>	<b>test Figure 1</b>	<b>400</b>			ns
<b>Power Supply</b>						
$I_S$	Power Supply Current	$V_{INA} = V_{INB} = 3.0V$	0.6	1.4 <b>1.5</b>	4.5 <b>8</b>	mA mA
$I_S$	Power Supply Current	$V_{INA} = V_{INB} = 0.0V$		0.18 <b>0.19</b>	0.4 <b>0.6</b>	mA mA

**Notes:**

1. Exceeding the absolute maximum rating may damage the device.
2. The device is not guaranteed to function outside its operating rating.
3. Devices are ESD sensitive. Handling precautions recommended.
4. Specification for packaged product only.

Test Circuits

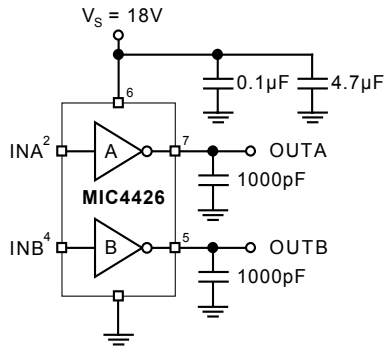

Figure 1a. Inverting Configuration

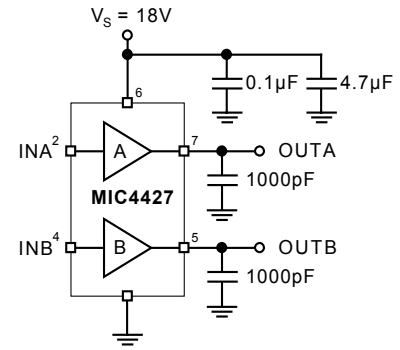

Figure 2a. Noninverting Configuration

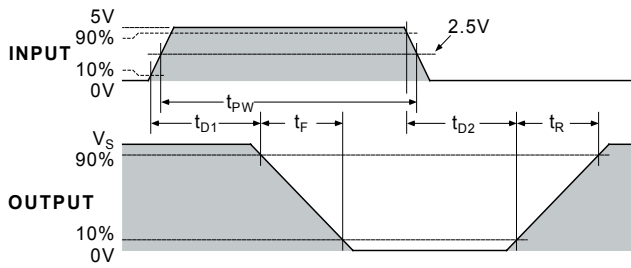

Figure 1b. Inverting Timing

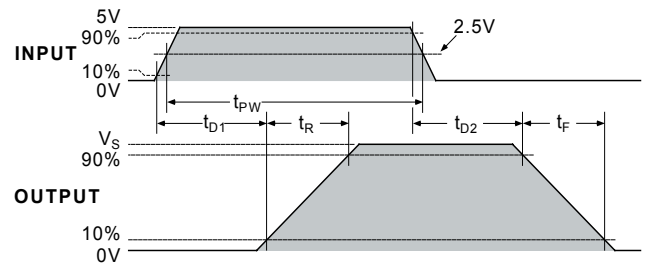
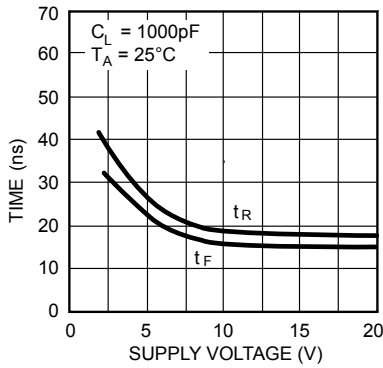

Figure 2b. Noninverting Timing

# Electrical Characteristics

Rise and Fall Time vs. Supply Voltage



Delay Time vs. Supply Voltage

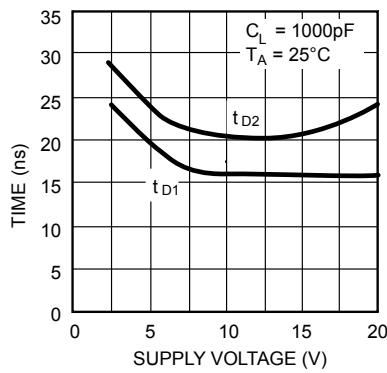

Rise and Fall Time vs. Temperature

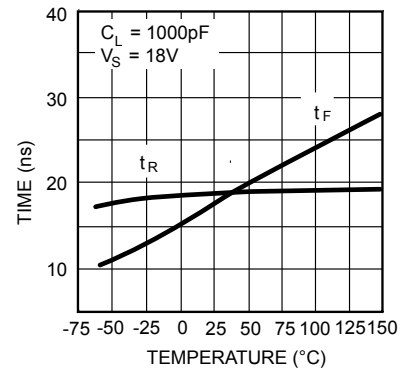

Delay Time vs. Temperature

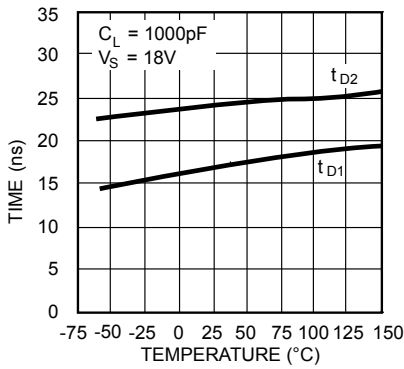

Supply Current vs. Capacitive Load

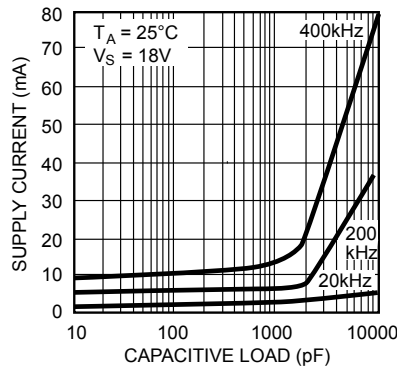

Rise and Fall Time vs. Capacitive Load

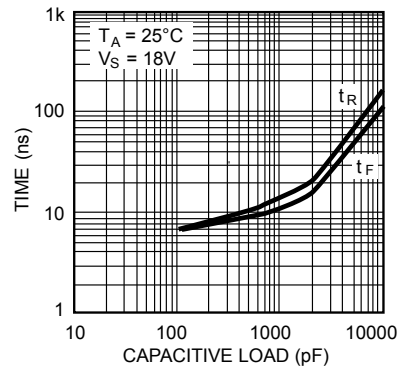

Supply Current vs. Frequency

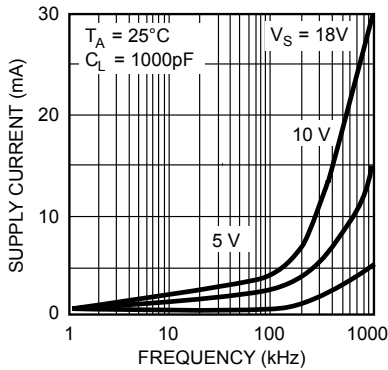

High Output vs. Current

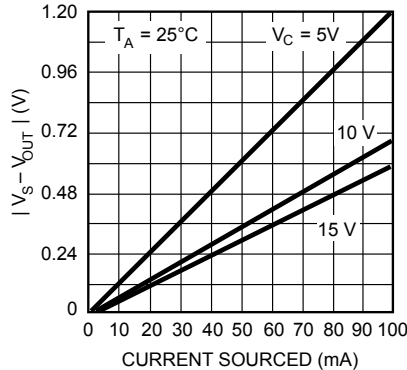

Low Output vs. Current

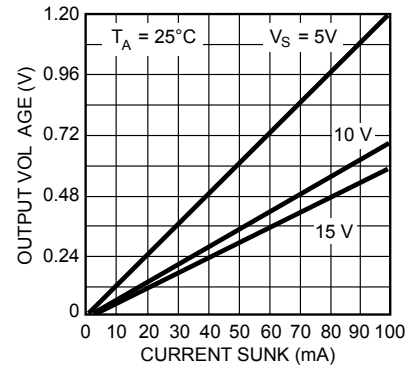

Quiescent Power Supply Current vs. Supply Voltage

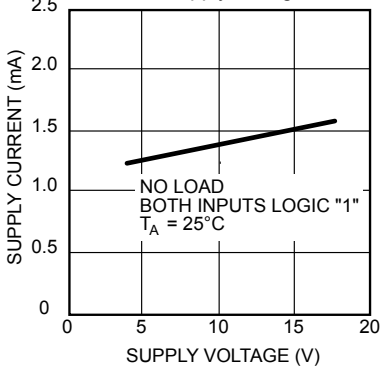

Quiescent Power Supply Current vs. Supply Voltage

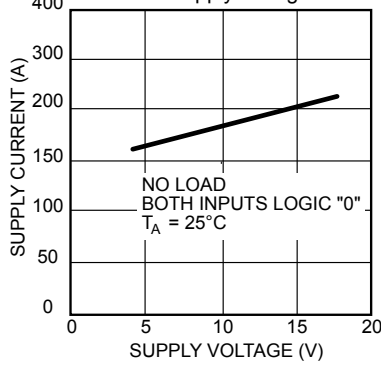

Package Power Dissipation

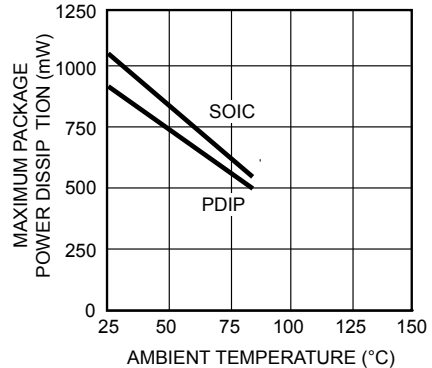

## Applications Information

### Supply Bypassing

Large currents are required to charge and discharge large capacitive loads quickly. For example, changing a 1000pF load by 16V in 25ns requires 0.8A from the supply input.

To guarantee low supply impedance over a wide frequency range, parallel capacitors are recommended for power supply bypassing. Low-inductance ceramic MLC capacitors with short lead lengths (< 0.5") should be used. A 1.0μF film capacitor in parallel with one or two 0.1μF ceramic MLC capacitors normally provides adequate bypassing.

### Grounding

When using the inverting drivers in the MIC4426 or MIC4428, individual ground returns for the input and output circuits or a ground plane are recommended for optimum switching speed. The voltage drop that occurs between the driver's ground and the input signal ground, during normal high-current switching, will behave as negative feedback and degrade switching speed.

### Control Input

Unused driver inputs must be connected to logic high (which can be  $V_S$ ) or ground. For the lowest quiescent current (< 500μA), connect unused inputs to ground. A logic-high signal will cause the driver to draw up to 9mA.

The drivers are designed with 100mV of control input hysteresis. This provides clean transitions and minimizes output stage current spikes when changing states. The control input voltage threshold is approximately 1.5V. The control input recognizes 1.5V up to  $V_S$  as a logic high and draws less than 1μA within this range.

The MIC4426/7/8 drives the TL494, SG1526/7, MIC38C42, TSC170 and similar switch-mode power supply integrated circuits.

### Power Dissipation

Power dissipation should be calculated to make sure that the driver is not operated beyond its thermal ratings. Quiescent power dissipation is negligible. A practical value for total power dissipation is the sum of the dissipation caused by the load and the transition power dissipation ( $P_L + P_T$ ).

### Load Dissipation

Power dissipation caused by continuous load current (when driving a resistive load) through the driver's output resistance is:

$$P_L = I_L^2 R_O$$

For capacitive loads, the dissipation in the driver is:

$$P_L = f C_L V_S^2$$

### Transition Dissipation

In applications switching at a high frequency, transition power dissipation can be significant. This occurs during switching transitions when the P-channel and N-channel output FETs are both conducting for the brief moment when one is turning on and the other is turning off.

$$P_T = 2 f V_S Q$$

Charge (Q) is read from the following graph:

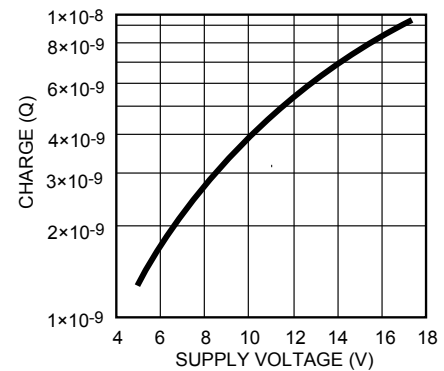

**Crossover Energy Loss per Transition**

Package Information

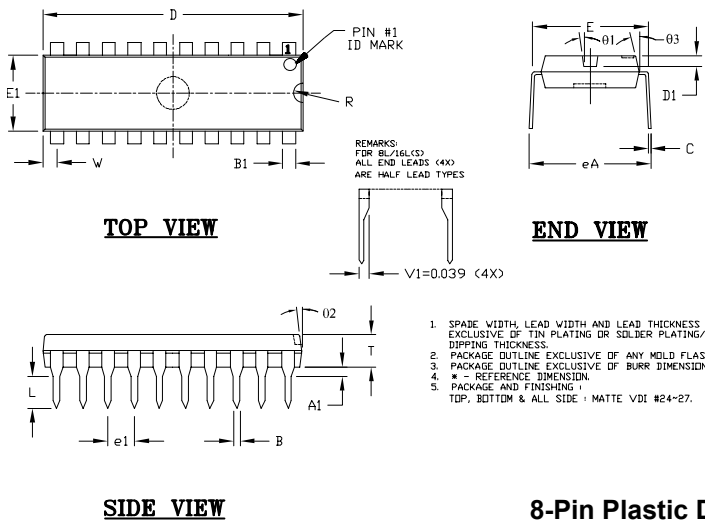
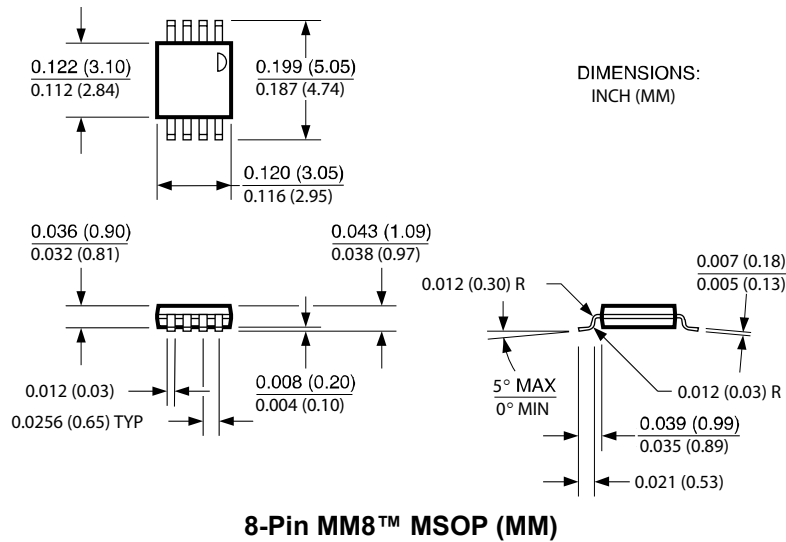
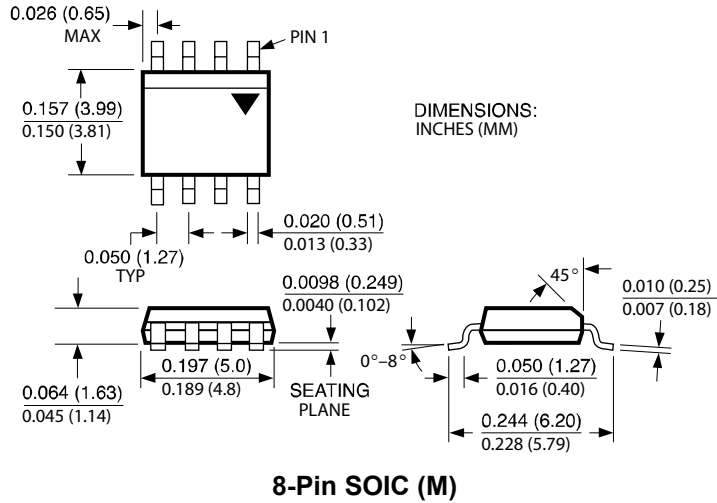

LEAD TYPE		8LD	14/16LD	18LD	20LD
STAND-OFF	A1	0.015 MIN	0.015 MIN	0.015 MIN	0.015 MIN
LEAD WIDTH *	B	0.018	0.018	0.018	0.018
SPADE WIDTH *	B1	0.060	0.060	0.060	0.060
LEAD THICKNESS *	C	0.010	0.010	0.010	0.010
<b>LENGTH TOL ±0.004</b>	D	0.375	0.750	0.890	1.020
IDENT DEPTH	D1	0.030 ~ 0.060	0.030 ~ 0.060	0.030 ~ 0.060	0.030 ~ 0.060
SHOULDER WIDTH OUTER TO OUTER	E	0.300 ~ 0.325	0.300 ~ 0.325	0.300 ~ 0.325	0.300 ~ 0.325
<b>WIDTH TOL ±0.004</b>	E1	0.250	0.250	0.250	0.250
LEAD SPREAD OUTER TO OUTER	eA	0.320 ~ 0.370	0.320 ~ 0.370	0.320 ~ 0.370	0.320 ~ 0.370
LEAD PITCH *	e1	0.100	0.100	0.100	0.100
<b>LEAD LENGTH TOL ±0.004</b>	L	0.125	0.125	0.125	0.125
IDENT RADIUS	R	0.030	0.030	0.030	0.030
<b>TOTAL THICKNESS TOL ±0.004</b>	T	0.130	0.130	0.130	0.130
LEAD TO END PACKAGE	W	0.025REF	0.075REF14LD 0.025REF16LD	0.045REF	0.060REF
IDENT DRAFT TOL ±3°	Ø1	7°	7°	7°	7°
END ANGLE (4x) TOL ±3°	Ø2	7°	7°	7°	7°
SIDE ANGLE (4x) TOL ±3°	Ø3	7°	7°	7°	7°

---

**MICREL INC. 2180 FORTUNE DRIVE SAN JOSE, CA 95131 USA**  
**TEL + 1 (408) 944-0800 FAX + 1 (408) 474-1000 WEB <http://www.micrel.com>**

This information furnished by Micrel in this data sheet is believed to be accurate and reliable. However no responsibility is assumed by Micrel for its use. Micrel reserves the right to change circuitry and specifications at any time without notification to the customer.

Micrel Products are not designed or authorized for use as components in life support appliances, devices or systems where malfunction of a product can reasonably be expected to result in personal injury. Life support devices or systems are devices or systems that (a) are intended for surgical implant into the body or (b) support or sustain life, and whose failure to perform can be reasonably expected to result in a significant injury to the user. A Purchaser's use or sale of Micrel Products for use in life support appliances, devices or systems is a Purchaser's own risk and Purchaser agrees to fully indemnify Micrel for any damages resulting from such use or sale.

© 2003 Micrel, Incorporated.