

LTC3240-3.3/LTC3240-2.5

ABSOLUTE MAXIMUM RATINGS

(Note 1)

V_{IN} to GND	-0.3V to 6V
V_{OUT} to GND	-0.3V to 5.5V
SHDN to GND	-0.3V to ($V_{IN} + 0.3V$)
V_{OUT} Short-Circuit Duration	Indefinite
Operating Temperature Range (Note 2)	-40°C to 85°C
Storage Temperature Range	-65°C to 125°C
Maximum Junction Temperature	125°C

PACKAGE/ORDER INFORMATION

<p>TOP VIEW</p> <p>DC PACKAGE 6-LEAD (2mm × 2mm) PLASTIC DFN $T_{JMAX} = 125^{\circ}C$, $\theta_{JA} = 80^{\circ}C/W$ (NOTE 4) EXPOSED PAD (PIN 7) IS GND, MUST BE SOLDERED TO PCB</p>	
ORDER PART NUMBER	DC PART MARKING
LTC3240EDC-3.3	LBXJ
LTC3240EDC-2.5	LCBP
Order Options Tape and Reel: Add #TR Lead Free: Add #PBF Lead Free Tape and Reel: Add #TRPBF Lead Free Part Marking: http://www.linear.com/leadfree/	

Consult LTC Marketing for parts specified with wider operating temperature ranges.

ELECTRICAL CHARACTERISTICS

The ● denotes the specifications which apply over the full operating temperature range, otherwise specifications are at $T_A = 25^{\circ}C$, $SHDN = V_{IN}$, $C_{FLY} = 1\mu F$, $C_{IN} = 1\mu F$, $C_{OUT} = 4.7\mu F$ unless otherwise noted.

SYMBOL	PARAMETER	CONDITIONS	MIN	TYP	MAX	UNITS
V_{IN}	Input Voltage Range		● 1.8		5.5	V
V_{OUT}	Output Voltage Range	$1.8V \leq V_{IN} \leq 2.5V$, $I_{OUT} < 40mA$	● 3.168	3.3	3.432	V
		LTC3240-3.3 $2.5V \leq V_{IN} \leq 5.5V$, $I_{OUT} < 150mA$	● 3.168	3.3	3.432	V
		LTC3240-2.5 $1.8V \leq V_{IN} \leq 5.5V$, $I_{OUT} < 60mA$	● 2.4	2.5	2.6	V
I_{IN}	No Load Input Current	$I_{OUT} = 0$, $1.8V \leq V_{IN} \leq 5.5V$		65	100	μA
I_{SHDN}	Shutdown Current	$SHDN = 0V$, $V_{OUT} = 0V$		0.1	1	μA
η	Efficiency	$V_{IN} = 2.5V$, $I_{OUT} = 100mA$		64		%
		LTC3240-3.3 $V_{IN} = 3.7V$, $I_{OUT} = 100mA$		87		%
		LTC3240-2.5 $V_{IN} = 2V$, $I_{OUT} = 50mA$		63		%
		$V_{IN} = 3V$, $I_{OUT} = 50mA$		83		%
V_{IH}	SHDN Input High Voltage	$1.8V \leq V_{IN} \leq 5.5V$	● 1.2			V
V_{IL}	SHDN Input Low Voltage	$1.8V \leq V_{IN} \leq 5.5V$	●		0.4	V
I_{IH}	SHDN Input Current	$V_{SHDN} = V_{IN} = 5.5V$	● -1		1	μA
I_{IL}	SHDN Input Current	$V_{SHDN} = 0V$	● -1		1	μA
I_{LIM}	Output Current Limit	$V_{IN} = 3.7V$, $V_{OUT} = 0V$ Step-Down Mode		450		mA
		$V_{IN} = 2.4V$, $V_{OUT} = 0V$ Step-Up Mode		270		mA
t_{ON}	V_{OUT} Turn-On Time	From the Rising Edge of SHDN to 90% of V_{OUT}				
		$V_{IN} = 2.5V$, $R_{LOAD} = 66\Omega$		0.5		ms
		$V_{IN} = 3.7V$, $R_{LOAD} = 66\Omega$		0.4		ms

Step-Up Mode

I_{BURST}	Burst Mode Threshold	$V_{IN} = 2.4V$		15		mA
V_{RIPPLE}	Output Ripple	$I_{OUT} = 100mA$, $V_{OUT} = 2.5V$ or $3.3V$		20		mV _{P-P}
f_{OSC}	Switching Frequency	$V_{IN} = 2.4V$	● 0.6	1.2	1.8	MHz
$V_{RIPPLE(BURST)}$	Burst Mode [®] Output Ripple	$V_{IN} = 2.4V$		20		mV _{P-P}

Burst Mode is a registered trademark of Linear Technology Corporation.

3240fb

ELECTRICAL CHARACTERISTICS

The ● denotes the specifications which apply over the full operating temperature range, otherwise specifications are at $T_A = 25^\circ\text{C}$, $\text{SHDN} = V_{\text{IN}}$, $C_{\text{FLY}} = 1\mu\text{F}$, $C_{\text{IN}} = 1\mu\text{F}$, $C_{\text{OUT}} = 4.7\mu\text{F}$ unless otherwise noted.

SYMBOL	PARAMETER	CONDITIONS	MIN	TYP	MAX	UNITS
R_{OL}	Effective Open-Loop Output Resistance LTC3240-3.3 LTC3240-2.5 (Note 3)	Doubler Mode $V_{\text{IN}} = 1.8\text{V}$, $V_{\text{OUT}} = 3\text{V}$ $V_{\text{IN}} = 1.8\text{V}$, $V_{\text{OUT}} = 2.25\text{V}$		7.5 8.0		Ω Ω

Note 1: Stresses beyond those listed under Absolute Maximum Ratings may cause permanent damage to the device. Exposure to any Absolute Maximum Rating condition for extended periods may affect device reliability and lifetime.

Note 2: The LTC3240-3.3/LTC3240-2.5 are guaranteed to meet performance specifications from 0°C to 85°C . Specifications over the

-40°C to 85°C operating temperature range are assured by design, characterization and correlation with statistical process controls.

Note 3: $R_{\text{OL}} = (2V_{\text{IN}} - V_{\text{OUT}})/I_{\text{OUT}}$

Note 4: Failure to solder the exposed backside of the package to a PCB ground plane will result in a thermal resistance much higher than $80^\circ\text{C}/\text{W}$.

TYPICAL PERFORMANCE CHARACTERISTICS

($T_A = 25^\circ\text{C}$, $C_{\text{FLY}} = C_{\text{IN}} = 1\mu\text{F}$, $C_{\text{OUT}} = 4.7\mu\text{F}$ unless otherwise noted)

Oscillator Frequency vs Supply Voltage (Doubler Mode)

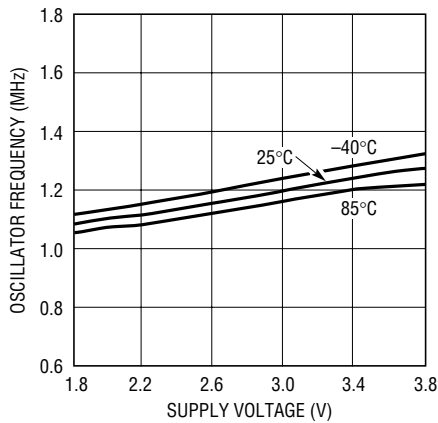

3240 G01

SHDN Threshold Voltage vs Supply Voltage

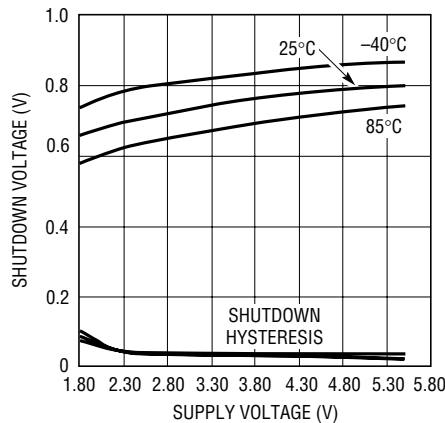

3240 G02

Short-Circuit Current vs Supply Voltage

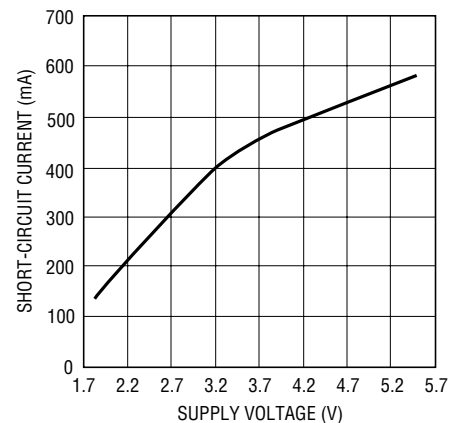

3240 G03

Start-Up Time vs Supply Voltage

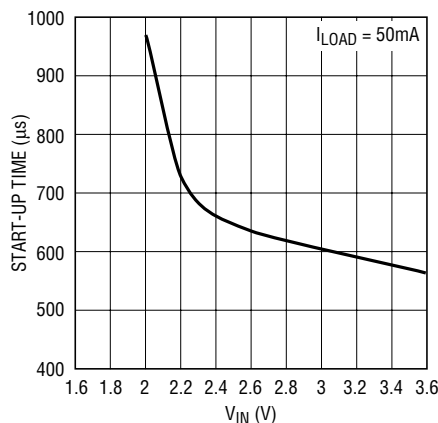

3240 G04

Load Regulation (LTC3240-3.3)

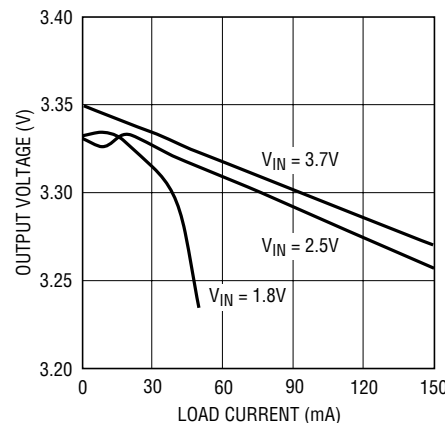

3240 G05

Load Regulation (LTC3240-2.5)

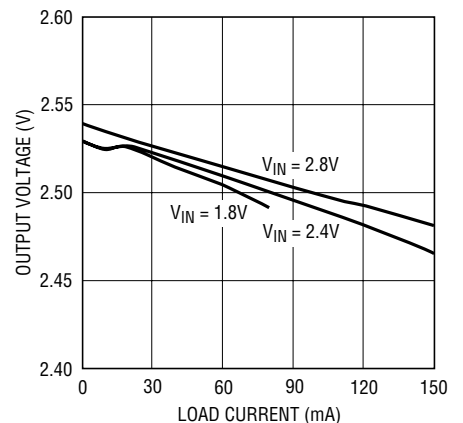

3240 G06

3240fb

LTC3240-3.3/LTC3240-2.5

TYPICAL PERFORMANCE CHARACTERISTICS ($T_A = 25^\circ\text{C}$, $C_{\text{FLY}} = C_{\text{IN}} = 1\mu\text{F}$, $C_{\text{OUT}} = 4.7\mu\text{F}$ unless otherwise noted)

Effective Open-Loop Resistance vs Temperature (LTC3240-3.3)

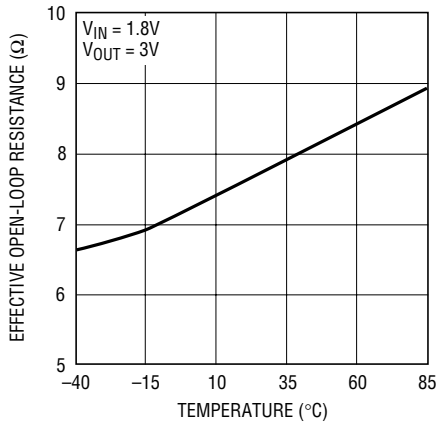

3240 G07

No-Load Input Current vs Supply Voltage (LTC3240-3.3)

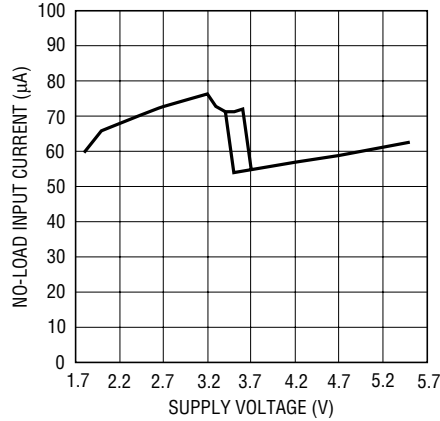

3240 G08

No-Load Input Current vs Supply Voltage (LTC3240-2.5)

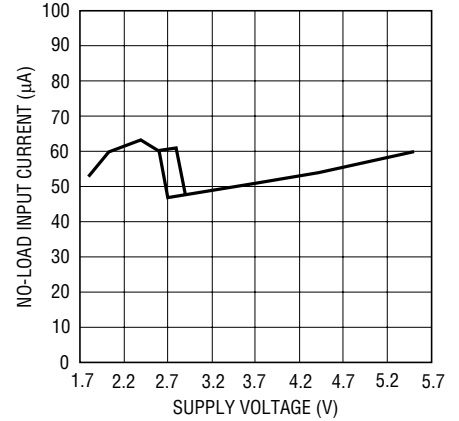

3240 G09

Mode Switch Threshold vs Load Current (LTC3240-3.3)

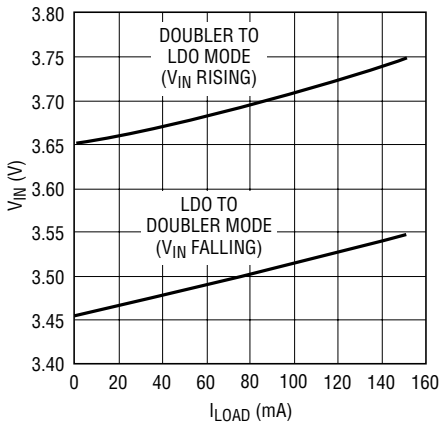

3240 G10

Mode Switch Threshold vs Load Current (LTC3240-2.5)

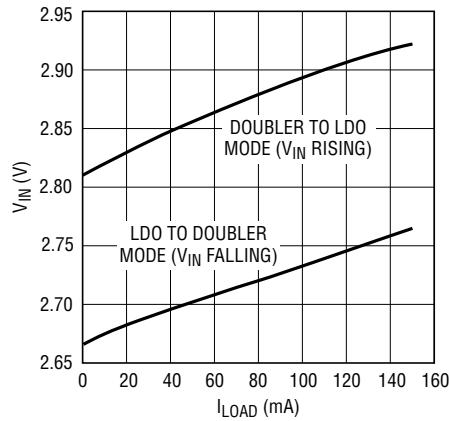

3240 G11

Efficiency vs Supply Voltage (LTC3240-3.3)

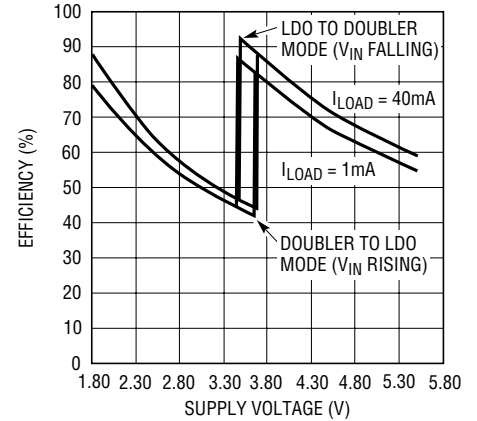

3240 G12

V_{OUT} Soft-Start (LTC3240-3.3)

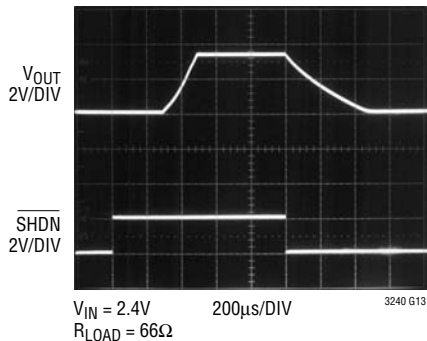

3240 G13

Output Noise/Ripple (LTC3240-3.3)

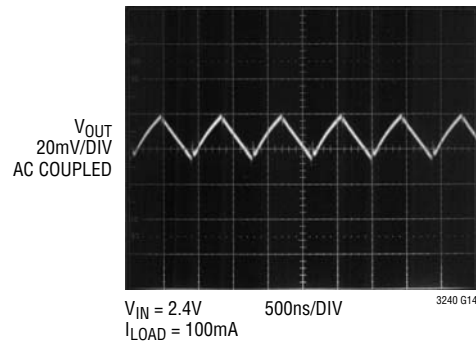

3240 G14

3240fb

TYPICAL PERFORMANCE CHARACTERISTICS ($T_A = 25^\circ\text{C}$, $C_{\text{FLY}} = C_{\text{IN}} = 1\mu\text{F}$, $C_{\text{OUT}} = 4.7\mu\text{F}$ unless otherwise noted)

**Load Transient Response
(LTC3240-3.3)**

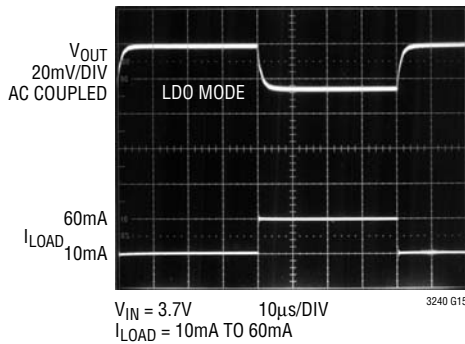

**Output Noise/Ripple
(LTC3240-2.5)**

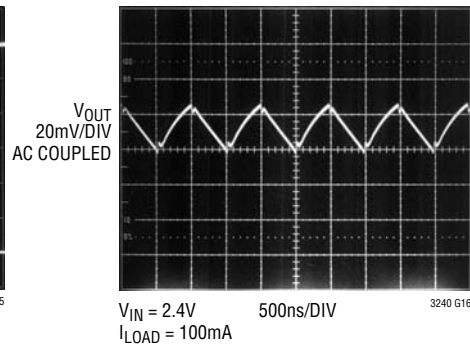

**Load Transient Response
(LTC3240-2.5)**

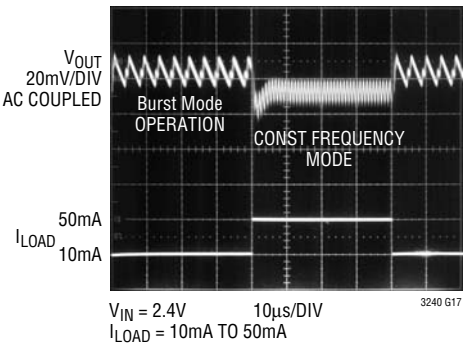

PIN FUNCTIONS

GND (Pin 1): Ground. This pin should be tied to a ground plane for best performance.

V_{IN} (Pin 2): Input Supply Voltage. V_{IN} should be bypassed with a $1\mu\text{F}$ or greater, low ESR ceramic capacitor.

V_{OUT} (Pin 3): Regulated Output Voltage. V_{OUT} should be bypassed with a $4.7\mu\text{F}$ or greater, low ESR ceramic capacitor as close to the pin as possible for best performance.

C^+ (Pin 4): Flying Capacitor Positive Terminal.

C^- (Pin 5): Flying Capacitor Negative Terminal.

$\overline{\text{SHDN}}$ (Pin 6): Active Low Shutdown Input. A low on $\overline{\text{SHDN}}$ disables the LTC3240-3.3/LTC3240-2.5. This pin is a high impedance CMOS input pin which must be driven with valid logic levels. This pin must not be allowed to float.

Exposed Pad (Pin 7): Ground. The exposed pad must be soldered to PCB ground to provide electrical contact and optimum thermal performance.

BLOCK DIAGRAM

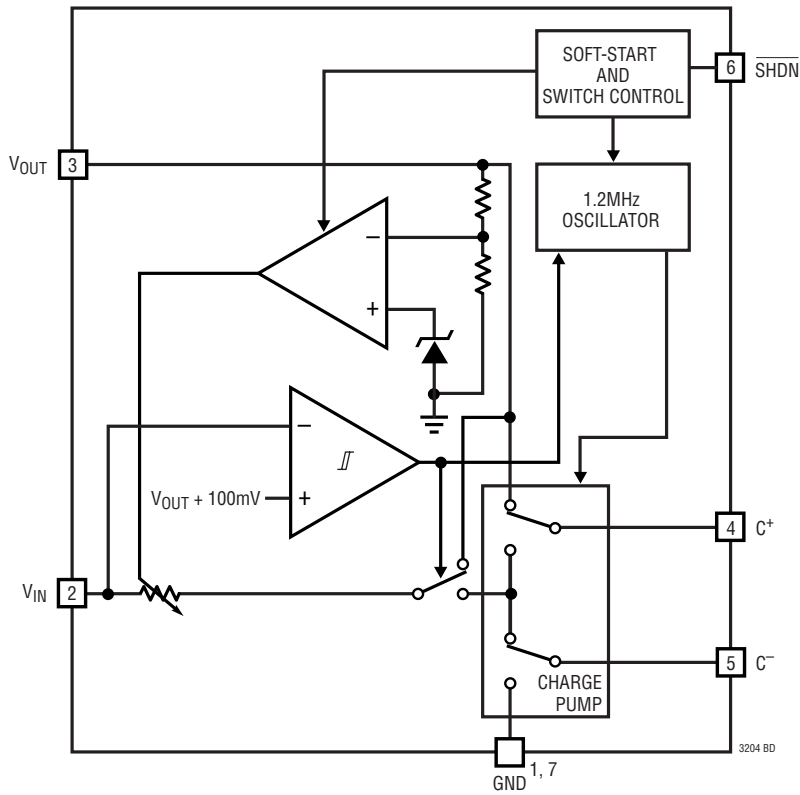

OPERATION (Refer to the Block Diagram)

The LTC3240 is a step-up/step-down charge pump DC/DC converter. For V_{IN} greater than V_{OUT} by about 100mV it operates as a low dropout regulator. Once V_{IN} drops to within 100mV of V_{OUT} , the part automatically switches into charge pump mode to boost V_{IN} to the regulated output voltage. Regulation is achieved by sensing the output voltage through an internal resistor divider and modulating the charge pump output current based on the error signal.

In the charge pump mode a 2-phase nonoverlapping clock activates the charge pump switches. The flying capacitor is charged from V_{IN} on the first phase of the clock. On the second phase of the clock it is stacked in series with V_{IN} and connected to V_{OUT} . This sequence of charging and discharging the flying capacitor continues at a free running frequency of 1.2MHz (typ).

Shutdown Mode

In shutdown mode, all circuitry is turned off and the LTC3240 draws only leakage current from the V_{IN} supply. Furthermore, V_{OUT} is disconnected from V_{IN} . The \overline{SHDN} pin is a CMOS input with a threshold voltage of approximately 0.8V. The LTC3240 is in shutdown when a logic low is applied to the \overline{SHDN} pin. Since the \overline{SHDN} pin is a high impedance CMOS input, it should never be allowed to float. To ensure that its state is defined, it must always be driven with a valid logic level.

Since the output voltage of this device can go above the input voltage, circuitry is required to control the state of the converter even in shutdown. This circuitry will draw an input current of 5 μ A in shutdown. However, this current is eliminated when the output voltage (V_{OUT}) drops to less than approximately 0.8V.

Burst Mode Operation

The LTC3240 provides automatic Burst Mode operation while operating as a charge pump, to increase efficiency of the power converter at light loads. Burst Mode operation

is initiated if the output load current falls below an internally programmed threshold. Once Burst Mode operation is initiated, the part shuts down the internal oscillator to reduce the switching losses, and goes into a low current state. This state is referred to as the sleep state in which the IC consumes only about 65 μ A from the input. When the output voltage droops enough to overcome the burst comparator hysteresis, the part wakes up and commences normal fixed frequency operation recharging the output capacitor. If the output load is still less than the Burst Mode threshold the part will re-enter sleep state. This Burst Mode threshold varies with V_{IN} , V_{OUT} and the choice of output storage capacitor.

Soft-Start

The LTC3240 has built-in soft-start circuitry to prevent excessive current flow during start-up. The soft-start is achieved by internal circuitry that slowly ramps the amount of current available to the output storage capacitor from zero to a value of 300mA over a period of approximately 2ms. The soft-start circuitry is reset in the event of a commanded shutdown or thermal shutdown.

Short-Circuit/Thermal Protection

The LTC3240 has built-in short-circuit current limit as well as overtemperature protection. During a short-circuit condition, the part automatically limits its output current to approximately 300mA. If the junction temperature exceeds approximately 160°C the thermal shutdown circuitry shuts down current delivery to the output. Once the junction temperature drops back to approximately 150°C current delivery to the output is resumed. The LTC3240 will cycle in and out of thermal shutdown indefinitely without latch-up or damage until the short-circuit condition on V_{OUT} is removed. Long term overstress (i.e. operation at junction temperatures above 125°C) should be avoided as it reduces the lifetime of the part and can result in degraded performance.

APPLICATIONS INFORMATION

Power Efficiency

During LDO operation, the power efficiency (η) of the LTC3240 is given by:

$$\eta = \frac{P_{OUT}}{P_{IN}} = \frac{V_{OUT} \cdot I_{OUT}}{V_{IN} \cdot I_{OUT}} = \frac{V_{OUT}}{V_{IN}}$$

At moderate to high output power, the quiescent current of the LTC3240 is negligible and the expression above is valid. For example, the measured efficiency of LTC3240-3.3, with $V_{IN} = 3.7V$, $I_{OUT} = 100mA$ and V_{OUT} regulating to 3.3V is 87% which is in close agreement with the theoretical value of 89%.

During charge pump operation, the power efficiency (η) of the LTC3240 is similar to that of a linear regulator with an effective input voltage of twice the actual input voltage. This occurs because the input current for a voltage doubling charge pump is approximately twice the output current. In an ideal regulating voltage doubler the power efficiency is given by:

$$\eta = \frac{P_{OUT}}{P_{IN}} = \frac{V_{OUT} \cdot I_{OUT}}{V_{IN} \cdot 2I_{OUT}} = \frac{V_{OUT}}{2V_{IN}}$$

At moderate to high output power, the switching losses and the quiescent current of the LTC3240 are negligible and the expression above is valid. For example, the measured efficiency of LTC3240-3.3 with $V_{IN} = 2.5V$, $I_{OUT} = 100mA$ and V_{OUT} regulating to 3.3V is 64% which is in close agreement with the theoretical value of 66%.

Effective Open-Loop Output Resistance (R_{OL})

The effective open-loop output resistance (R_{OL}) of a charge pump is a very important parameter which determines the strength of the charge pump. The value of this parameter depends on many factors such as the oscillator frequency (f_{OSC}), value of the flying capacitor (C_{FLY}), the nonoverlap time, the internal switch resistances (R_S), and the ESR of the external capacitors. A first order approximation for R_{OL} is given below:

$$R_{OL} \cong 2 \sum_{S=1 TO 4} R_S + \frac{1}{f_{OSC} \cdot C_{FLY}}$$

For the LTC3240 in charge pump mode, the maximum available output current and voltage can be calculated from the effective open-loop output resistance, R_{OL} , and the effective output voltage, $2V_{IN(MIN)}$.

From Figure 1, the available current is given by:

$$I_{OUT} = \frac{2V_{IN} - V_{OUT}}{R_{OL}}$$

Typical R_{OL} values as a function of temperature are shown in Figure 2.

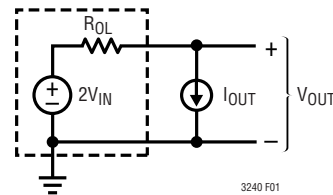

Figure 1. Equivalent Open-Loop Circuit

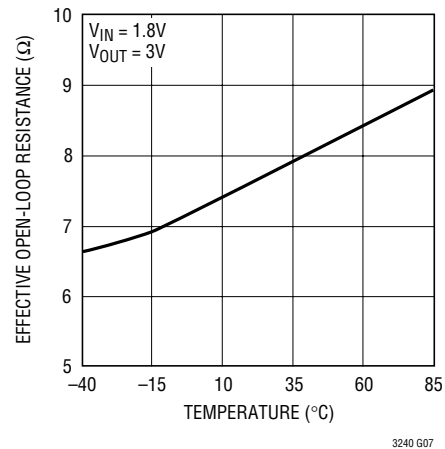

Figure 2. Typical R_{OL} vs Temperature

V_{IN} , V_{OUT} Capacitor Selection

The style and value of capacitors used with the LTC3240 determine several important parameters such as regulator control loop stability, output ripple, charge pump strength and minimum start-up time.

To reduce noise and ripple, it is recommended that low ESR ($<0.1\Omega$) ceramic capacitors be used for both C_{IN} and C_{OUT} . C_{IN} should be $1\mu F$ or greater while C_{OUT} should be $4.7\mu F$ or greater. Tantalum and aluminum capacitors are not recommended because of their high ESR.

APPLICATIONS INFORMATION

In charge pump mode the value of C_{OUT} directly controls the amount of output ripple for a given load current. Increasing the size of C_{OUT} will reduce the output ripple at the expense of higher minimum turn-on time. The peak-to-peak output ripple is approximately given by the expression:

$$V_{RIPPLE(P-P)} \cong \frac{I_{OUT}}{2f_{OSC} \cdot C_{OUT}}$$

where f_{OSC} is the oscillator frequency (typically 1.2MHz) and C_{OUT} is the value of the output capacitor.

Also, the value and style of the output capacitor can significantly affect the stability of the LTC3240. As shown in the Block Diagram, the LTC3240 uses a linear control loop to adjust the strength of the charge pump to match the current required at the output. The error signal of this loop is stored directly on the output storage capacitor. This output capacitor also serves to form the dominant pole of the control loop. To prevent ringing or instability on the LTC3240, it is important to maintain at least 2 μ F of capacitance over all conditions.

Excessive ESR on the output capacitor can degrade the loop stability of the LTC3240. The closed-loop output resistance of the LTC3240 is designed to be 0.5 Ω . For a 100mA load current change, the output voltage will change by about 50mV. If the output capacitor has 0.5 Ω or more of ESR, the closed-loop frequency response will cease to roll off in a simple one-pole fashion and poor load transient response or instability could result. Ceramic capacitors typically have exceptional ESR performance and combined with a tight board layout should yield very good stability and load transient performance.

Just as the value of C_{OUT} controls the amount of output ripple, the value of C_{IN} controls the amount of ripple present at the input pin (V_{IN}) in charge pump mode. The input current to the LTC3240 is relatively constant during the input charging phase and the output charging phase but drops to zero during the nonoverlap times. Since the nonoverlap time is small (~25ns), these missing notches result in a small perturbation on the input power supply line. A higher ESR capacitor such as tantalum will have higher input noise than a low ESR ceramic capacitor. Therefore, ceramic capacitors are again recommended for their exceptional ESR performance.

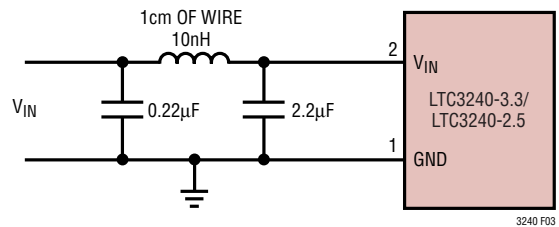

Figure 3. 10nH Inductor Used for Additional Input Noise Reduction

Further input noise reduction can be achieved by powering the LTC3240 through a very small series inductor as shown in Figure 3. A 10nH inductor will reject the fast current notches, thereby presenting a nearly constant current load to the input power supply. For economy, the 10nH inductor can be fabricated on the PC board with about 1cm (0.4") of PC board trace.

Flying Capacitor Selection

Warning: A polarized capacitor such as tantalum or aluminum should never be used for the flying capacitor since its voltage can reverse upon start-up of the LTC3240. Low ESR ceramic capacitors should always be used for the flying capacitor.

The flying capacitor controls the strength of the charge pump. A 1 μ F or greater ceramic capacitor is suggested for the flying capacitor. For the LTC3240-3.3 operating at an input voltage in the range $1.8V \leq V_{IN} \leq 2.5V$, it is necessary to have at least 0.5 μ F of capacitance for the flying capacitor in order to achieve the maximum rated current of 40mA.

For very light load applications, the flying capacitor may be reduced to save space or cost. From the first order approximation of R_{OL} in the "Effective Open-Loop Output Resistance" section, the theoretical minimum output resistance of a voltage doubling charge pump can be expressed by the following equation:

$$R_{OL(MIN)} = \frac{2V_{IN} - V_{OUT}}{I_{OUT}} \cong \frac{1}{f_{OSC} \cdot C_{FLY}}$$

where f_{OSC} is the switching frequency (1.2MHz) and C_{FLY} is the value of the flying capacitor. The charge pump will typically be weaker than the theoretical limit due

APPLICATIONS INFORMATION

to additional switch resistance. However, for very light load applications, the above expression can be used as a guideline in determining a starting capacitor value.

Ceramic Capacitors

Ceramic capacitors of different materials lose their capacitance with higher temperature and voltage at different rates. For example, a capacitor made of X5R or X7R material will retain most of its capacitance from -40°C to 85°C whereas a Z5U or Y5V style capacitor will lose considerable capacitance over that range. Z5U and Y5V capacitors may also have a poor voltage coefficient causing them to lose 60% or more of their capacitance when the rated voltage is applied. Therefore when comparing different capacitors, it is often more appropriate to compare the amount of achievable capacitance for a given case size rather than discussing the specified capacitance value. For example, a $4.7\mu\text{F}$ 10V Y5V ceramic capacitor in a 0805 case only retains 25% of its rated capacitance over temperature with a 3.3V bias, while a $4.7\mu\text{F}$ 10V X5R ceramic capacitor will retain 80% of its rated capacitance over the same conditions. The capacitor manufacturer's data sheet should be consulted to ensure the desired capacitance at all temperatures and voltages.

Below is a list of ceramic capacitor manufacturers and how to contact them:

AVX	www.avxcorp.com
Kemet	www.kemet.com
Murata	www.murata.com
Taiyo Yuden	www.t-yuden.com
Vishay	www.vishay.com
TDK	www.component.tdk.com

Layout Considerations

Due to the high switching frequency and high transient currents produced by LTC3240, careful board layout is necessary for optimum performance. A true ground plane and short connections to all the external capacitors will improve performance and ensure proper regulation under all conditions. Figure 4 shows an example layout for the LTC3240.

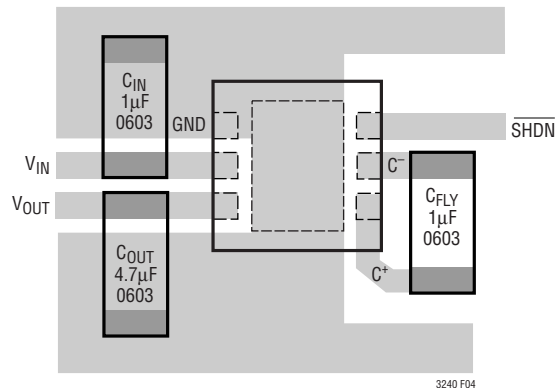

Figure 4. Recommended Layout

Thermal Management

For higher input voltages and maximum output current, there can be substantial power dissipation in the LTC3240. If the junction temperature increases above approximately 160°C , the thermal shutdown circuitry will automatically deactivate the output. To reduce the maximum junction temperature, a good thermal connection to the PC board is recommended. Connecting GND (Pin 1) and the Exposed Pad of the DFN package to a ground plane under the device on two layers of the PC board can reduce the thermal resistance of the package and PC board considerably.

Derating Power at High Temperatures

To prevent an overtemperature condition in high power applications, Figure 5 should be used to determine the maximum combination of ambient temperature and power dissipation.

The power dissipated in the LTC3240 should always fall under the line shown for a given ambient temperature. The power dissipation of the LTC3240 in step-up mode is given by the expression:

$$P_D = (2V_{IN} - V_{OUT}) \cdot I_{OUT}$$

The power dissipation in step-down mode is given by:

$$P_D = (V_{IN} - V_{OUT}) \cdot I_{OUT}$$

APPLICATIONS INFORMATION

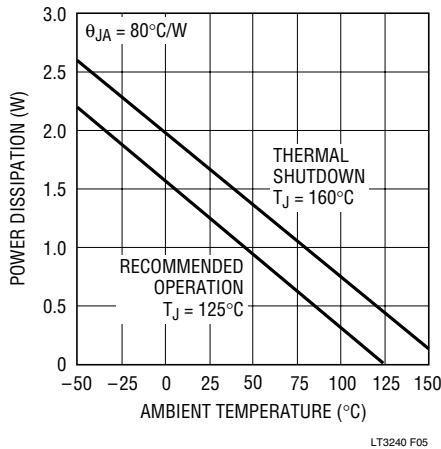

Figure 5. Maximum Power Dissipation vs Ambient Temperature

This derating curve assumes a maximum thermal resistance, θ_{JA} , of $80^{\circ}\text{C}/\text{W}$ for the 2×2 DFN package. This can be achieved from a printed circuit board layout with a solid ground plane and a good connection to the ground pins of LTC3240 and the Exposed Pad of the DFN package.

It is recommended that the LTC3240 be operated in the region corresponding to $T_J \leq 125^{\circ}\text{C}$ for continuous operation as shown in Figure 5. Short term operation may be acceptable for $125^{\circ}\text{C} \leq T_J \leq 160^{\circ}\text{C}$ but long term operation in this region should be avoided as it may reduce the life of the part or cause degraded performance. For $T_J \geq 160^{\circ}\text{C}$, the part will be in thermal shutdown.

PACKAGE DESCRIPTION

DC Package 6-Lead Plastic DFN ($2\text{mm} \times 2\text{mm}$) (Reference LTC DWG # 05-08-1703)

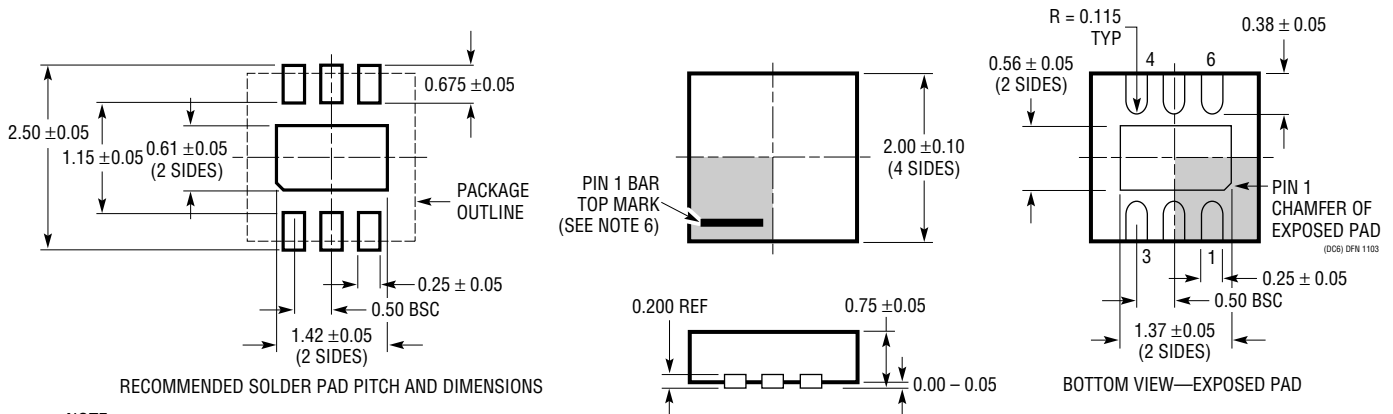

- NOTE:
1. DRAWING TO BE MADE A JEDEC PACKAGE OUTLINE M0-229 VARIATION OF (WCCD-2)
 2. DRAWING NOT TO SCALE
 3. ALL DIMENSIONS ARE IN MILLIMETERS
 4. DIMENSIONS OF EXPOSED PAD ON BOTTOM OF PACKAGE DO NOT INCLUDE MOLD FLASH. MOLD FLASH, IF PRESENT, SHALL NOT EXCEED 0.15mm ON ANY SIDE
 5. EXPOSED PAD SHALL BE SOLDER PLATED
 6. SHADED AREA IS ONLY A REFERENCE FOR PIN 1 LOCATION ON THE TOP AND BOTTOM OF PACKAGE

LTC3240-3.3/LTC3240-2.5

TYPICAL APPLICATION

2.5V Output from 2-Cell NiMH

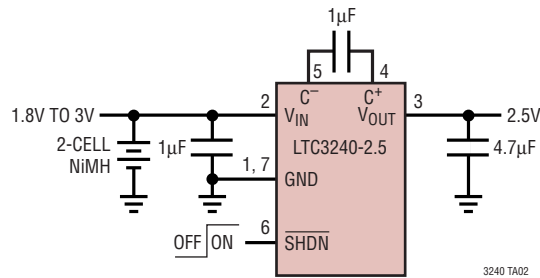

RELATED PARTS

PART NUMBER	DESCRIPTION	COMMENTS
LTC1751-3.3/LTC1751-5	100mA, 800kHz Regulated Doubler	V_{IN} : 2V to 5V, $V_{OUT(MAX)}$ = 3.3V/5V, I_Q = 20 μ A, I_{SD} < 2 μ A, MS8 Package
LTC1983-3/LTC1983-5	100mA, 900kHz Regulated Inverter	V_{IN} : 3.3V to 5.5V, $V_{OUT(MAX)}$ = -3V/-5V, I_Q = 25 μ A, I_{SD} < 2 μ A, ThinSOT™ Package
LTC3200-5	100mA, 2MHz Low Noise, Doubler/White LED Driver	V_{IN} : 2.7V to 4.5V, $V_{OUT(MAX)}$ = 5V, I_Q = 3.5mA, I_{SD} < 1 μ A, ThinSOT Package
LTC3202	125mA, 1.5MHz Low Noise, Fractional White LED Driver	V_{IN} : 2.7V to 4.5V, $V_{OUT(MAX)}$ = 5.5V, I_Q = 2.5mA, I_{SD} < 1 μ A, DFN, MS Packages
LTC3204-3.3 LTC3204B-3.3 LTC3204-5 LTC3204B-5	Low Noise, Regulated Charge Pumps in (2mm × 2mm) DFN Package	V_{IN} : 1.8V to 4.5V (LTC3204B-3.3), 2.7V to 5.5V (LTC3204B-5), I_Q = 48 μ A, "B" Version Without Burst Mode Operation, 6-Lead (2mm × 2mm) DFN Package
LTC3440	600mA (I_{OUT}) 2MHz Synchronous Buck-Boost DC/DC Converter	95% Efficiency, V_{IN} : 2.5V to 5.5V, $V_{OUT(MIN)}$ = 2.5V, I_Q = 25 μ A, I_{SD} ≤ 1 μ A, 10-Lead MS Package
LTC3441	High Current Micropower 1MHz Synchronous Buck-Boost DC/DC Converter	95% Efficiency, V_{IN} : 2.5V to 5.5V, $V_{OUT(MIN)}$ = 2.5V, I_Q = 25 μ A, I_{SD} ≤ 1 μ A, DFN Package
LTC3443	High Current Micropower 600kHz Synchronous Buck-Boost DC/DC Converter	96% Efficiency, V_{IN} : 2.4V to 5.5V, $V_{OUT(MIN)}$ = 2.4V, I_Q = 28 μ A, I_{SD} < 1 μ A, DFN Package

ThinSOT is a trademark of Linear Technology Corporation