

REMINDERS FOR USING THESE PRODUCTS

Before using these products, be sure to request the delivery specifications.

SAFETY REMINDERS

Please pay sufficient attention to the warnings for safe designing when using this products.

REMINDERS

- The storage period is less than 6 months. Be sure to follow the storage conditions (temperature: 5 to 40°C, humidity: 10 to 75% RH or less).
If the storage period elapses, the soldering of the terminal electrodes may deteriorate.
- Do not use or store in locations where there are conditions such as gas corrosion (salt, acid, alkali, etc.).
- Before soldering, be sure to preheat components.
The preheating temperature should be set so that the temperature difference between the solder temperature and chip temperature does not exceed 150°C.
- Soldering corrections after mounting should be within the range of the conditions determined in the specifications.
If overheated, a short circuit, performance deterioration, or lifespan shortening may occur.
- When embedding a printed circuit board where a chip is mounted to a set, be sure that residual stress is not given to the chip due to the overall distortion of the printed circuit board and partial distortion such as at screw tightening portions.
- Self heating (temperature increase) occurs when the power is turned ON, so the tolerance should be sufficient for the set thermal design.
- Carefully lay out the coil for the circuit board design of the non-magnetic shield type.
A malfunction may occur due to magnetic interference.
- Use a wrist band to discharge static electricity in your body through the grounding wire.
- Do not expose the products to magnets or magnetic fields.
- Do not use for a purpose outside of the contents regulated in the delivery specifications.
- The products listed on this catalog are intended for use in general electronic equipment (AV equipment, telecommunications equipment, home appliances, amusement equipment, computer equipment, personal equipment, office equipment, measurement equipment, industrial robots) under a normal operation and use condition.
The products are not designed or warranted to meet the requirements of the applications listed below, whose performance and/or quality require a more stringent level of safety or reliability, or whose failure, malfunction or trouble could cause serious damage to society, person or property.
If you intend to use the products in the applications listed below or if you have special requirements exceeding the range or conditions set forth in the each catalog, please contact us.

- (1) Aerospace/aviation equipment
- (2) Transportation equipment (cars, electric trains, ships, etc.)
- (3) Medical equipment
- (4) Power-generation control equipment
- (5) Atomic energy-related equipment
- (6) Seabed equipment
- (7) Transportation control equipment

- (8) Public information-processing equipment
- (9) Military equipment
- (10) Electric heating apparatus, burning equipment
- (11) Disaster prevention/crime prevention equipment
- (12) Safety equipment
- (13) Other applications that are not considered general-purpose applications

When designing your equipment even for general-purpose applications, you are kindly requested to take into consideration securing protection circuit/device or providing backup circuits in your equipment.

Balun transformers

Wound SMD

Product compatible with RoHS directive

Halogen-free

Compatible with lead-free solders

Overview of the ATB series

FEATURES

- Chip balun transformer developed for impedance systems; ATB2012E-20011 is for 20Ω impedance, ATB2012-50011 and ATB2012E-50011M are for 50Ω impedance and ATB2012-75011 and ATB2012E-75011M are for 75Ω impedance.
- Input impedance is 20Ω for ATB2012E-20011, 50Ω for ATB2012-50011 and ATB2012E-50011M, and 75Ω for ATB2012-75011 and ATB2012E-75011M.
- The impedance ratio is 1:1.
- The frequency band width for ATB2012E-20011 is 13.56MHz (standard IL = 0.75dB), for ATB2012-50011 is 40MHz to 860MHz (standard IL = 1.0dB), for ATB2012E-50011M is 400MHz to 1.8GHz (standard IL = 1.0dB), for ATB2012-75011 is 50MHz to 1.2GHz (standard IL = 0.8dB) and for ATB2012E-75011M is 400MHz to 1.8GHz (standard IL = 1.0dB).

APPLICATION

- TV and mobile device tuners (DVB-T/H, ISDB-T, etc.)
- STB / tuner power divider
- NFC (Near Field Communication)

PART NUMBER CONSTRUCTION

| | | | | | | | | | |
|-------------|-----------------------|---------|---------------|---------------------|----|-----------------|-----|-----------------|---------------|
| ATB | 2012 | E | - | 200 | 11 | - | T | 06 | |
| Series name | L x W dimensions (mm) | | Internal code | Input impedance (Ω) | | Impedance ratio | | Packaging style | Internal code |
| | 2012 | 2.0x1.2 | E | 200 | 20 | 11 | 1:1 | T | ø180mm reel |

| | | | | | | | | |
|-------------|-----------------------|---------|---------------------|----|-----------------|-----|-----------------|---------------|
| ATB | 2012 | - | 500 | 11 | - | T | 000 | |
| Series name | L x W dimensions (mm) | | Input impedance (Ω) | | Impedance ratio | | Packaging style | Internal code |
| | 2012 | 2.0x1.2 | 500 | 50 | 11 | 1:1 | T | ø180mm reel |
| | | | 750 | 75 | | | | |

| | | | | | | | | | | |
|-------------|-----------------------|---------|---------------|---------------------|----|-----------------|------------------|-----------------|---------------|-------------|
| ATB | 2012 | E | - | 500 | 11 | M | - | T | 01 | |
| Series name | L x W dimensions (mm) | | Internal code | Input impedance (Ω) | | Impedance ratio | Product internal | Packaging style | Internal code | |
| | 2012 | 2.0x1.2 | E | 500 | 50 | 11 | 1:1 | M | T | ø180mm reel |
| | | | | 750 | 75 | | | | | |

OPERATING TEMPERATURE RANGE, PACKAGE QUANTITY, PRODUCT WEIGHT

| Type | Temperature range | | Reel diameter | Package quantity (pieces/reel) | Individual weight (mg) |
|-----------------|-----------------------------|----------------------------|---------------|--------------------------------|------------------------|
| | Operating temperature* (°C) | Storage temperature** (°C) | | | |
| ATB2012E-20011 | -40 to +85 | -40 to +85 | ø180mm | 4000 | 5 |
| ATB2012-50011 | -40 to +85 | -40 to +85 | ø180mm | 2000 | 8 |
| ATB2012E-50011M | -40 to +85 | -40 to +85 | ø180mm | 2000 | 8 |
| ATB2012-75011 | -40 to +85 | -40 to +85 | ø180mm | 2000 | 8 |
| ATB2012E-75011M | -40 to +85 | -40 to +85 | ø180mm | 2000 | 8 |

* Operating temperature range includes self-temperature rise.

** The storage temperature range is for after the assembly.

○ RoHS Directive Compliant Product: See the following for more details. <https://product.tdk.com/info/en/environment/rohs/index.html>

○ Halogen-free: indicates that Cl content is less than 900ppm, Br content is less than 900ppm, and that the total Cl and Br content is less than 1500ppm.

⚠ Please be sure to request delivery specifications that provide further details on the features and specifications of the products for proper and safe use. Please note that the contents may change without any prior notice due to reasons such as upgrading.

Overview of the ATB series

RECOMMENDED REFLOW PROFILE

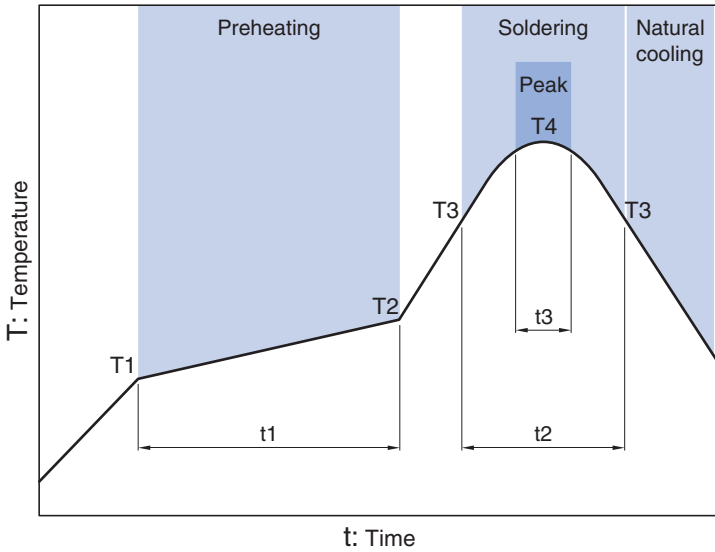

| Preheating | | | Soldering | | Peak | |
|------------|-------|------------|-----------|-----------|-------|---------|
| Temp. | Temp. | Time | Temp. | Time | Temp. | Time |
| T1 | T2 | t1 | T3 | t2 | T4 | t3 |
| 150°C | 180°C | 60 to 120s | 230°C | 10 to 30s | 245°C | 5s max. |

 Please be sure to request delivery specifications that provide further details on the features and specifications of the products for proper and safe use. Please note that the contents may change without any prior notice due to reasons such as upgrading.

ATB series

ATB2012E-20011 type

SHAPE & DIMENSIONS

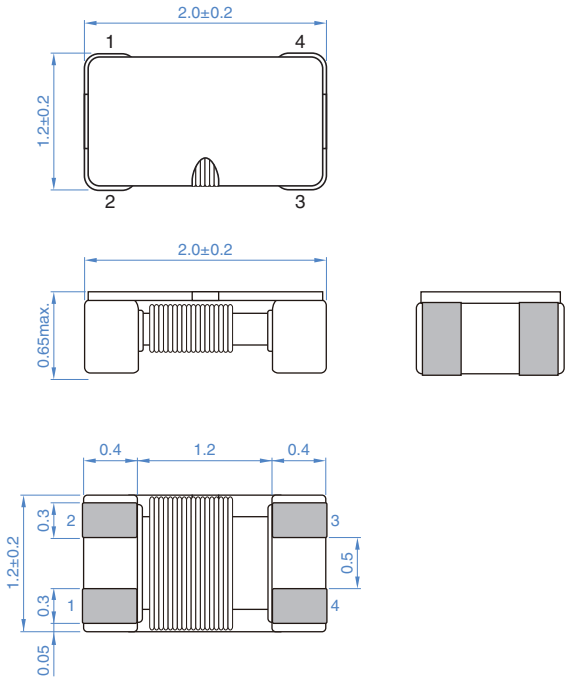

Dimensions in mm

RECOMMENDED LAND PATTERN

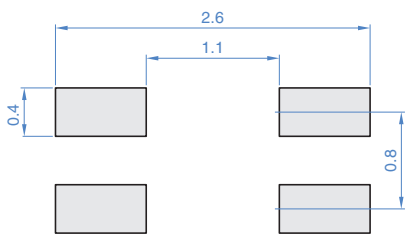

Dimensions in mm

CIRCUIT DIAGRAM

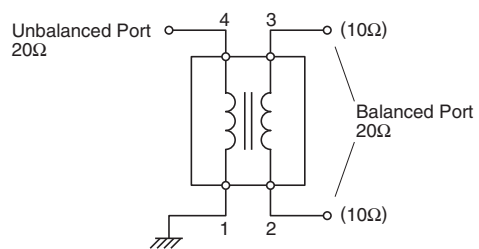

 Please be sure to request delivery specifications that provide further details on the features and specifications of the products for proper and safe use. Please note that the contents may change without any prior notice due to reasons such as upgrading.

ATB series **ATB2012E-20011 type**

■ ELECTRICAL CHARACTERISTICS

□ CHARACTERISTICS SPECIFICATION TABLE

| Frequency range (MHz) | UB/B impedance (Ω) | Insertion loss (dB)max. | CMRR typ. | DC resistance (Ω)max. | Rated current (mA) | Rated voltage (V) | Insulation resistance (MΩ)min. | Part No. |
|-----------------------|--------------------|-------------------------|-----------|-----------------------|--------------------|-------------------|--------------------------------|--------------------|
| 13.56 | 20/20 | 1.0 | 20 | 1.0 | 200 | 20 | 10 | ATB2012E-20011-T06 |

■ FREQUENCY CHARACTERISTICS

□ INSERTION LOSS

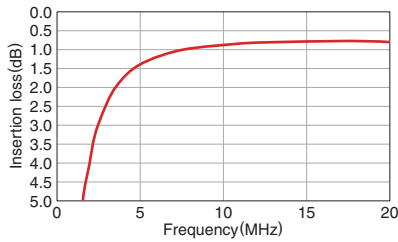

□ RETURN LOSS

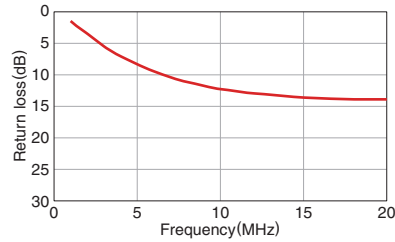

□ CMRR

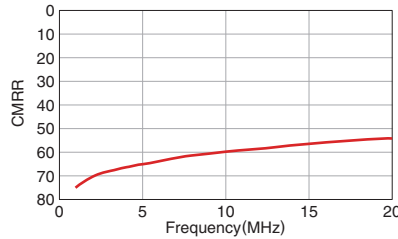

□ PHASE BALANCE

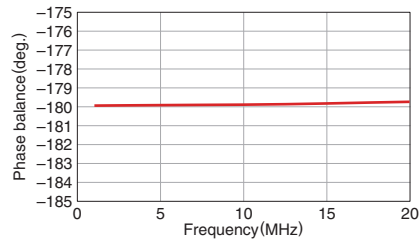

○ Measurement equipment

| Measurement item | Product No. | Manufacturer |
|-----------------------|-------------|-----------------------|
| DC resistance | 4338A | Keysight Technologies |
| Insulation resistance | 4339A | Keysight Technologies |
| Insertion loss | E5071B | Keysight Technologies |
| Return loss | E5071B | Keysight Technologies |
| Amplitude imbalance | E5071B | Keysight Technologies |
| Phase balance | E5071B | Keysight Technologies |

* Equivalent measurement equipment may be used.

 Please be sure to request delivery specifications that provide further details on the features and specifications of the products for proper and safe use. Please note that the contents may change without any prior notice due to reasons such as upgrading.

ATB series

ATB2012-50011 type

SHAPE & DIMENSIONS

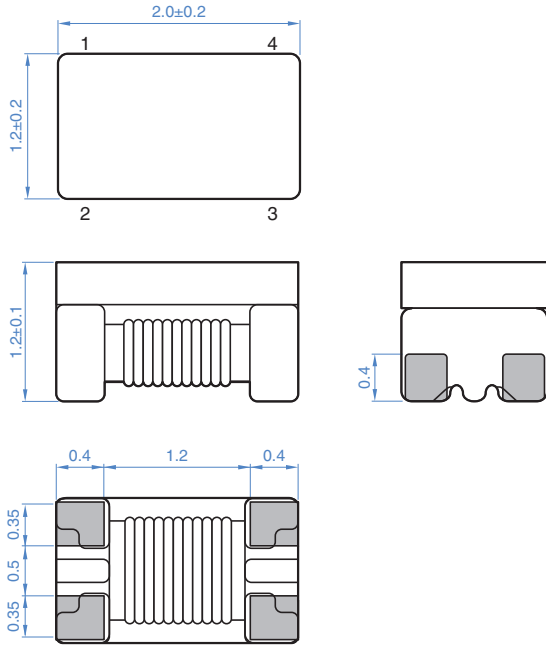

Dimensions in mm

RECOMMENDED LAND PATTERN

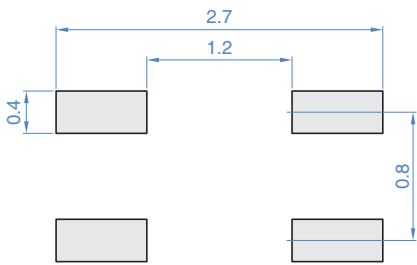

Dimensions in mm

CIRCUIT DIAGRAM

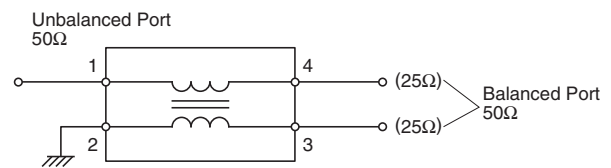

 Please be sure to request delivery specifications that provide further details on the features and specifications of the products for proper and safe use. Please note that the contents may change without any prior notice due to reasons such as upgrading.

ATB series ATB2012-50011 type

ELECTRICAL CHARACTERISTICS

CHARACTERISTICS SPECIFICATION TABLE

| Frequency range (MHz) | UB/B impedance (Ω) | Insertion loss (dB) | | CMRR typ. | DC resistance (Ω)max. | Rated current (mA) | Rated voltage (V) | Insulation resistance ($M\Omega$)min. | Withstanding voltage (V) | Part No. |
|-----------------------|-----------------------------|---------------------|------|-----------|--------------------------------|--------------------|-------------------|-----------------------------------------|--------------------------|--------------------|
| | | typ. | max. | | | | | | | |
| 40 to 860 | 50/50 | 1.0 | 2.5 | 20 | 1.0 | 200 | 20 | 10 | 125 | ATB2012-50011-T000 |

FREQUENCY CHARACTERISTICS

INSERTION LOSS

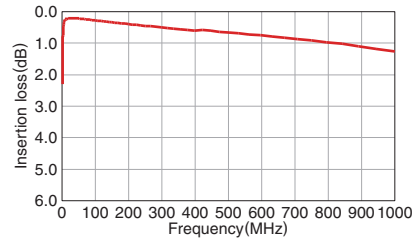

RETURN LOSS

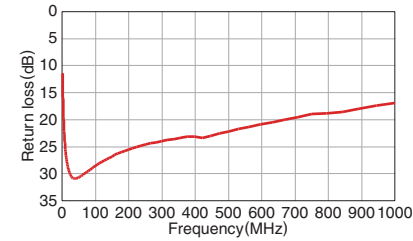

AMPLITUDE IMBALANCE

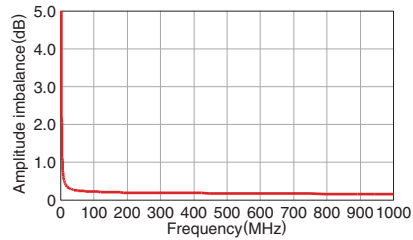

PHASE BALANCE

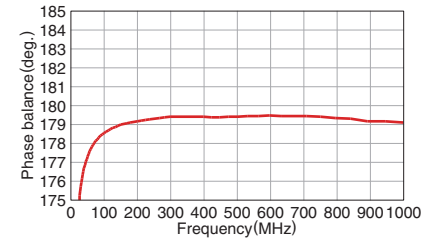

Measurement equipment

| Measurement item | Product No. | Manufacturer |
|-----------------------|-------------|-----------------------|
| DC resistance | 4338A | Keysight Technologies |
| Insulation resistance | 4339A | Keysight Technologies |
| Insertion loss | E5071B | Keysight Technologies |
| Return loss | E5071B | Keysight Technologies |
| Amplitude imbalance | E5071B | Keysight Technologies |
| Phase balance | E5071B | Keysight Technologies |

* Equivalent measurement equipment may be used.

 Please be sure to request delivery specifications that provide further details on the features and specifications of the products for proper and safe use. Please note that the contents may change without any prior notice due to reasons such as upgrading.

ATB series

ATB2012E-50011M type

SHAPE & DIMENSIONS

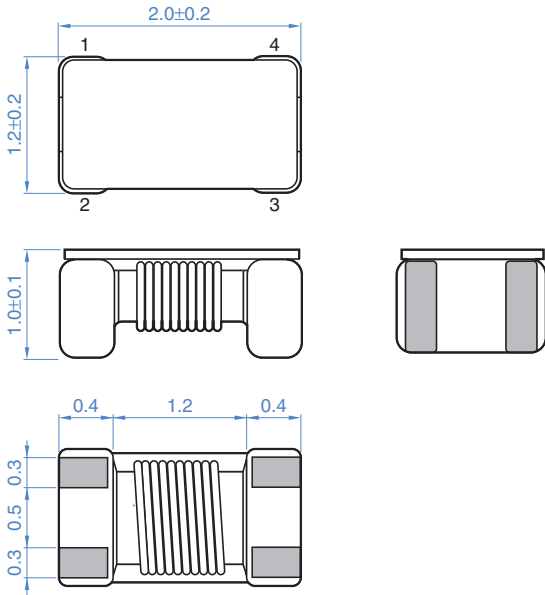

Dimensions in mm

RECOMMENDED LAND PATTERN

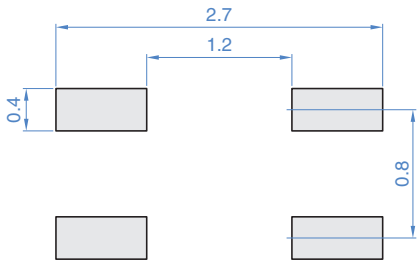

Dimensions in mm

CIRCUIT DIAGRAM

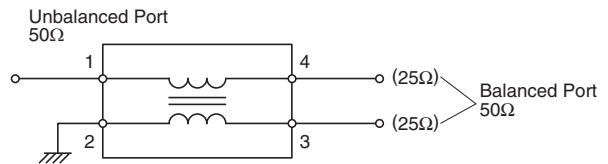

 Please be sure to request delivery specifications that provide further details on the features and specifications of the products for proper and safe use. Please note that the contents may change without any prior notice due to reasons such as upgrading.

ATB series ATB2012E-50011M type

ELECTRICAL CHARACTERISTICS

CHARACTERISTICS SPECIFICATION TABLE

| Frequency range (MHz) | UB/B impedance (Ω) | Insertion loss (dB) | | CMRR typ. | DC resistance (Ω)max. | Rated current (mA) | Rated voltage (V) | Insulation resistance ($M\Omega$)min. | Withstanding voltage (V) | Part No. |
|-----------------------|-----------------------------|---------------------|------|-----------|--------------------------------|--------------------|-------------------|-----------------------------------------|--------------------------|---------------------|
| | | typ. | max. | | | | | | | |
| 400 to 1800 | 50/50 | 1.0 | 2.2 | 15 | 0.5 | 150 | 20 | 10 | 125 | ATB2012E-50011M-T01 |

FREQUENCY CHARACTERISTICS

INSERTION LOSS

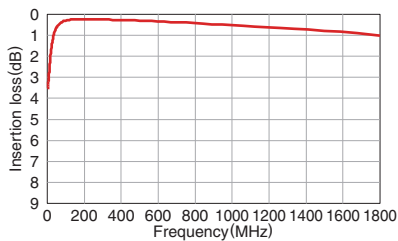

RETURN LOSS

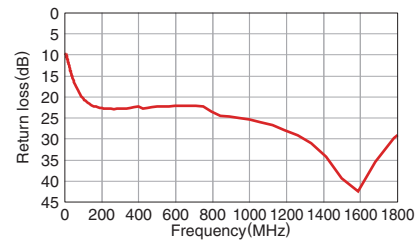

AMPLITUDE IMBALANCE

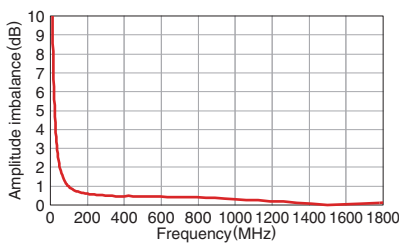

PHASE BALANCE

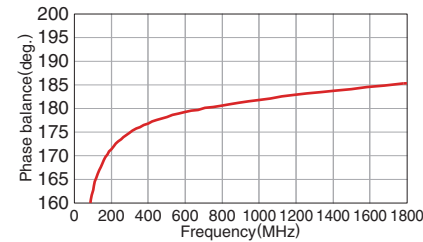

Measurement equipment

| Measurement item | Product No. | Manufacturer |
|-----------------------|-------------|-----------------------|
| DC resistance | 4338A | Keysight Technologies |
| Insulation resistance | 4339A | Keysight Technologies |
| Insertion loss | E5071B | Keysight Technologies |
| Return loss | E5071B | Keysight Technologies |
| Amplitude imbalance | E5071B | Keysight Technologies |
| Phase balance | E5071B | Keysight Technologies |

* Equivalent measurement equipment may be used.

ATB series

ATB2012-75011 type

SHAPE & DIMENSIONS

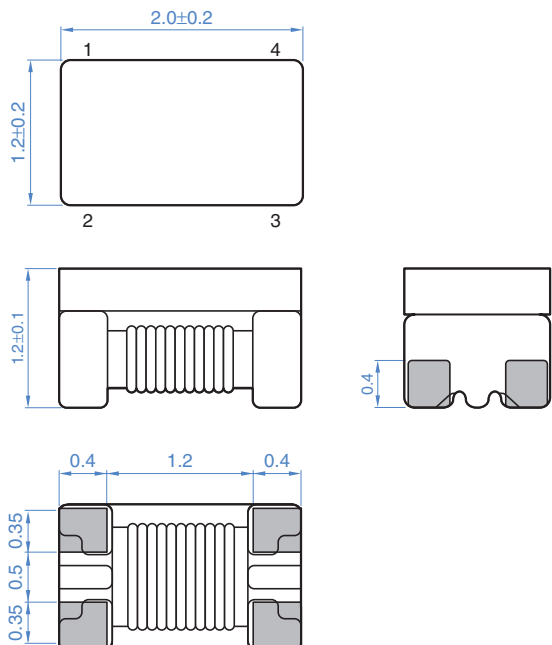

Dimensions in mm

RECOMMENDED LAND PATTERN

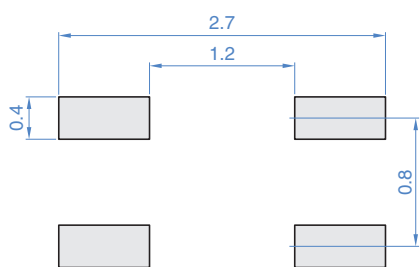

Dimensions in mm

CIRCUIT DIAGRAM

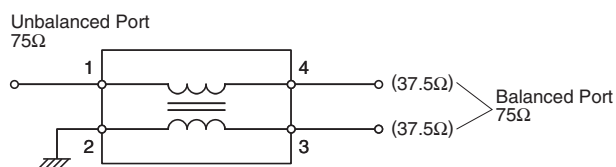

Please be sure to request delivery specifications that provide further details on the features and specifications of the products for proper and safe use. Please note that the contents may change without any prior notice due to reasons such as upgrading.

ATB series ATB2012-75011 type

ELECTRICAL CHARACTERISTICS

CHARACTERISTICS SPECIFICATION TABLE

| Frequency range (MHz) | UB/B impedance (Ω) | Insertion loss (dB) | | CMRR typ. | DC resistance (Ω)max. | Rated current (mA) | Rated voltage (V) | Insulation resistance ($M\Omega$)min. | Withstanding voltage (V) | Part No. |
|-----------------------|-----------------------------|---------------------|------|-----------|--------------------------------|--------------------|-------------------|-----------------------------------------|--------------------------|--------------------|
| | | typ. | max. | | | | | | | |
| 50 to 1200 | 75/75 | 0.8 | 1.2 | 20 | 0.7 | 280 | 20 | 10 | 125 | ATB2012-75011-T000 |

FREQUENCY CHARACTERISTICS

INSERTION LOSS

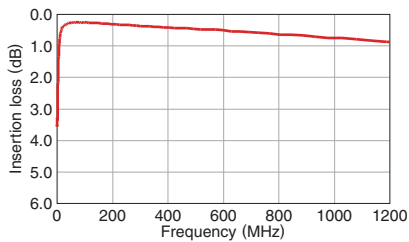

RETURN LOSS

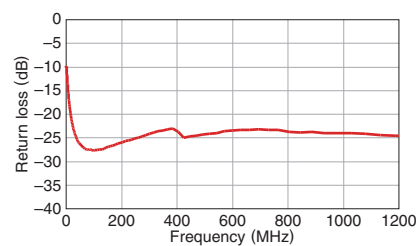

AMPLITUDE IMBALANCE

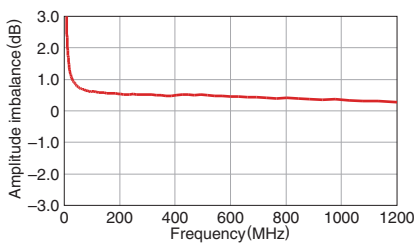

PHASE BALANCE

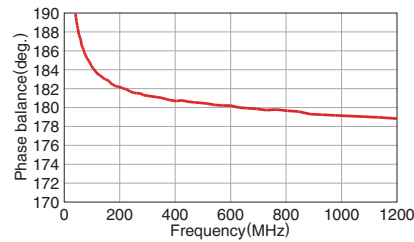

Measurement equipment

| Measurement item | Product No. | Manufacturer |
|-----------------------|-------------|-----------------------|
| DC resistance | 4338A | Keysight Technologies |
| Insulation resistance | 4339A | Keysight Technologies |
| Insertion loss | E5071B | Keysight Technologies |
| Return loss | E5071B | Keysight Technologies |
| Amplitude imbalance | E5071B | Keysight Technologies |
| Phase balance | E5071B | Keysight Technologies |

* Equivalent measurement equipment may be used.

ATB series

ATB2012E-75011M type

SHAPE & DIMENSIONS

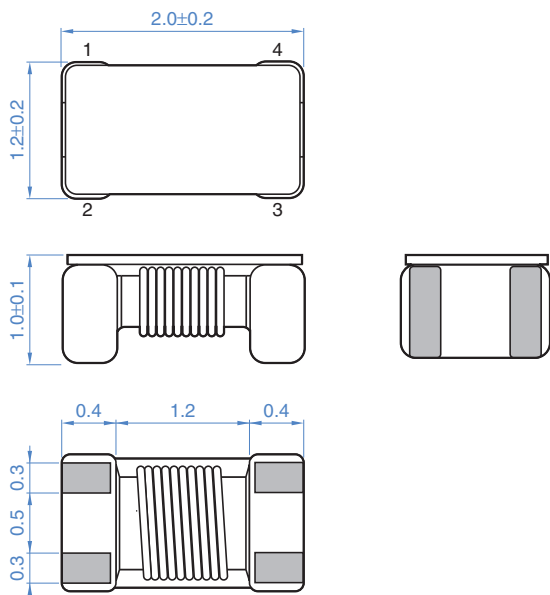

Dimensions in mm

RECOMMENDED LAND PATTERN

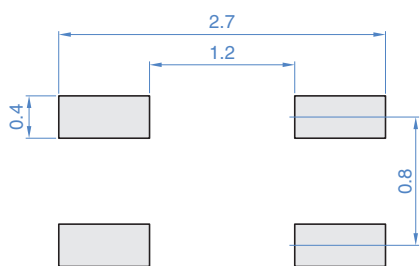

Dimensions in mm

CIRCUIT DIAGRAM

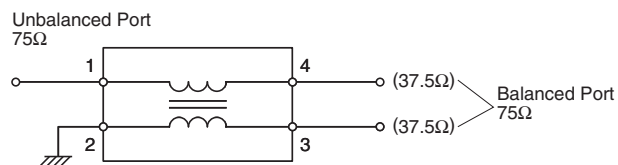

⚠ Please be sure to request delivery specifications that provide further details on the features and specifications of the products for proper and safe use. Please note that the contents may change without any prior notice due to reasons such as upgrading.

ATB series ATB2012E-75011M type

ELECTRICAL CHARACTERISTICS

CHARACTERISTICS SPECIFICATION TABLE

| Frequency range (MHz) | UB/B impedance (Ω) | Insertion loss (dB) | | CMRR typ. | DC resistance (Ω)max. | Rated current (mA) | Rated voltage (V) | Insulation resistance ($M\Omega$)min. | Withstanding voltage (V) | Part No. |
|-----------------------|-----------------------------|---------------------|------|-----------|--------------------------------|--------------------|-------------------|-----------------------------------------|--------------------------|---------------------|
| | | typ. | max. | | | | | | | |
| 400 to 1800 | 75/75 | 1.0 | 2 | 15 | 0.5 | 150 | 20 | 10 | 125 | ATB2012E-75011M-T01 |

FREQUENCY CHARACTERISTICS

INSERTION LOSS

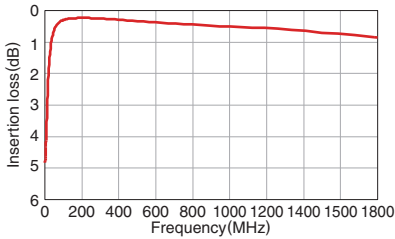

RETURN LOSS

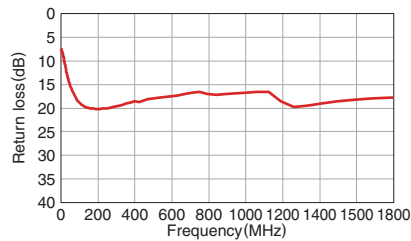

AMPLITUDE IMBALANCE

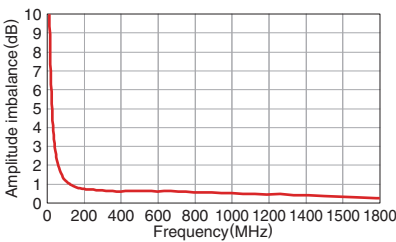

PHASE BALANCE

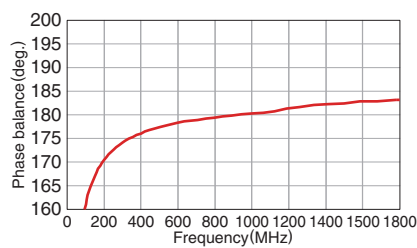

Measurement equipment

| Measurement item | Product No. | Manufacturer |
|-----------------------|-------------|-----------------------|
| DC resistance | 4338A | Keysight Technologies |
| Insulation resistance | 4339A | Keysight Technologies |
| Insertion loss | E5071B | Keysight Technologies |
| Return loss | E5071B | Keysight Technologies |
| Amplitude imbalance | E5071B | Keysight Technologies |
| Phase balance | E5071B | Keysight Technologies |

* Equivalent measurement equipment may be used.

 Please be sure to request delivery specifications that provide further details on the features and specifications of the products for proper and safe use. Please note that the contents may change without any prior notice due to reasons such as upgrading.

ATB series

Packaging style

REEL DIMENSIONS

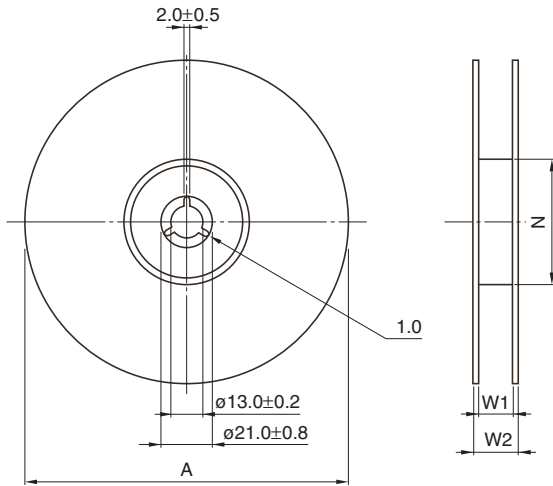

Dimensions in mm

| Type | A | W1 | W2 | N |
|-----------------|------|----|----|---|
| ATB2012E-20011 | ø180 | 13 | 60 | 9 |
| ATB2012-50011 | ø180 | 13 | 60 | 9 |
| ATB2012E-50011M | ø180 | 13 | 60 | 9 |
| ATB2012-75011 | ø180 | 13 | 60 | 9 |
| ATB2012E-75011M | ø180 | 13 | 60 | 9 |

TAPE DIMENSIONS

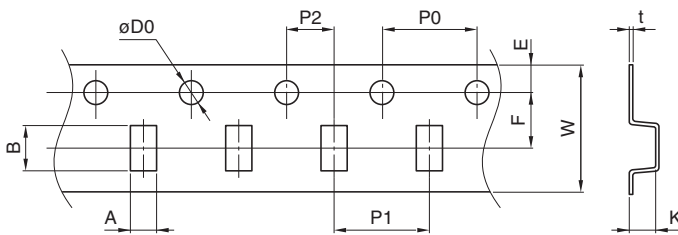

Dimensions in mm

| Type | A | B | øD0 | E | F | P0 | P1 | P2 | W | K | t |
|-----------------|----------|----------|-----------|----------|-----------|---------|---------|----------|----------|-----------|-----------|
| ATB2012E-20011 | 1.45±0.1 | 2.25±0.1 | 1.55±0.05 | 1.75±0.1 | 3.50±0.05 | 4.0±0.1 | 4.0±0.1 | 2.0±0.05 | 8.0±0.20 | 0.75±0.05 | 0.25±0.05 |
| ATB2012-50011 | 1.4±0.1 | 2.3±0.1 | 1.5±0.1/0 | 1.75±0.1 | 3.5±0.1 | 4.0±0.1 | 4.0±0.1 | 2.0±0.1 | 8.0±0.1 | 1.4±0.1 | 0.25±0.05 |
| ATB2012E-50011M | 1.4±0.1 | 2.3±0.1 | 1.5±0.1/0 | 1.75±0.1 | 3.5±0.1 | 4.0±0.1 | 4.0±0.1 | 2.0±0.1 | 8.0±0.1 | 1.15±0.1 | 0.2±0.05 |
| ATB2012-75011 | 1.4±0.1 | 2.3±0.1 | 1.5±0.1/0 | 1.75±0.1 | 3.5±0.1 | 4.0±0.1 | 4.0±0.1 | 2.0±0.1 | 8.0±0.1 | 1.4±0.1 | 0.25±0.05 |
| ATB2012E-75011M | 1.4±0.1 | 2.3±0.1 | 1.5±0.1/0 | 1.75±0.1 | 3.5±0.1 | 4.0±0.1 | 4.0±0.1 | 2.0±0.1 | 8.0±0.1 | 1.15±0.1 | 0.2±0.05 |

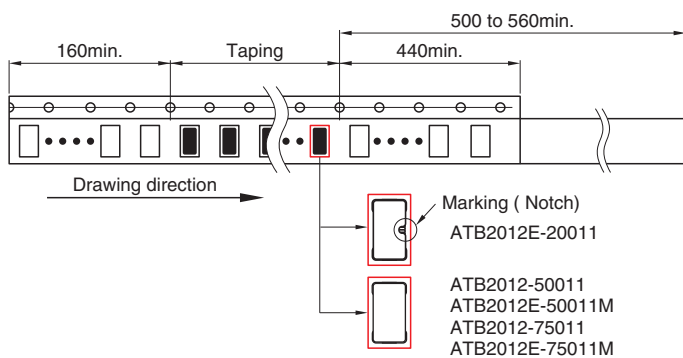

Dimensions in mm

⚠ Please be sure to request delivery specifications that provide further details on the features and specifications of the products for proper and safe use.
Please note that the contents may change without any prior notice due to reasons such as upgrading.