

TABLE OF CONTENTS

| | | | |
|--|---|---|----|
| Features | 1 | Absolute Maximum Ratings | 6 |
| Applications..... | 1 | Thermal Resistance..... | 6 |
| Pin Configuration..... | 1 | ESD Caution..... | 6 |
| General Description | 1 | Typical Performance Characteristics | 7 |
| Revision History | 2 | Terminology | 10 |
| Specifications..... | 3 | Theory of Operation | 11 |
| ADR5040 Electrical Characteristics | 3 | Applications Information..... | 11 |
| ADR5041 Electrical Characteristics | 3 | Outline Dimensions | 13 |
| ADR5043 Electrical Characteristics | 4 | Ordering Guide | 14 |
| ADR5044 Electrical Characteristics | 4 | Automotive Products..... | 14 |
| ADR5045 Electrical Characteristics | 5 | | |

REVISION HISTORY

4/2020—Rev. D to Rev. E

| | |
|---|----|
| Changes to General Description and Figure 1 | 1 |
| Added Automotive Products Section | 14 |
| Updated to Outline Dimensions | 14 |
| Changes to Ordering Guide | 14 |

5/2018—Rev. C to Rev. D

| | |
|-------------------------------------|----|
| Changes to Terminology Section..... | 10 |
| Changes to Ordering Guide | 14 |

3/2016—Rev. B to Rev. C

| | |
|---|----|
| Change to Figure 7 | 7 |
| Changed Stacking the ADR504x for User-Definable Outputs Section to Stacking the ADR5040/ADR5041/ADR5043/ ADR5044/ADR5045 for User-Definable Outputs Section | 11 |
| Changes to Figure 23..... | 12 |

8/2012—Rev. A to Rev. B

| | |
|---|----|
| Changes to Features Section and General Description Section | 1 |
| Updated Outline Dimensions..... | 13 |
| Moved Ordering Guide | 14 |
| Changes to Ordering Guide..... | 14 |
| Added Automotive Products Section | 15 |

12/2007—Rev. 0 to Rev. A

| | |
|---|----|
| Changes to Features | 1 |
| Changes to Initial Accuracy and Temperature Coefficient Parameters in Table 2 Through Table 6..... | 3 |
| Updated Outline Dimensions..... | 13 |
| Changes to Ordering Guide | 13 |

1/2007—Revision 0: Initial Version

SPECIFICATIONS

ADR5040 ELECTRICAL CHARACTERISTICS

$I_{IN} = 50 \mu\text{A}$ to 15 mA, $T_A = 25^\circ\text{C}$, unless otherwise noted.

Table 2.

| Parameter | Symbol | Test Conditions/Comments | Min | Typ | Max | Unit | | | | | |
|--------------------------------------|-----------------------------|---|--|-------|-----------|-----------------------|-------------------|--|--|-----------|----|
| OUTPUT VOLTAGE | V_{OUT} | $I_{IN} = 100 \mu\text{A}$ | 2.044 | 2.048 | 2.052 | V | | | | | |
| Grade A | | | | | | | | | | | |
| Grade B | | | 2.046 | 2.048 | 2.050 | V | | | | | |
| INITIAL ACCURACY | V_{OERR} | $I_{IN} = 100 \mu\text{A}$ | -4.096 | | +4.096 | mV | | | | | |
| Grade A | | | | | | | | | | ± 0.2 | % |
| Grade B | | | | | | | -2.048 | | | +2.048 | mV |
| | | | | | ± 0.1 | % | | | | | |
| TEMPERATURE COEFFICIENT ¹ | TCV_{OUT} | $-40^\circ\text{C} < T_A < +125^\circ\text{C}$ | | 10 | 100 | ppm/ $^\circ\text{C}$ | | | | | |
| Grade A | | | | | | | | | | | |
| Grade B | | | | 10 | 75 | ppm/ $^\circ\text{C}$ | | | | | |
| OUTPUT VOLTAGE CHANGE vs. I_{IN} | ΔV_R | $I_{IN} = 50 \mu\text{A}$ to 1 mA $-40^\circ\text{C} < T_A < +125^\circ\text{C}$ | | 0.4 | 1.75 | mV | | | | | |
| | | | | | | | | | | | |
| | | $I_{IN} = 1 \text{ mA}$ to 15 mA $-40^\circ\text{C} < T_A < +125^\circ\text{C}$ | | 4 | 8 | mV | | | | | |
| DYNAMIC OUTPUT IMPEDANCE | $(\Delta V_R / \Delta I_R)$ | $I_{IN} = 50 \mu\text{A}$ to 15 mA | | | 0.2 | Ω | | | | | |
| MINIMUM OPERATING CURRENT | I_{IN} | $T_A = 25^\circ\text{C}$ $-40^\circ\text{C} < T_A < +125^\circ\text{C}$ | | | 50 | μA | | | | | |
| | | | | | 60 | μA | | | | | |
| VOLTAGE NOISE | e_N | $I_{IN} = 100 \mu\text{A}$; 0.1 Hz to 10 Hz | | 2.8 | | $\mu\text{V rms}$ | | | | | |
| | | | $I_{IN} = 100 \mu\text{A}$; 10 Hz to 10 kHz | | 120 | | $\mu\text{V rms}$ | | | | |
| TURN-ON SETTLING TIME | t_R | $C_{LOAD} = 0 \mu\text{F}$ | | 28 | | μs | | | | | |
| OUTPUT VOLTAGE HYSTERESIS | ΔV_{OUT_HYS} | $I_{IN} = 1 \text{ mA}$ | | 40 | | ppm | | | | | |

¹ Guaranteed by design.

ADR5041 ELECTRICAL CHARACTERISTICS

$I_{IN} = 50 \mu\text{A}$ to 15 mA, $T_A = 25^\circ\text{C}$, unless otherwise noted.

Table 3.

| Parameter | Symbol | Test Conditions/Comments | Min | Typ | Max | Unit | | | | | |
|--------------------------------------|--------------|---|--------|-------|-----------|-----------------------|------|--|--|-----------|----|
| OUTPUT VOLTAGE | V_{OUT} | $I_{IN} = 100 \mu\text{A}$ | 2.495 | 2.500 | 2.505 | V | | | | | |
| Grade A | | | | | | | | | | | |
| Grade B | | | 2.4975 | 2.500 | 2.5025 | V | | | | | |
| INITIAL ACCURACY | V_{OERR} | $I_{IN} = 100 \mu\text{A}$ | -5 | | +5 | mV | | | | | |
| Grade A | | | | | | | | | | ± 0.2 | % |
| Grade B | | | | | | | -2.5 | | | +2.5 | mV |
| | | | | | ± 0.1 | % | | | | | |
| TEMPERATURE COEFFICIENT ¹ | TCV_{OUT} | $-40^\circ\text{C} < T_A < +125^\circ\text{C}$ | | 10 | 100 | ppm/ $^\circ\text{C}$ | | | | | |
| Grade A | | | | | | | | | | | |
| Grade B | | | | 10 | 75 | ppm/ $^\circ\text{C}$ | | | | | |
| OUTPUT VOLTAGE CHANGE vs. I_{IN} | ΔV_R | $I_{IN} = 50 \mu\text{A}$ to 1 mA $-40^\circ\text{C} < T_A < +125^\circ\text{C}$ | | 0.5 | 1.8 | mV | | | | | |
| | | | | | | | | | | | |
| | | $I_{IN} = 1 \text{ mA}$ to 15 mA $-40^\circ\text{C} < T_A < +125^\circ\text{C}$ | | 4 | 8 | mV | | | | | |

| Parameter | Symbol | Test Conditions/Comments | Min | Typ | Max | Unit |
|---------------------------|---------------------------|--|-----|------------|----------|----------------------------|
| DYNAMIC OUTPUT IMPEDANCE | $(\Delta V_R/\Delta I_R)$ | $I_{IN} = 50 \mu A$ to 15 mA | | | 0.2 | Ω |
| MINIMUM OPERATING CURRENT | I_{IN} | $T_A = 25^\circ C$ $-40^\circ C < T_A < +125^\circ C$ | | | 50 60 | μA μA |
| VOLTAGE NOISE | e_N | $I_{IN} = 100 \mu A$; 0.1 Hz to 10 Hz $I_{IN} = 100 \mu A$; 10 Hz to 10 kHz | | 3.2 150 | | μV rms μV rms |
| TURN-ON SETTLING TIME | t_R | $C_{LOAD} = 0 \mu F$ | | 35 | | μs |
| OUTPUT VOLTAGE HYSTERESIS | ΔV_{OUT_HYS} | $I_{IN} = 1$ mA | | 40 | | ppm |

¹ Guaranteed by design.

ADR5043 ELECTRICAL CHARACTERISTICS

$I_{IN} = 50 \mu A$ to 15 mA, $T_A = 25^\circ C$, unless otherwise noted.

Table 4.

| Parameter | Symbol | Test Conditions/Comments | Min | Typ | Max | Unit |
|--------------------------------------|---------------------------|---|-------|------------|------------------------|----------------------------|
| OUTPUT VOLTAGE | V_{OUT} | $I_{IN} = 100 \mu A$ | | | | |
| Grade A | | | 2.994 | 3.000 | 3.006 | V |
| Grade B | | | 2.997 | 3.000 | 3.003 | V |
| INITIAL ACCURACY | V_{OERR} | $I_{IN} = 100 \mu A$ | | | | |
| Grade A | | | -6 | | +6 | mV |
| Grade B | | | -3 | | +3 | mV |
| | | | | | ± 0.2 ± 0.1 | % % |
| TEMPERATURE COEFFICIENT ¹ | TCV_{OUT} | $-40^\circ C < T_A < +125^\circ C$ | | | | |
| Grade A | | | | 10 | 100 | ppm/ $^\circ C$ |
| Grade B | | | | 10 | 75 | ppm/ $^\circ C$ |
| OUTPUT VOLTAGE CHANGE vs. I_{IN} | ΔV_R | $I_{IN} = 50 \mu A$ to 1 mA $-40^\circ C < T_A < +125^\circ C$ $I_{IN} = 1$ mA to 15 mA $-40^\circ C < T_A < +125^\circ C$ | | | | |
| | | | | 0.7 | 2.2 | mV |
| | | | | 4 | 8 | mV |
| DYNAMIC OUTPUT IMPEDANCE | $(\Delta V_R/\Delta I_R)$ | $I_{IN} = 50 \mu A$ to 15 mA | | | 0.2 | Ω |
| MINIMUM OPERATING CURRENT | I_{IN} | $T_A = 25^\circ C$ $-40^\circ C < T_A < +125^\circ C$ | | | 50 60 | μA μA |
| VOLTAGE NOISE | e_N | $I_{IN} = 100 \mu A$; 0.1 Hz to 10 Hz $I_{IN} = 100 \mu A$; 10 Hz to 10 kHz | | 4.3 180 | | μV rms μV rms |
| TURN-ON SETTLING TIME | t_R | $C_{LOAD} = 0 \mu F$ | | 42 | | μs |
| OUTPUT VOLTAGE HYSTERESIS | ΔV_{OUT_HYS} | $I_{IN} = 1$ mA | | 40 | | ppm |

¹ Guaranteed by design.

ADR5044 ELECTRICAL CHARACTERISTICS

$I_{IN} = 50 \mu A$ to 15 mA, $T_A = 25^\circ C$, unless otherwise noted.

Table 5.

| Parameter | Symbol | Test Conditions/Comments | Min | Typ | Max | Unit |
|------------------|------------|--------------------------|--------|-------|-----------|------|
| OUTPUT VOLTAGE | V_{OUT} | $I_{IN} = 100 \mu A$ | | | | |
| Grade A | | | 4.088 | 4.096 | 4.104 | V |
| Grade B | | | 4.092 | 4.096 | 4.100 | V |
| INITIAL ACCURACY | V_{OERR} | $I_{IN} = 100 \mu A$ | | | | |
| Grade A | | | -8.192 | | +8.192 | mV |
| | | | | | ± 0.2 | % |

| Parameter | Symbol | Test Conditions/Comments | Min | Typ | Max | Unit |
|---|-------------------------------------|--|--------|------------|----------------|------------------|
| Grade B | | | -4.096 | | +4.096 ±0.1 | mV % |
| TEMPERATURE COEFFICIENT ¹ | TCV _{OUT} | -40°C < T _A < +125°C | | | | |
| Grade A | | | | 10 | 100 | ppm/°C |
| Grade B | | | | 10 | 75 | ppm/°C |
| OUTPUT VOLTAGE CHANGE vs. I _{IN} | ΔV _R | I _{IN} = 50 μA to 1 mA -40°C < T _A < +125°C | | 0.7 | 3 | mV |
| | | I _{IN} = 1 mA to 15 mA -40°C < T _A < +125°C | | 4 | 8 | mV |
| DYNAMIC OUTPUT IMPEDANCE | (ΔV _R /ΔI _R) | I _{IN} = 50 μA to 15 mA | | | 0.2 | Ω |
| MINIMUM OPERATING CURRENT | I _{IN} | T _A = 25°C -40°C < T _A < +125°C | | | 50 60 | μA μA |
| VOLTAGE NOISE | e _N | I _{IN} = 100 μA; 0.1 Hz to 10 Hz I _{IN} = 100 μA; 10 Hz to 10 kHz | | 5.4 240 | | μV rms μV rms |
| TURN-ON SETTLING TIME | t _R | C _{LOAD} = 0 μF | | 56 | | μs |
| OUTPUT VOLTAGE HYSTERESIS | ΔV _{OUT_HYS} | I _{IN} = 1 mA | | 40 | | ppm |

¹ Guaranteed by design.

ADR5045 ELECTRICAL CHARACTERISTICS

I_{IN} = 50 μA to 15 mA, T_A = 25°C, unless otherwise noted.

Table 6.

| Parameter | Symbol | Test Conditions/Comments | Min | Typ | Max | Unit |
|---|-------------------------------------|--|-------|------------|-------------|------------------|
| OUTPUT VOLTAGE | V _{OUT} | I _{IN} = 100 μA | | | | |
| Grade A | | | 4.990 | 5.000 | 5.010 | V |
| Grade B | | | 4.995 | 5.000 | 5.005 | V |
| INITIAL ACCURACY | V _{OERR} | I _{IN} = 100 μA | | | | |
| Grade A | | | -10 | | +10 ±0.2 | mV % |
| Grade B | | | -5 | | +5 ±0.1 | mV % |
| TEMPERATURE COEFFICIENT ¹ | TCV _{OUT} | -40°C < T _A < +125°C | | | | |
| Grade A | | | | 10 | 100 | ppm/°C |
| Grade B | | | | 10 | 75 | ppm/°C |
| OUTPUT VOLTAGE CHANGE vs. I _{IN} | ΔV _R | I _{IN} = 50 μA to 1 mA -40°C < T _A < +125°C | | 0.8 | 4 | mV |
| | | I _{IN} = 1 mA to 15 mA -40°C < T _A < +125°C | | 4 | 8 | mV |
| DYNAMIC OUTPUT IMPEDANCE | (ΔV _R /ΔI _R) | I _{IN} = 50 μA to 15 mA | | | 0.2 | Ω |
| MINIMUM OPERATING CURRENT | I _{IN} | T _A = 25°C -40°C < T _A < +125°C | | | 50 60 | μA μA |
| VOLTAGE NOISE | e _N | I _{IN} = 100 μA; 0.1 Hz to 10 Hz I _{IN} = 100 μA; 10 Hz to 10 kHz | | 6.6 280 | | μV rms μV rms |
| TURN-ON SETTLING TIME | t _R | C _{LOAD} = 0 μF | | 70 | | μs |
| OUTPUT VOLTAGE HYSTERESIS | ΔV _{OUT_HYS} | I _{IN} = 1 mA | | 40 | | ppm |

¹ Guaranteed by design.

ABSOLUTE MAXIMUM RATINGS

Ratings apply at 25°C, unless otherwise noted.

Table 7.

| Parameter | Rating |
|--------------------------------------|-----------------|
| Reverse Current | 25 mA |
| Forward Current | 20 mA |
| Storage Temperature Range | –65°C to +150°C |
| Extended Temperature Range | –40°C to +125°C |
| Junction Temperature Range | –65°C to +150°C |
| Lead Temperature (Soldering, 60 sec) | 300°C |

Stresses at or above those listed under Absolute Maximum Ratings may cause permanent damage to the product. This is a stress rating only; functional operation of the product at these or any other conditions above those indicated in the operational section of this specification is not implied. Operation beyond the maximum operating conditions for extended periods may affect product reliability.

THERMAL RESISTANCE

θ_{JA} is specified for the worst-case conditions, that is, a device soldered in a circuit board for surface-mount packages.

Table 8. Thermal Resistance

| Package Type | θ_{JA} | θ_{JC} | Unit |
|--------------|---------------|---------------|------|
| KS-3 | 580.5 | 177.4 | °C/W |
| RT-3 | 270 | 102 | °C/W |

ESD CAUTION



ESD (electrostatic discharge) sensitive device. Charged devices and circuit boards can discharge without detection. Although this product features patented or proprietary protection circuitry, damage may occur on devices subjected to high energy ESD. Therefore, proper ESD precautions should be taken to avoid performance degradation or loss of functionality.

TYPICAL PERFORMANCE CHARACTERISTICS

$T_A = 25^\circ\text{C}$, $I_{IN} = 100 \mu\text{A}$, unless otherwise noted.

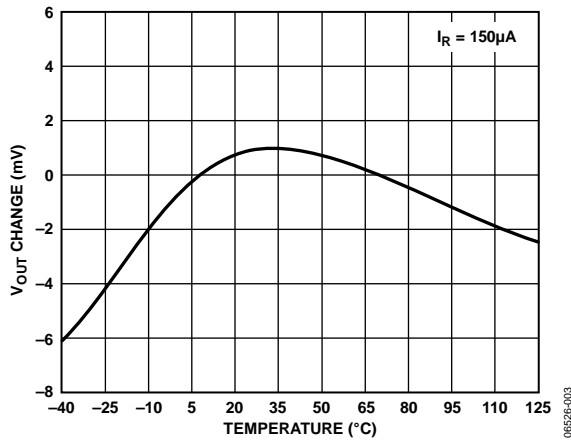

Figure 2. ADR5041 V_{OUT} Change vs. Temperature

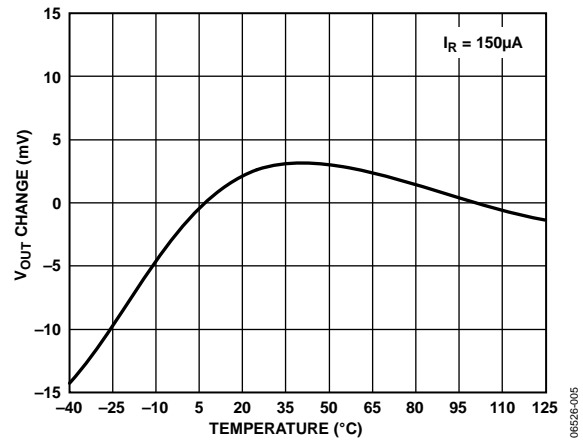

Figure 5. ADR5045 V_{OUT} Change vs. Temperature

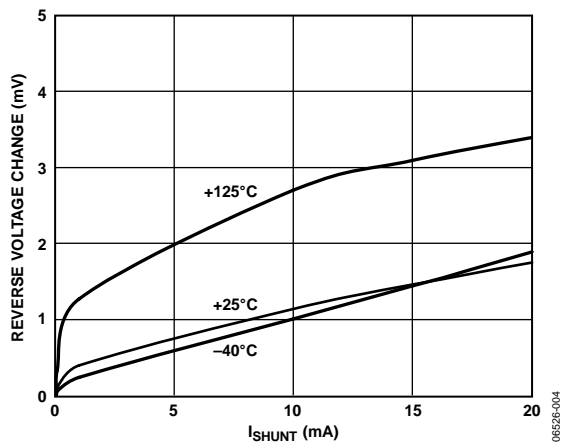

Figure 3. ADR5041 Reverse Voltage Change vs. I_{SHUNT}

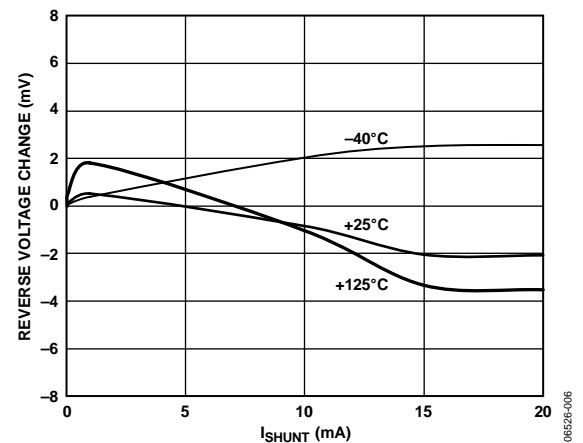

Figure 6. ADR5045 Reverse Voltage Change vs. I_{SHUNT}

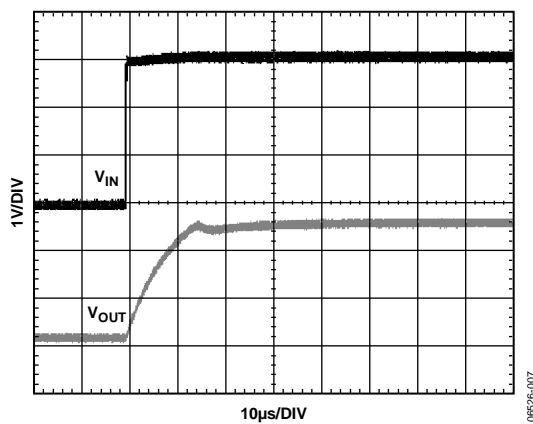

Figure 4. ADR5041 Start-Up Characteristics

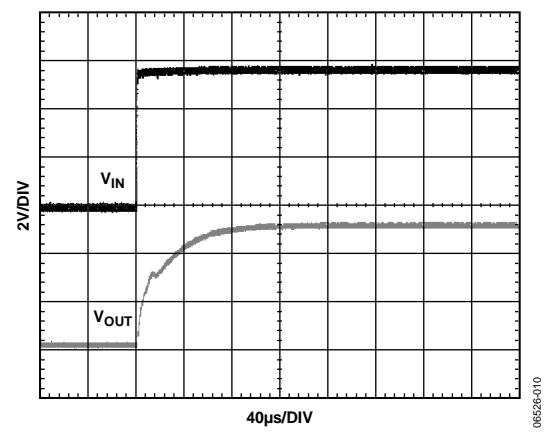

Figure 7. ADR5045 Start-Up Characteristics

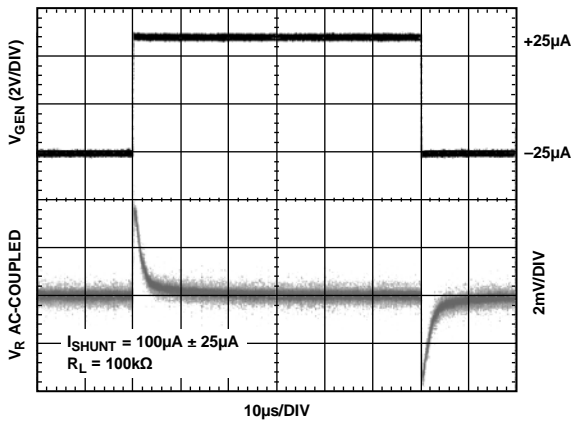

Figure 8. ADR5041 Load Transient Response

06526-008

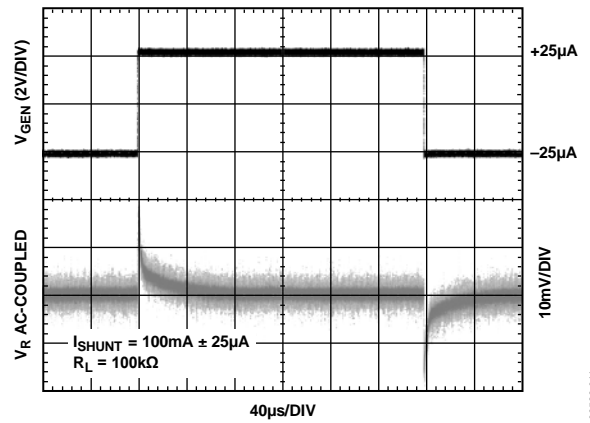

Figure 11. ADR5045 Load Transient Response

06526-011

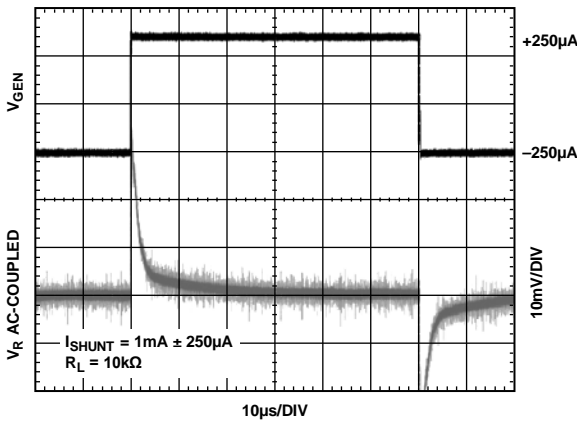

Figure 9. ADR5041 Transient Response

06526-009

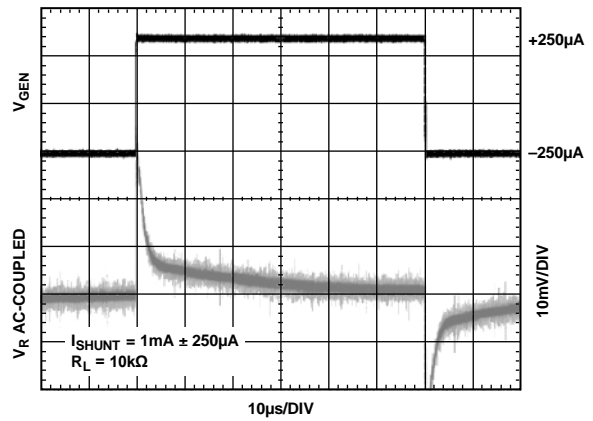

Figure 12. ADR5045 Transient Response

06526-012

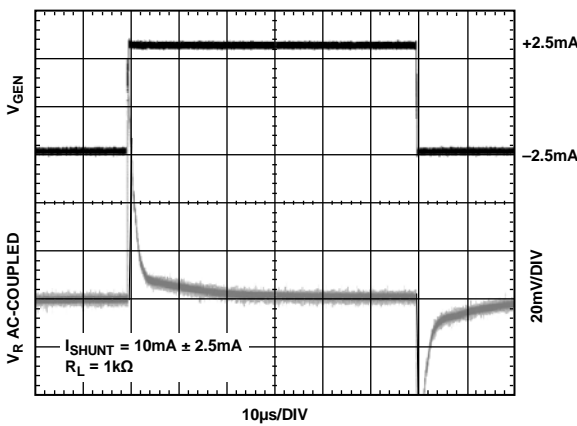

Figure 10. ADR5041 Transient Response

06526-013

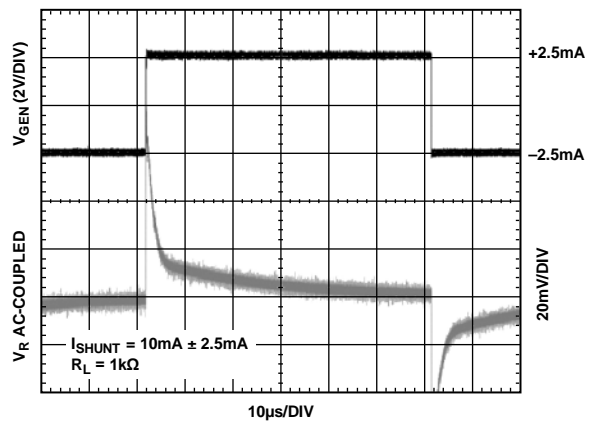

Figure 13. ADR5045 Transient Response

06526-016

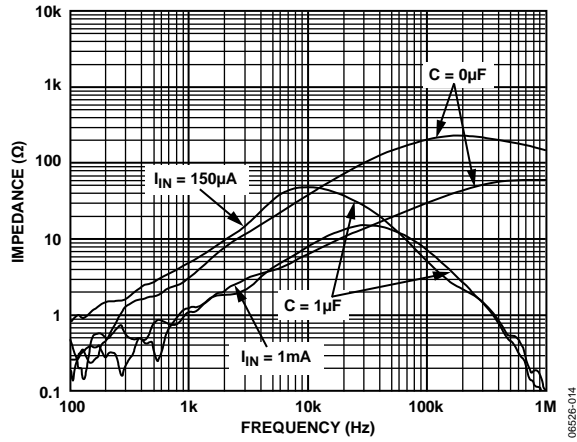

Figure 14. ADR5041 Output Impedance vs. Frequency

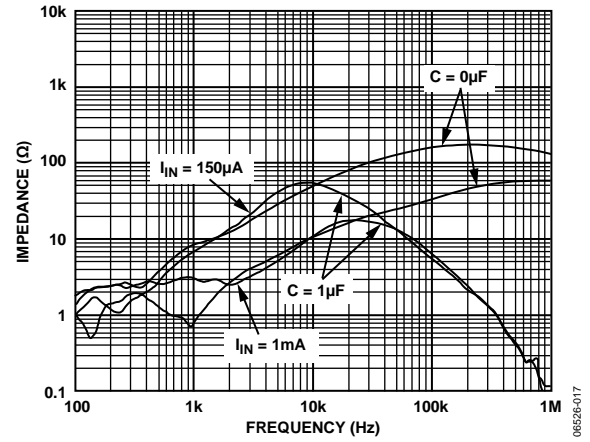

Figure 17. ADR5045 Output Impedance vs. Frequency

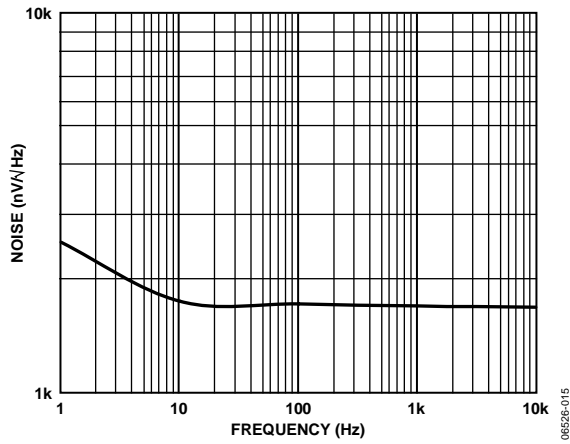

Figure 15. ADR5041 Voltage Noise Density

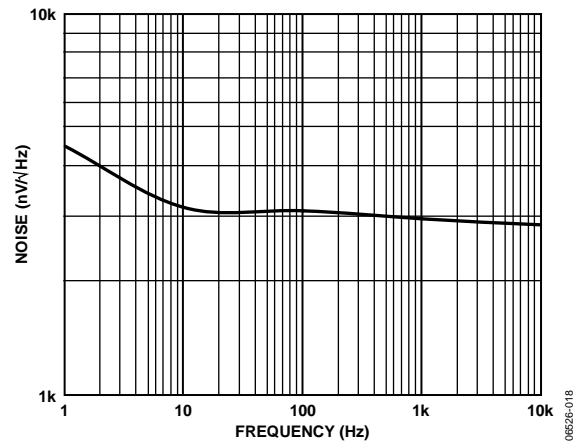

Figure 18. ADR5045 Voltage Noise Density

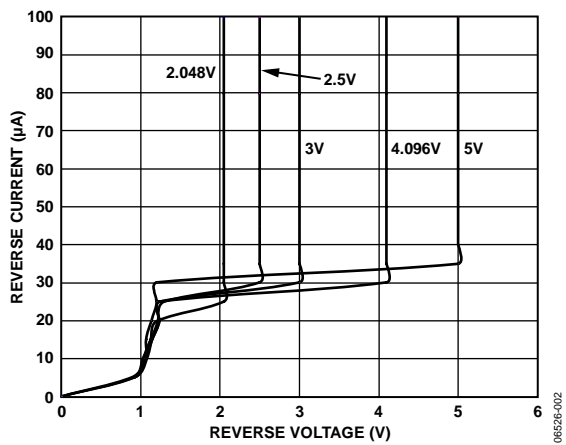

Figure 16. ADR5040/ADR5041/ADR5043/ADR5044/ADR5045 Reverse Characteristics and Minimum Operating Current

TERMINOLOGY

Temperature Coefficient

The change in output voltage with respect to operating temperature changes. It is normalized by an output voltage of 25°C. This parameter is expressed in ppm/°C and is determined by the following equation:

$$TCV_{OUT} \left[\frac{\text{ppm}}{^{\circ}\text{C}} \right] = \frac{V_{OUT}(T_2) - V_{OUT}(T_1)}{V_{OUT}(25^{\circ}\text{C}) \times (T_2 - T_1)} \times 10^6 \quad (1)$$

where:

$$V_{OUT}(25^{\circ}\text{C}) = V_{OUT} \text{ at } 25^{\circ}\text{C}.$$

$$V_{OUT}(T_1) = V_{OUT} \text{ at } -40^{\circ}\text{C}.$$

$$V_{OUT}(T_2) = V_{OUT} \text{ at } 125^{\circ}\text{C}.$$

Thermal Hysteresis

The change in output voltage after the device is cycled through temperatures ranging from +25°C to -40°C, then to +125°C, and back to +25°C. This is common in precision reference and is caused by thermal-mechanical package stress. Changes in environmental storage temperature, board mounting temperature, and the operating temperature are some of the factors that can contribute to thermal hysteresis. The following equation expresses a typical value from a sample of parts put through such a cycle:

$$V_{OUT_HYS} = V_{OUT}(25^{\circ}\text{C}) - V_{OUT_TC}$$

$$V_{OUT_HYS} [\text{ppm}] = \frac{V_{OUT}(25^{\circ}\text{C}) - V_{OUT_TC}}{V_{OUT}(25^{\circ}\text{C})} \times 10^6 \quad (2)$$

where:

$$V_{OUT}(25^{\circ}\text{C}) = V_{OUT} \text{ at } 25^{\circ}\text{C}.$$

V_{OUT_TC} = V_{OUT} at 25°C after a temperature cycle from +25°C to -40°C, then to +125°C, and back to +25°C.

THEORY OF OPERATION

The [ADR5040/ADR5041/ADR5043/ADR5044/ADR5045](#) use the band gap concept to produce a stable, low temperature coefficient voltage reference suitable for high accuracy data acquisition components and systems. The devices use the physical nature of a silicon transistor base-emitter voltage in the forward-biased operating region. All such transistors have approximately a $-2 \text{ mV}/^\circ\text{C}$ temperature coefficient (TC), making them unsuitable for direct use as a low temperature coefficient reference.

Extrapolation of the temperature characteristic of any one of these devices to absolute zero (with the collector current proportional to the absolute temperature), however, reveals that its V_{BE} approaches approximately the silicon band gap voltage. Therefore, if a voltage develops with an opposing temperature coefficient to sum the V_{BE} , a zero temperature coefficient reference results.

APPLICATIONS INFORMATION

The [ADR5040/ADR5041/ADR5043/ADR5044/ADR5045](#) are a series of precision shunt voltage references. They are designed to operate without an external capacitor between the positive and negative terminals. If a bypass capacitor is used to filter the supply, the references remain stable.

For a stable voltage, all shunt voltage references require an external bias resistor (R_{BIAS}) between the supply voltage and the reference (see Figure 19). The R_{BIAS} sets the current that flows through the load (I_L) and the reference (I_{IN}). Because the load and the supply voltage can vary, the R_{BIAS} needs to be chosen based on the following considerations:

- R_{BIAS} must be small enough to supply the minimum I_{IN} current to the [ADR5040/ADR5041/ADR5043/ADR5044/ADR5045](#), even when the supply voltage is at its minimum value and the load current is at its maximum value.
- R_{BIAS} must be large enough so that I_{IN} does not exceed 15 mA when the supply voltage is at its maximum value and the load current is at its minimum value.

Given these conditions, R_{BIAS} is determined by the supply voltage (V_S), the [ADR5040/ADR5041/ADR5043/ADR5044/ADR5045](#) load and operating current (I_L and I_{IN}), and the [ADR5040/ADR5041/ADR5043/ADR5044/ADR5045](#) output voltage (V_{OUT}).

$$R_{BIAS} = \frac{V_S - V_{OUT}}{I_L + I_{IN}} \quad (3)$$

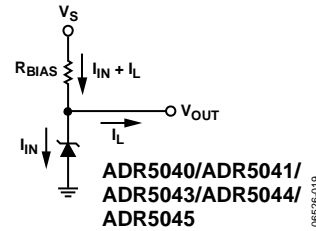

Figure 19. Shunt Reference

Precision Negative Voltage Reference

The [ADR5040/ADR5041/ADR5043/ADR5044/ADR5045](#) are suitable for applications where a precise negative voltage is desired. Figure 20 shows the [ADR5045](#) configured to provide a negative output. Exercise caution in using a low temperature sensitive resistor to avoid errors from the resistor.

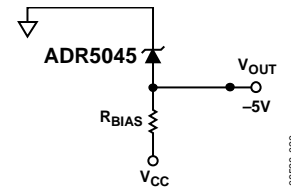

Figure 20. Negative Precision Reference Configuration

Stacking the [ADR5040/ADR5041/ADR5043/ADR5044/ADR5045](#) for User-Definable Outputs

Multiple [ADR5040/ADR5041/ADR5043/ADR5044/ADR5045](#) devices can be stacked together to allow the user to obtain a desired higher voltage. Figure 21a shows three [ADR5045](#) devices configured to give 15 V. The bias resistor, R_{BIAS} , is chosen using Equation 3, noting that the same bias current flows through all the shunt references in series. Figure 21b shows three [ADR5045](#) devices stacked together to give -15 V . R_{BIAS} is calculated in the same manner as before. Parts of different voltages can also be added together; that is, an [ADR5041](#) and an [ADR5045](#) can be added together to give an output of $+7.5 \text{ V}$ or -7.5 V , as desired. Note, however, that the initial accuracy error is the sum of the errors of all the stacked parts, as are the temperature coefficient and output voltage change vs. input current.

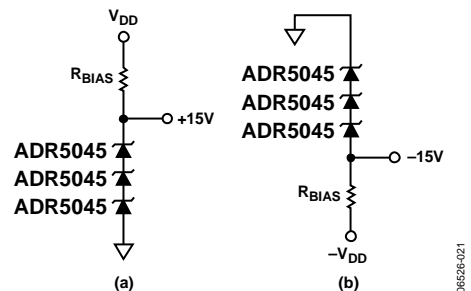

Figure 21. $\pm 15 \text{ V}$ Output with Stacked [ADR5045](#) Devices

Adjustable Precision Voltage Source

The [ADR5040/ADR5041/ADR5043/ADR5044/ADR5045](#), combined with a precision low input bias op amp such as the [AD8610](#), can be used to output a precise adjustable voltage. Figure 22 illustrates the implementation of this application using the [ADR5040/ADR5041/ADR5043/ADR5044/ADR5045](#). The output of the op amp, V_{OUT} , is determined by the gain of the circuit, which is completely dependent on the resistors, R1 and R2.

$$V_{OUT} = (1 + R2/R1)V_{REF}$$

An additional capacitor, C1, in parallel with R2, can be added to filter out high frequency noise. The value of C1 is dependent on the value of R2.

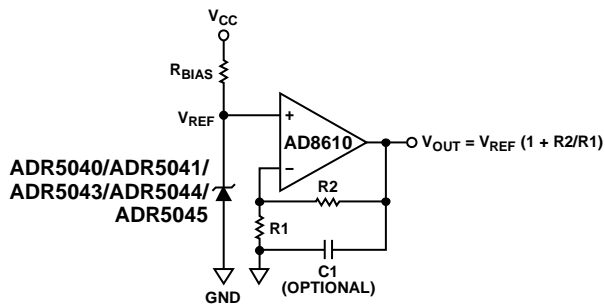

Figure 22. Adjustable Voltage Source

06526-022

Programmable Current Source

By using just a few ultrasmall and inexpensive parts, it is possible to build a programmable current source, as shown in Figure 23. The constant voltage on the gate of the transistor sets the current through the load. Varying the voltage on the gate changes the current. The [AD5247](#) is a digital potentiometer with I²C® digital interface, and the [AD8601](#) is a precision rail-to-rail input op amp. Each incremental step of the digital potentiometer increases or decreases the voltage at the noninverting input of the op amp. Therefore, this voltage varies with respect to the reference voltage.

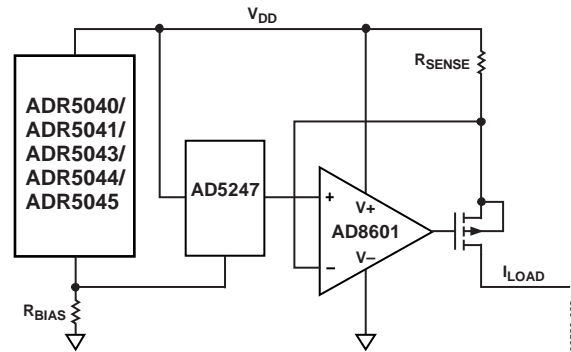

Figure 23. Programmable Current Source

06526-023

ORDERING GUIDE

| Model ^{1, 2} | Output Voltage (V) | Temperature Range | Package Description | Package Option | Ordering Quantity | Marking Code |
|-----------------------|--------------------|-------------------|---------------------|----------------|-------------------|--------------|
| ADR5040AKSZ-REEL7 | 2.048 | -40°C to +125°C | KS-SC-70 | KS-3 | 3,000 | R2J |
| ADR5040ARTZ-REEL7 | 2.048 | -40°C to +125°C | RT-SOT-23-3 | RT-3 | 3,000 | R2J |
| ADR5040BKSZ-REEL7 | 2.048 | -40°C to +125°C | KS-SC-70 | KS-3 | 3,000 | R2L |
| ADR5040BRTZ-REEL7 | 2.048 | -40°C to +125°C | RT-SOT-23-3 | RT-3 | 3,000 | R2L |
| ADR5040WARTZ-R7 | 2.048 | -40°C to +125°C | RT-SOT-23-3 | RT-3 | 3,000 | A3R |
| ADR5041AKSZ-REEL7 | 2.500 | -40°C to +125°C | KS-SC-70 | KS-3 | 3,000 | R2N |
| ADR5041ARTZ-REEL7 | 2.500 | -40°C to +125°C | RT-SOT-23-3 | RT-3 | 3,000 | R2N |
| ADR5041BKSZ-REEL7 | 2.500 | -40°C to +125°C | KS-SC-70 | KS-3 | 3,000 | R2Q |
| ADR5041BRTZ-REEL7 | 2.500 | -40°C to +125°C | RT-SOT-23-3 | RT-3 | 3,000 | R2Q |
| ADR5041WARTZ-R7 | 2.500 | -40°C to +125°C | RT-SOT-23-3 | RT-3 | 3,000 | R2N |
| ADR5041WBRTZ-R7 | 2.500 | -40°C to +125°C | RT-SOT-23-3 | RT-3 | 3,000 | R2Q |
| ADR5043AKSZ-REEL7 | 3.0 | -40°C to +125°C | KS-SC-70 | KS-3 | 3,000 | R2S |
| ADR5043ARTZ-REEL7 | 3.0 | -40°C to +125°C | RT-SOT-23-3 | RT-3 | 3,000 | R2S |
| ADR5043BKSZ-REEL7 | 3.0 | -40°C to +125°C | KS-SC-70 | KS-3 | 3,000 | R2U |
| ADR5043BRTZ-REEL7 | 3.0 | -40°C to +125°C | RT-SOT-23-3 | RT-3 | 3,000 | R2U |
| ADR5044AKSZ-REEL7 | 4.096 | -40°C to +125°C | KS-SC-70 | KS-3 | 3,000 | R2W |
| ADR5044ARTZ-REEL7 | 4.096 | -40°C to +125°C | RT-SOT-23-3 | RT-3 | 3,000 | R2W |
| ADR5044BKSZ-REEL7 | 4.096 | -40°C to +125°C | KS-SC-70 | KS-3 | 3,000 | R2Y |
| ADR5044BRTZ-REEL7 | 4.096 | -40°C to +125°C | RT-SOT-23-3 | RT-3 | 3,000 | R2Y |
| ADR5044WARTZ-R7 | 4.096 | -40°C to +125°C | RT-SOT-23-3 | RT-3 | 3,000 | R2W |
| ADR5044WBRTZ-R7 | 4.096 | -40°C to +125°C | RT-SOT-23-3 | RT-3 | 3,000 | R2Y |
| ADR5045AKSZ-REEL7 | 5.0 | -40°C to +125°C | KS-SC-70 | KS-3 | 3,000 | R30 |
| ADR5045ARTZ-REEL7 | 5.0 | -40°C to +125°C | RT-SOT-23-3 | RT-3 | 3,000 | R30 |
| ADR5045BKSZ-REEL7 | 5.0 | -40°C to +125°C | KS-SC-70 | KS-3 | 3,000 | R32 |
| ADR5045BRTZ-REEL7 | 5.0 | -40°C to +125°C | RT-SOT-23-3 | RT-3 | 3,000 | R32 |
| ADR5045WARTZ-REEL7 | 5.0 | -40°C to +125°C | KS-SC-70 | KS-3 | 3,000 | R3P |
| ADR5045WBRTZ-REEL7 | 5.0 | -40°C to +125°C | KS-SC-70 | KS-3 | 3,000 | R3Q |

¹ Z = RoHS Compliant Part.
² W = Qualified for Automotive Applications.

AUTOMOTIVE PRODUCTS

The [ADR5040W](#), [ADR5041W](#), [ADR5044W](#), and [ADR5045W](#) models are available with controlled manufacturing to support the quality and reliability requirements of automotive applications. Note that these automotive models may have specifications that differ from the commercial models; therefore, designers should review the Specifications section of this data sheet carefully. Only the automotive grade products shown are available for use in automotive applications. Contact your local Analog Devices account representative for specific product ordering information and to obtain the specific Automotive Reliability reports for these models.

I²C refers to a communications protocol originally developed by Philips Semiconductors (now NXP Semiconductors).

