

## Ordering Information

Part number	Enable	Voltage	Flag	Junction Temperature Range	Package
RoHS Compliant <sup>(1)</sup> / Pb-Free					
MIC37300-1.5WR <sup>(1)</sup>	No	1.5V	No	-40°C to +125°C	S-Pak-3
MIC37300-1.65WR <sup>(1)</sup>	No	1.65V	No	-40°C to +125°C	S-Pak-3
MIC37300-1.8WR <sup>(1)</sup>	No	1.8V	No	-40°C to +125°C	S-Pak-3
MIC37300-2.5WR <sup>(1)</sup>	No	2.5V	No	-40°C to +125°C	S-Pak-3
MIC37300-3.3WR <sup>(1)</sup>	No	3.3V	No	-40°C to +125°C	S-Pak-3
MIC37301-1.5YME	Yes	1.5V	Yes	-40°C to +125°C	ePad SOIC-8
MIC37301-1.5WR <sup>(1)</sup>	Yes	1.5V	Yes	-40°C to +125°C	S-Pak-5
MIC37301-1.8YME	Yes	1.8V	Yes	-40°C to +125°C	ePad SOIC-8
MIC37301-1.8WR <sup>(1)</sup>	Yes	1.8V	Yes	-40°C to +125°C	S-Pak-5
MIC37301-2.5YME	Yes	2.5V	Yes	-40°C to +125°C	ePad SOIC-8
MIC37301-2.5WR <sup>(1)</sup>	Yes	2.5V	Yes	-40°C to +125°C	S-Pak-5
MIC37301-3.3WR <sup>(1)</sup>	Yes	3.3V	Yes	-40°C to +125°C	S-Pak-5
MIC37302WR <sup>(1)</sup>	Yes	ADJ	No	-40°C to +125°C	S-Pak-5
MIC37302WU <sup>(1)</sup>	Yes	ADJ	No	-40°C to +125°C	TO-263-5
MIC37303YME	Yes	ADJ	Yes	-40°C to +125°C	ePad SOIC-8
MIC37303YML	Yes	ADJ	Yes	-40°C to +125°C	3mm x 3mm DFN

**Note:**

1. RoHS-compliant with 'high-melting solder' exemption.

## Pin Configuration

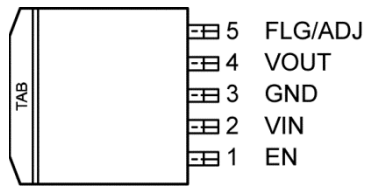

**S-PAK-5 (R)**  
(Top View)

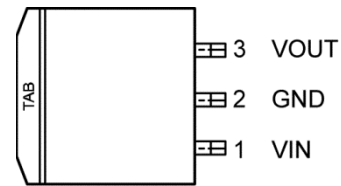

**S-PAK-3 (R)**  
(Top View)

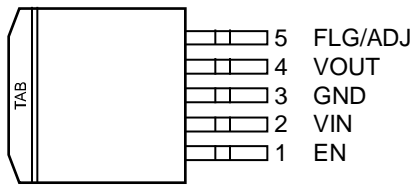

**TO-263-5 (U)**  
(Top View)

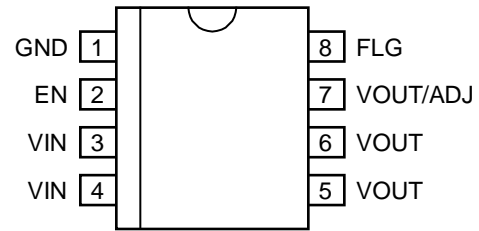

**e-Pad SOIC-8 (ME)**  
(Top View)

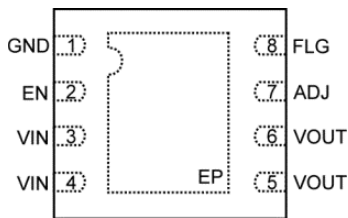

**3mm x 3mm DFN (ML)**  
(Top View)

## Pin Description

Pin Number S-PAK-5 TO-263-5	Pin Number S-PAK-3	Pin Number ePad SOIC-8 DFN	Pin Name	Pin Function
1	—	2	EN	Enable input: CMOS-compatible input. Logic HIGH = enable; Logic LOW = shutdown. Do not leave floating.
2	1	3, 4	VIN	Input voltage that supplies current to the output power device.
3	2	1	GND	Ground: TAB is connected to ground.
4	3	5, 6, 7 (Fixed) 5, 6 (Adj.)	VOUT	Regulator output.
5 (Fixed)	—	8	FLG	Error flag (output): Open collector output. Active LOW indicates an output fault condition.
5 (Adj.)	—	7 (Adj.)	ADJ	Adjustable regulator feedback input: Connect to resistor voltage driver.
—	—	EP	ePad	Connect to GND for best thermal performance.

**Absolute Maximum Ratings<sup>(2)</sup>**

Supply Voltage ( $V_{IN}$ )	6.5V
Enable Input Voltage ( $V_{EN}$ ) <sup>(4)</sup>	6.5V
Power Dissipation ( $P_D$ ) <sup>(4)</sup>	Internally Limited
Junction Temperature ( $T_J$ )	$-40^{\circ}\text{C} \leq T_J \leq +125^{\circ}\text{C}$
Storage Temperature ( $T_S$ )	$-65^{\circ}\text{C} \leq T_J \leq +150^{\circ}\text{C}$
Lead Temperature (soldering, 10s)	260°C
ESD Rating <sup>(5)</sup>	2kV

**Operating Ratings<sup>(3)</sup>**

Supply Voltage ( $V_{IN}$ )	2.25V to 6.0V
Enable Input Voltage ( $V_{EN}$ )	0V to 6.0V
Junction Temperature ( $T_J$ )	$-40^{\circ}\text{C} \leq T_J \leq +125^{\circ}\text{C}$
Package Thermal Resistance	
S-Pak ( $\theta_{JC}$ )	5.5°C/W
TO-263-5 ( $\theta_{JC}$ )	6.3°C/W
ePad SOIC-8 ( $\theta_{JC}$ )	16°C/W
3mm x 3mm DFN ( $\theta_{JC}$ )	29°C/W

**Electrical Characteristics<sup>(6)</sup>**

$T_A = 25^{\circ}\text{C}$  with  $V_{IN} = V_{OUT} + 1\text{V}$ ;  $V_{EN} = V_{IN}$ ;  $I_L = 10\text{mA}$ ; **bold** values indicate  $-40^{\circ}\text{C} < T_J < +125^{\circ}\text{C}$ , unless noted.

Parameter	Condition	Min.	Typ.	Max.	Units
Output Voltage Accuracy	$I_L = 10\text{mA}$	-1		+1	%
	$10\text{mA} < I_{OUT} < I_{L(max)}$ , $V_{OUT} + 1 \leq V_{IN} \leq 6\text{V}$	<b>-2</b>		<b>+2</b>	%
Output Voltage Line Regulation	$V_{IN} = V_{OUT} + 1.0\text{V}$ to $6.0\text{V}$ ; $I_L = 10\text{mA}$		0.02	0.5	%
Output Voltage Load Regulation	$I_L = 10\text{mA}$ to $3\text{A}$		0.2	<b>1</b>	%
$V_{IN} - V_{OUT}$ Dropout Voltage <sup>(7)</sup>	$I_L = 1.5\text{A}$ (ePad SOIC-8, DFN)		175	<b>350</b> <b>400</b>	mV
	$I_L = 3\text{A}$ (ePad SOIC-8, DFN)		300	<b>500</b> <b>550</b>	mV
Ground Pin Current <sup>(8)</sup>	$I_L = 3\text{A}$		27	40 <b>50</b>	mA mA
Ground Pin Current in Shutdown	$V_{IL} \leq 0.5\text{V}$ , $V_{IN} = V_{OUT} + 1\text{V}$		1.0	5	$\mu\text{A}$
Current Limit	$V_{OUT} = 0\text{V}$		4.75	<b>6.5</b>	A
Start-Up Time	$V_{EN} = V_{IN}$ , $I_{OUT} = 10\text{mA}$ , $C_{OUT} = 47\mu\text{F}$		170	<b>500</b>	$\mu\text{s}$

**Notes:**

- Exceeding the absolute maximum rating may damage the device.
- The device is not guaranteed to function outside its operating rating.
- $P_{D(max)} = (T_{J(max)} - T_A)/\theta_{JA}$ , where  $\theta_{JA}$ , depends upon the printed circuit layout. See "Application Information."
- Devices are ESD sensitive. Handling precautions recommended.
- Specification for packaged product only.
- $V_{DO} = V_{IN} - V_{OUT}$  when  $V_{OUT}$  decreases to 98% of its nominal output voltage with  $V_{IN} = V_{OUT} + 1\text{V}$ . For output voltages below 1.75, dropout voltage specification does not apply due to a minimum input operating voltage of 2.25V.
- $I_{GND}$  is the quiescent current.  $I_{IN} = I_{GND} + I_{OUT}$ .

## Electrical Characteristics<sup>(6)</sup> (Continued)

$T_A = 25^\circ\text{C}$  with  $V_{IN} = V_{OUT} + 1\text{V}$ ;  $V_{EN} = V_{IN}$ ;  $I_L = 10\text{mA}$ ; **bold** values indicate  $-40^\circ\text{C} < T_J < +125^\circ\text{C}$ , unless noted.

Parameter	Condition	Min.	Typ.	Max.	Units
<b>Enable Input</b>					
Enable Input Threshold	Regulator enable	<b>2.25</b>			V
	Regulator shutdown			<b>0.8</b>	
Enable Pin Input Current	$V_{IL} \leq 0.8\text{V}$ (Regulator shutdown)			2 <b>4</b>	$\mu\text{A}$
	$V_{IH} \geq 2.25\text{V}$ (Regulator enable)	1	15	30 <b>75</b>	$\mu\text{A}$
<b>Flag Output</b>					
$I_{FLG(LEAK)}$	$V_{OH} = 6\text{V}$			1 <b>2</b>	$\mu\text{A}$
$V_{FLG(LO)}$	$V_{IN} = 2.25\text{V}$ , $I_{OL} = 250\mu\text{A}$ <sup>(9)</sup>		210	400 <b>500</b>	mV
$V_{FLG}$	Low Threshold, % of $V_{OUT}$ below nominal	93			%
	Hysteresis		2		
	High Threshold, % of $V_{OUT}$ below nominal			99.2	
<b>MIC37302 Only</b>					
Reference Voltage		1.228 <b>1.215</b>	1.240	1.252 <b>1.265</b>	V
Adjust Pin Bias Current			40	80 <b>120</b>	nA

**Note:**

9. For a 2.5V device,  $V_{IN} = 2.250\text{V}$  (device is in dropout).

# Typical Characteristics

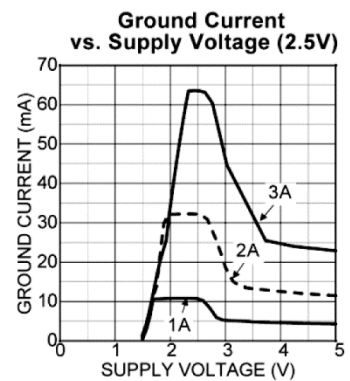
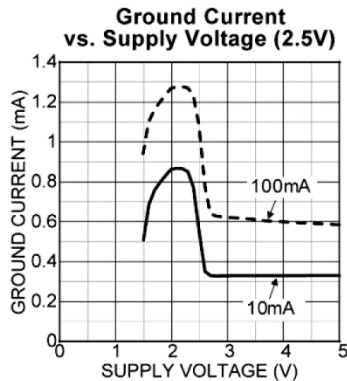
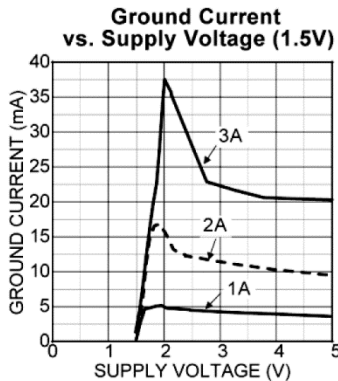
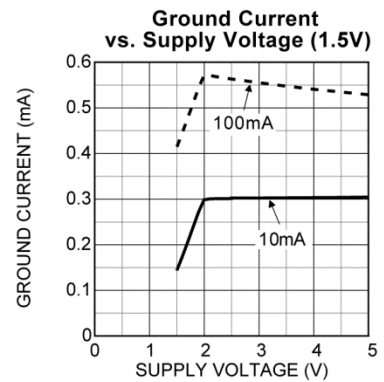
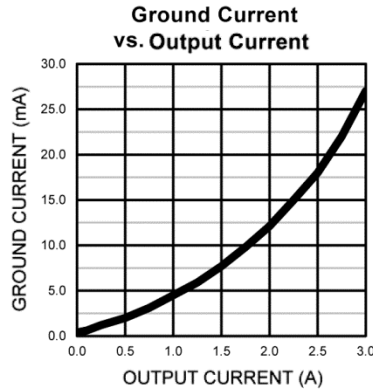
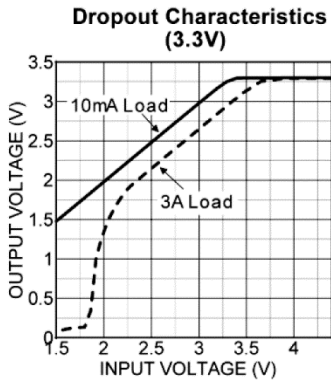
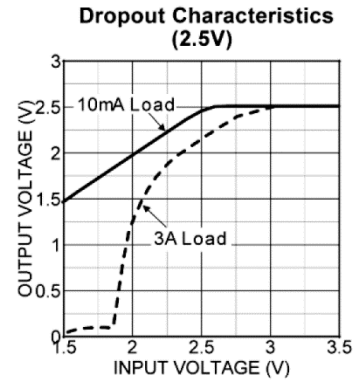
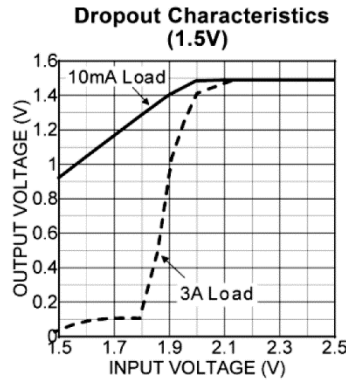
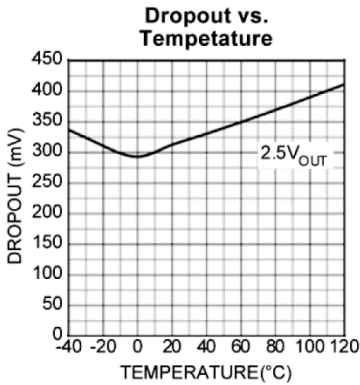
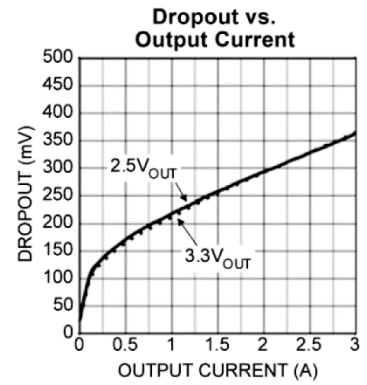
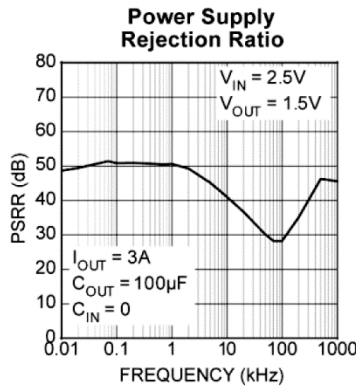
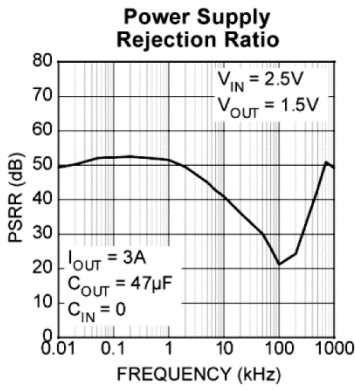

Typical Characteristics (Continued)

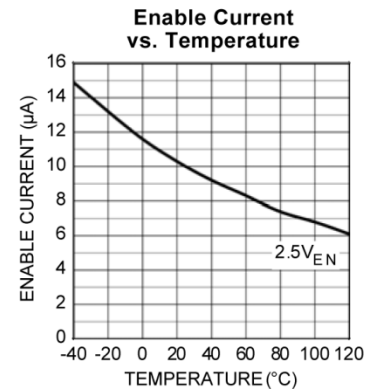
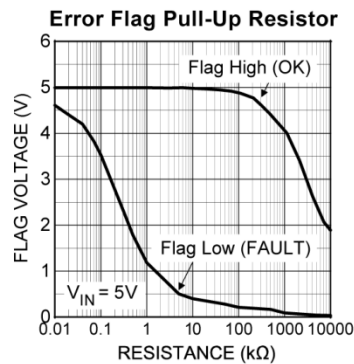
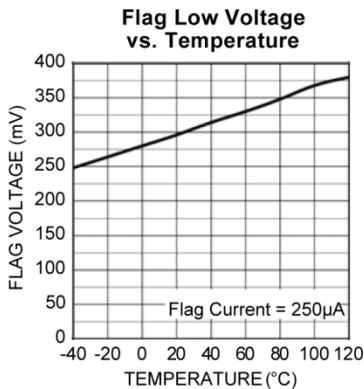
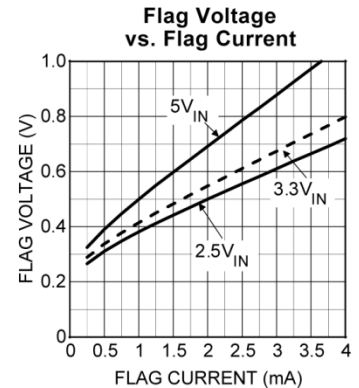
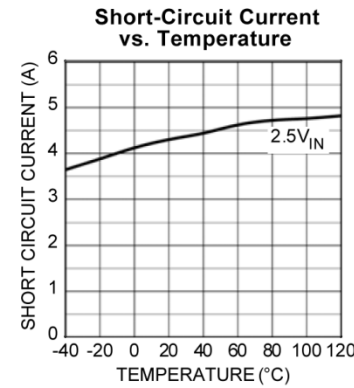
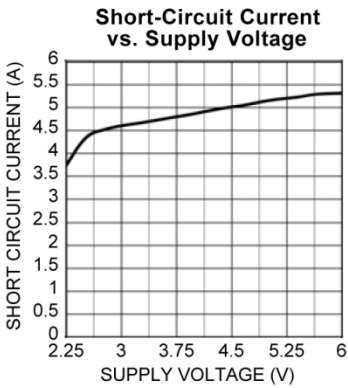
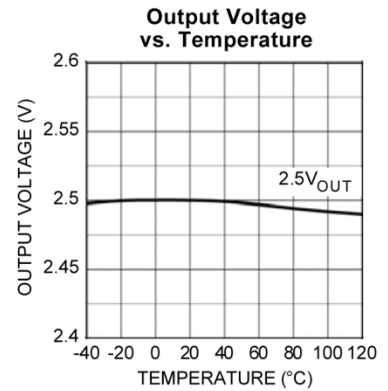
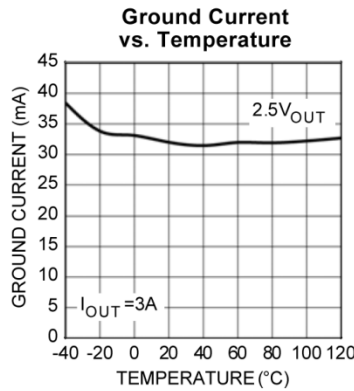
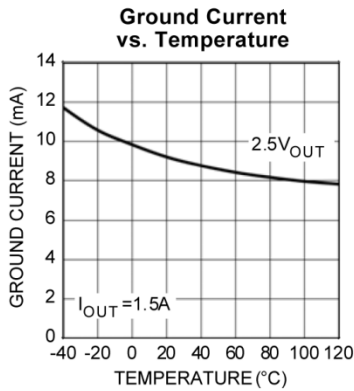
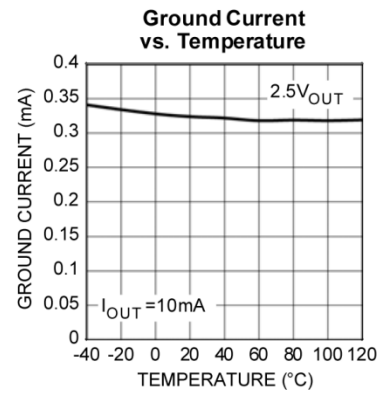
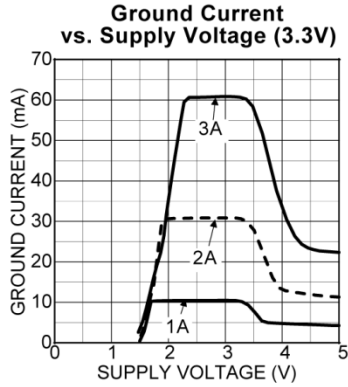
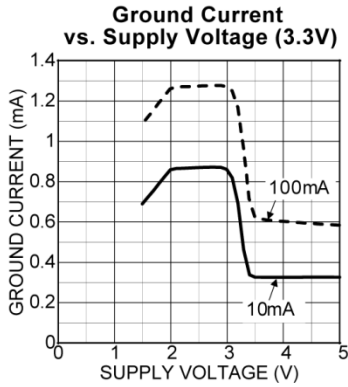

### Functional Characteristics

Load Transient Response

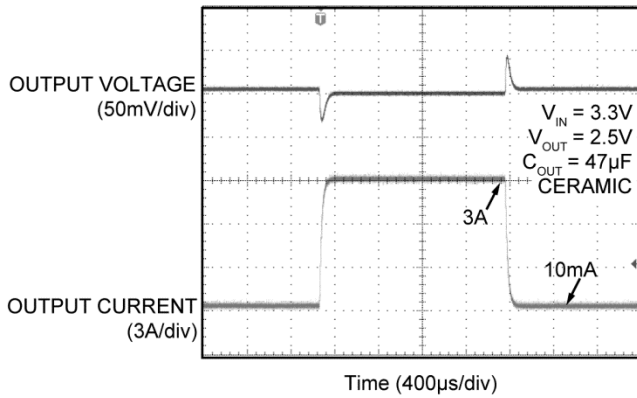

Line Transient Response

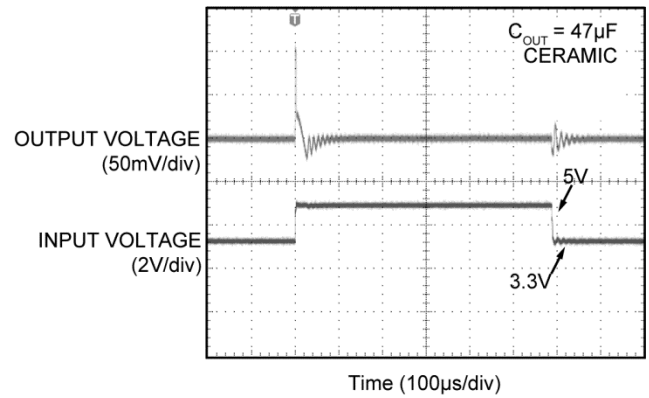

Enable Transient Response

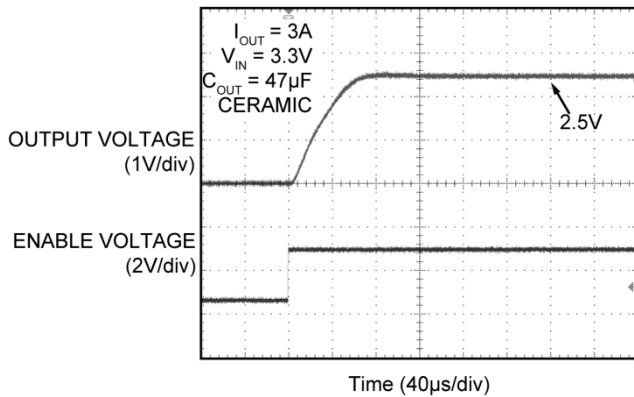

## Applications Information

The MIC37300/01/02/03 is a high-performance low-dropout voltage regulator suitable for moderate to high-current regulator applications. Its 500mV dropout voltage at full load and over temperature makes it especially valuable in battery-powered systems and as high-efficiency noise filters in post-regulator applications. Unlike older NPN-pass transistor designs, where the minimum dropout voltage is limited by the base-to-emitter voltage drop and collector-to-emitter saturation voltage, dropout performance of the PNP output of these devices is limited only by the low VCE saturation voltage.

A trade-off for the low dropout voltage is a varying base drive requirement. Micrel's Super  $\beta$  PNP<sup>®</sup> process reduces this drive requirement to only 2% to 5% of the load current.

The MIC37300/01/02/03 regulator is fully protected from damage due to fault conditions. Current-limiting is provided. This limiting is linear; output current during overload conditions is constant. Thermal shutdown disables the device when the die temperature exceeds the maximum safe operating temperature. The output structure of these regulators allows voltages in excess of the desired output voltage to be applied without reverse current flow.

### Thermal Design

Linear regulators are simple to use. The most complicated design parameters to consider are thermal characteristics. Thermal design requires the following application-specific parameters:

- Maximum ambient temperature ( $T_A$ )
- Output current ( $I_{OUT}$ )
- Output voltage ( $V_{OUT}$ )
- Input voltage ( $V_{IN}$ )
- Ground current ( $I_{GND}$ )

First, calculate the power dissipation of the regulator from these numbers and the device parameters from this datasheet (Equation 1):

$$P_D = (V_{IN} - V_{OUT}) I_{OUT} + V_{IN} I_{GND} \quad \text{Eq. 1}$$

where the ground current is approximated by using numbers from the "Electrical Characteristics" or "Typical Characteristics."

Then the heat sink thermal resistance is determined with Equation 2:

$$\theta_{SA} = ((T_{J(max)} - T_A)/P_D) - (\theta_{JC} + \theta_{CS}) \quad \text{Eq. 2}$$

where  $T_{J(max)} < 125^\circ\text{C}$  and  $\theta_{CS}$  is between  $0^\circ\text{C/W}$  and  $2^\circ\text{C/W}$ . The heat sink may be significantly reduced in applications where the minimum input voltage is known and is large compared with the dropout voltage. Use a series input resistor to drop excessive voltage and distribute the heat between this resistor and the regulator. The low-dropout properties of Micrel's Super  $\beta$  PNP regulators allow significant reductions in regulator power dissipation and the associated heat sink without compromising performance. When this technique is employed, a capacitor of at least  $1.0\mu\text{F}$  is needed directly between the input and regulator ground.

### Output Capacitor

The MIC37300/01/02/03 requires an output capacitor for stable operation. As a  $\mu\text{Cap}$  LDO, the MIC37300/01/02/03 can operate with ceramic output capacitors as long as the amount of capacitance is  $47\mu\text{F}$  or greater. For values of output capacitance lower than  $47\mu\text{F}$ , the recommended ESR range is  $200\text{m}\Omega$  to  $2\Omega$ . The minimum value of output capacitance recommended for the MIC37300 is  $10\mu\text{F}$ .

For  $47\mu\text{F}$  or greater, the ESR range recommended is less than  $1\Omega$ . Ultra-low ESR, ceramic capacitors are recommended for output capacitance of  $47\mu\text{F}$  or greater to help improve transient response and noise reduction at high frequency. X7R/X5R dielectric-type ceramic capacitors are recommended because of their temperature performance. X7R-type capacitors change capacitance by 15% over their operating temperature range and are the most stable type of ceramic capacitors. Z5U and Y5V dielectric capacitors change value by as much as 50% and 60%, respectively, over their operating temperature ranges. To use a ceramic chip capacitor with Y5V dielectric, the value must be much higher than an X7R ceramic capacitor to ensure the same minimum capacitance over the equivalent operating temperature range.



### Input Capacitor

An input capacitor of 1.0 $\mu$ F or greater is recommended when the device is more than 4 inches away from the bulk supply capacitance, or when the supply is a battery. Small, surface-mount chip capacitors can be used for the bypassing. The capacitor should be placed within 1 inch of the device for optimal performance. Larger values will help to improve ripple rejection by bypassing the input to the regulator, further improving the integrity of the output voltage.

### Transient Response and 3.3V to 2.5V, 2.5V to 1.8V or 1.65V, or 2.5V to 1.5V Conversions

The MIC37300/01/02/03 has excellent transient response to variations in input voltage and load current. The device has been designed to respond quickly to load current variations and input voltage variations. Large output capacitors are not required to obtain this performance. A standard 47 $\mu$ F output capacitor, preferably tantalum, is all that is required. Larger values help to improve performance even further.

By virtue of its low-dropout voltage, this device does not saturate into dropout as readily as similar NPN-based designs. When converting from 3.3V to 2.5V, 2.5V to 1.8V or 1.65V, or 2.5V to 1.5V, the NPN-based regulators are already operating in dropout, with typical dropout requirements of 1.2V or greater. To convert down to 2.5V without operating in dropout, NPN-based regulators require an input voltage of 3.7V at the very least. The MIC37300/01/02/03 regulator will provide excellent performance with an input as low as 3.0V or 2.25V, respectively. This gives the PNP-based regulators a distinct advantage over older, NPN-based linear regulators.

### Minimum Load Current

The MIC37300/01/02/03 regulator is specified between finite loads. If the output current is too small, then the leakage currents dominate and the output voltage rises. A 10mA minimum load current is necessary for proper operation. For adjustable regulators, this can be accomplished by selecting the feedback resistors to load the output with 10mA.

### Error Flag

The MIC37301 and MIC37303 feature an error flag circuit that monitors the output voltage and signals an error condition when the voltage is 5% below the nominal output voltage. The error flag is an open-collector output that can sink 10mA during a fault condition.

Low output voltage can be caused by a number of problems, including an overcurrent fault (device in current limit) or low input voltage. The flag is inoperative during overtemperature shutdown.

### Enable Input

The MIC37301/02/03 also features an enable input for on/off control of the device. Its shutdown state draws “zero” current (only microamperes of leakage). The enable input is TTL/CMOS compatible for simple logic interface, but can be connected up to  $V_{IN}$ . When enabled, it draws approximately 15 $\mu$ A.

### Adjustable Regulator Design

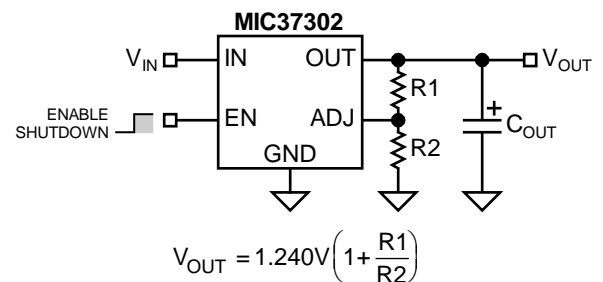

Figure 1. Adjustable Regulator with Resistors

The MIC37302 and MIC37303 allow programming the output voltage anywhere between 1.24V and the 5.5V maximum operating rating of the family. Two resistors are used. Resistors can be quite large, up to 1M $\Omega$ , because of the very high input impedance and low bias current of the sense comparator.

The resistor values are calculated by:

$$R1 = R2 \left( \frac{V_{OUT}}{1.240} - 1 \right) \quad \text{Eq. 3}$$

where  $V_{OUT}$  is the desired output voltage. Figure 1 shows component definition. Applications with widely varying load currents may scale the resistors to draw the minimum load current required for proper operation.

Package Information<sup>(10)</sup>

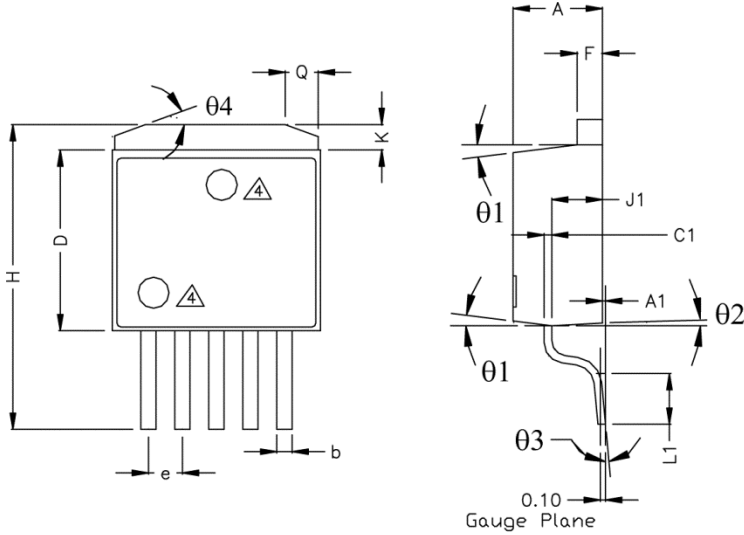

TOP VIEW

SIDE VIEW 1

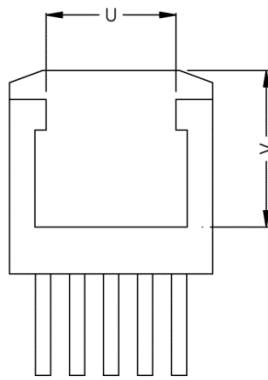

BOTTOM VIEW

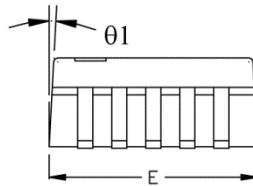

SIDE VIEW 2

POS	INCH		MM	
	MIN	MAX	MIN	MAX
A	0.170	0.181	4.318	4.597
A1	0.000	0.012	0.000	0.305
b	0.026	0.036	0.660	0.914
C1	0.012	0.023	0.305	0.584
D	0.330	0.361	8.392	9.169
E	0.396	0.420	10.058	10.668
e	0.062	0.072	1.575	1.829
F	0.045	0.055	1.143	1.397
H	0.575	0.625	14.605	15.875
J1	0.080	0.120	2.032	3.048
K	0.045	0.066	1.143	1.676
L1	0.090	0.110	2.286	2.794
theta1	3°	10°	3°	10°
theta2	1°	7°	1°	7°
theta3	0°	8°	0°	8°
theta4	18°	22°	18°	22°
Q	0.055	0.075	1.397	1.905
U	0.256	Ref.	6.502	Ref.
V	0.305	Ref.	7.747	Ref.

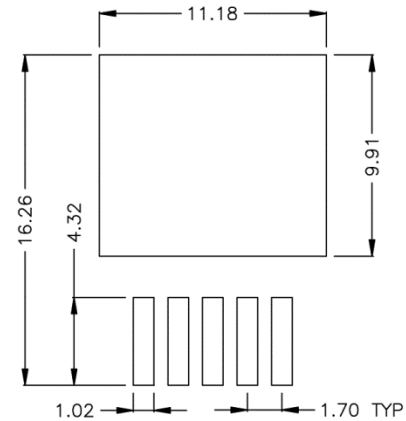

RECOMMENDED LAND PATTERN  
(UNIT : mm)

- NOTE:
1. PACKAGE OUTLINE EXCLUSIVE OF MOLD FLASH & METAL BURR.
  2. PACKAGE OUTLINE INCLUSIVE OF PLATING THICKNESS.
  3. FOOT LENGTH USING GAUGE PLANE METHOD MEASUREMENT 0.010"
  4. PACKAGE TOP MARK MAY BE IN TOP CENTER OR LOWER LEFT CORNER
  5. ALL DIMENSIONS ARE IN INCHES/MILLIMETERS.

5-Pin TO-263-5 (U)

Note:

10. Package information is correct as of the publication date. For updates and most current information, go to [www.micrel.com](http://www.micrel.com).

Package Information<sup>(10)</sup> (Continued)

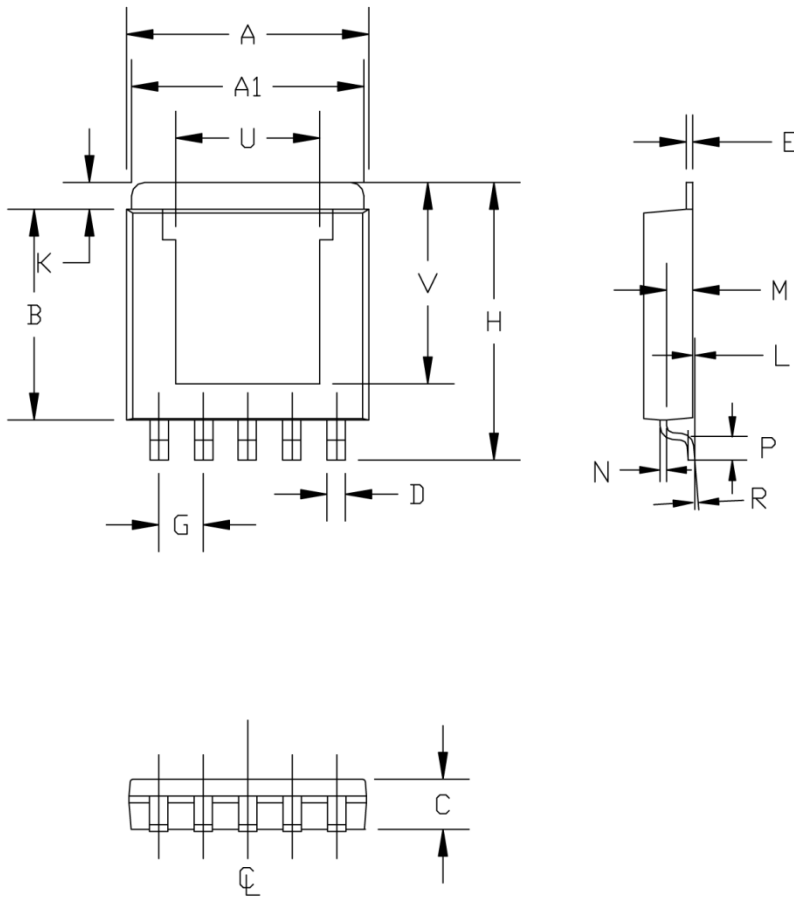

	INCHES		MILLIMETERS	
A	0.365	0.375	9.27	9.52
A1	0.350	0.360	8.89	9.14
B	0.310	0.320	7.87	8.13
C	0.070	0.080	1.78	2.03
D	0.025	0.031	0.63	0.79
E	0.010	BSC	0.25	BSC
G	0.067	BSC	1.70	BSC
H	0.410	0.420	10.41	10.67
K	0.030	0.050	0.76	1.27
L	0.001	0.005	0.03	0.13
M	0.035	0.045	0.89	1.14
N	0.010	BSC	0.25	BSC
P	0.031	0.041	0.79	1.04
R	0°	6°	0°	6°
U	0.220	BSC	5.58	BSC
V	0.296	BSC	7.52	BSC

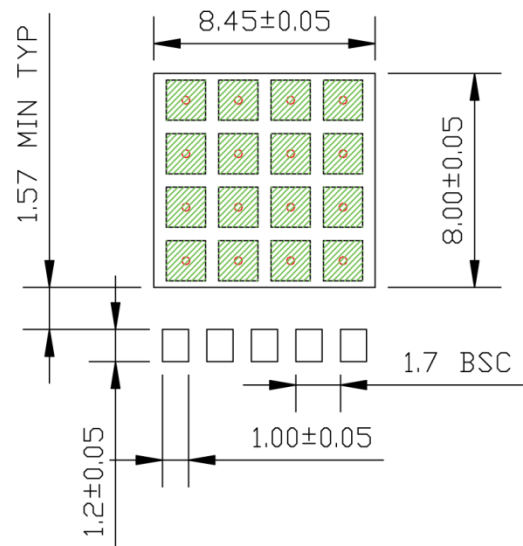

- NOTE:
1. DIMENSION DOES NOT INCLUDE MOLD FLASH OR PROTRUSIONS.
  2. DIMENSION INCLUDES PLATING THICKNESS. SOLDER MASK OPENING
  3. RED CIRCLES IN LAND PATTERN REPRESENT THERMAL VIA, 0.30MM IN DIAMETER & SHOULD BE CONNECTED TO GND FOR MAXIMUM PERFORMANCE
  4. GREEN RECTANGLES IN LAND PATTERN REPRESENT SOLDER STENCIL OPENING (OPTIONAL), 1.50X1.50MM.

RECOMMENDED  
LAND PATTERN

5-Pin S-PAK (R)

Package Information<sup>(10)</sup> (Continued)

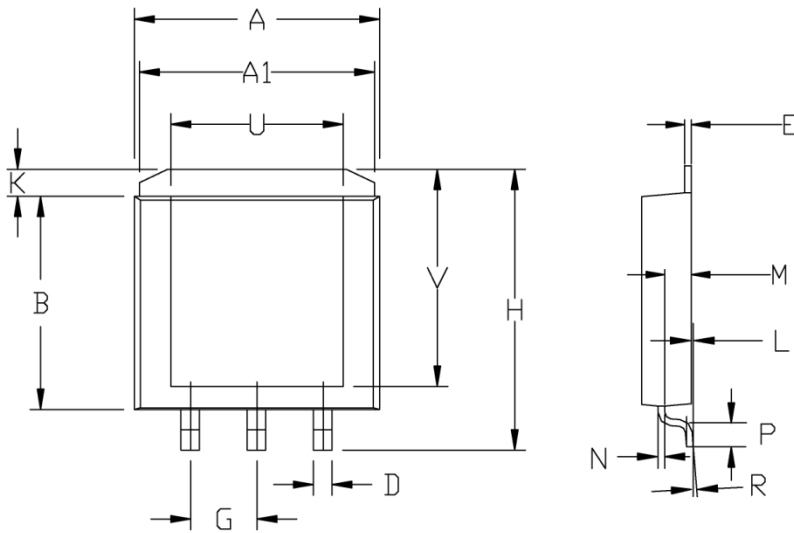

	INCHES		MILLIMETERS	
A	0.365	0.375	9.27	9.52
A1	0.350	0.360	8.89	9.14
B	0.310	0.320	7.87	8.13
C	0.070	0.080	1.78	2.03
D	0.025	0.031	0.63	0.79
E	0.010	BSC	0.25	BSC
G	0.100	BSC	2.54	BSC
H	0.410	0.420	10.41	10.67
K	0.030	0.050	0.76	1.27
L	0.001	0.005	0.03	0.13
M	0.035	0.045	0.89	1.14
N	0.010	BSC	0.25	BSC
P	0.031	0.041	0.79	1.04
R	0°	6°	0°	6°
U	0.256	BSC	6.50	BSC
V	0.316	BSC	8.03	BSC

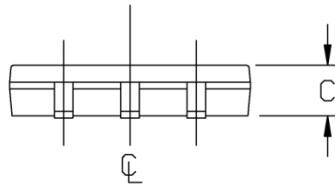

- NOTE:
1. DIMENSION DOES NOT INCLUDE MOLD FLASH OR PROTRUSIONS.
  2. DIMENSION INCLUDES PLATING THICKNESS. SOLDER MASK OPENING
  3. RED CIRCLES IN LAND PATTERN REPRESENT THERMAL VIA, 0.30MM IN DIAMETER & SHOULD BE CONNECTED TO GND FOR MAXIMUM PERFORMANCE
  4. GREEN RECTANGLES IN LAND PATTERN REPRESENT SOLDER STENCIL OPENING (OPTIONAL), 1.50X1.50MM.

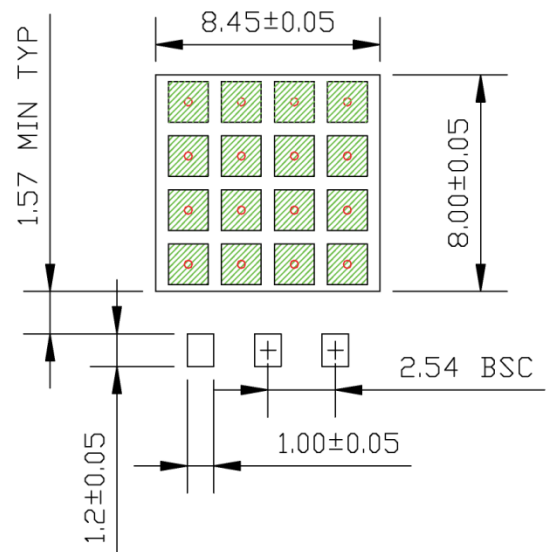

RECOMMENDED LAND PATTERN (UNIT: MM)

3-Pin S-PAK (R)

Package Information<sup>(10)</sup> (Continued)

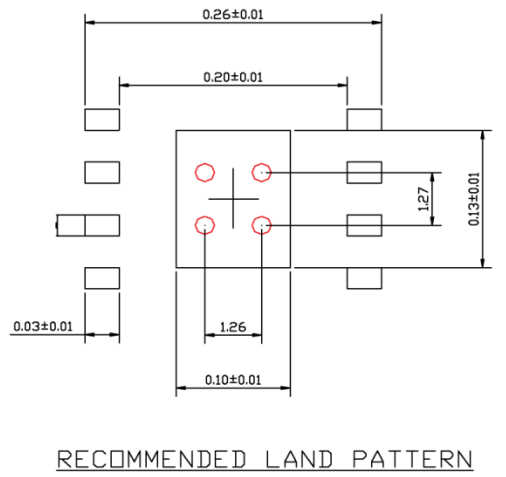
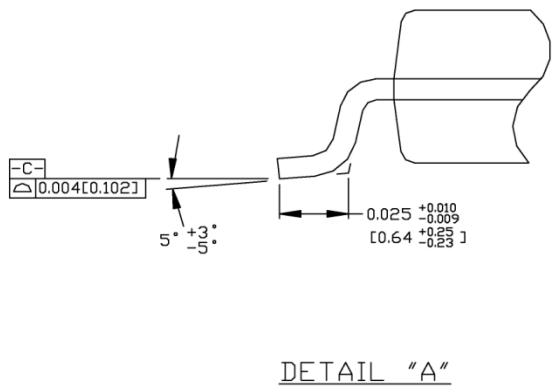
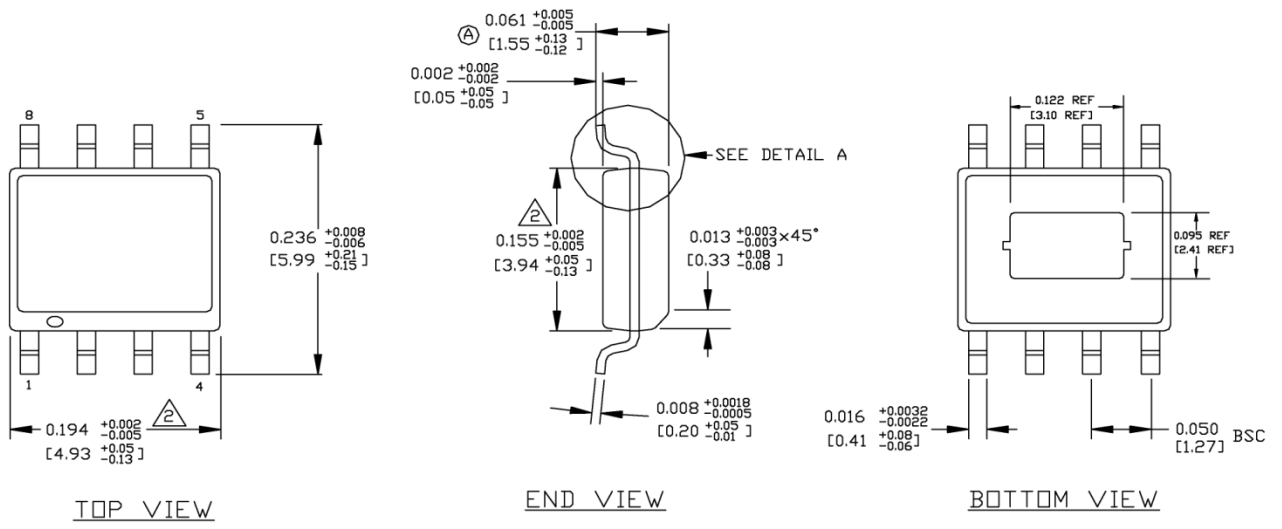

NOTE:  
 1. DIMENSION DOES NOT INCLUDE MOLD FLASH OR PROTRUSIONS, EITHER OF WHICH SHALL EXCEED 0.006 INCHES PER SIDE  
 RED CIRCLES IN LAND PATTERN REPRESENT THERMAL VIAS. RECOMMENDED SIZE IS 0.30-0.30MM IN DIAMETER AND SHOULD BE CONNECTED TO GND FOR MAXIMUM THERMAL PERFORMANCE

**ePad SOIC-8 (ME)**

Package Information<sup>(10)</sup> (Continued)

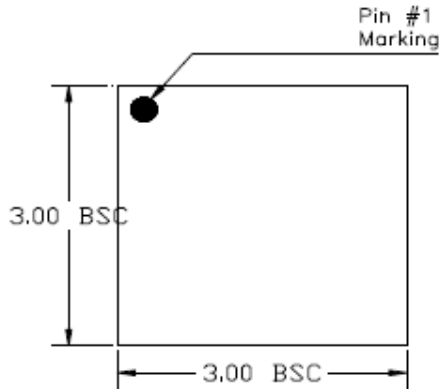

TOP VIEW  
NOTE: 1, 2, 3

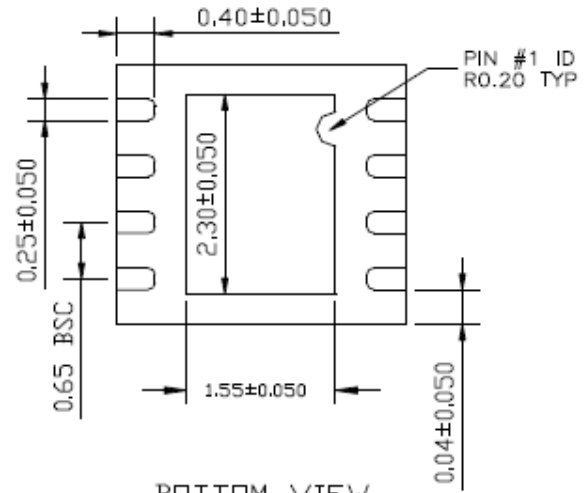

BOTTOM VIEW  
NOTE: 1, 2, 3

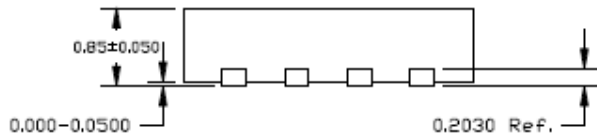

SIDE VIEW  
NOTE: 1, 2, 3

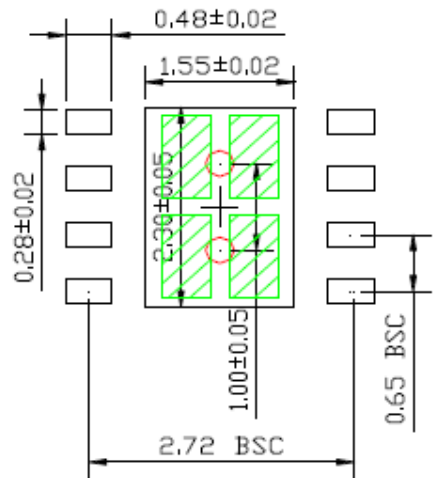

RECOMMENDED LAND PATTERN  
NOTE: 4, 5

NOTE:

1. MAX PACKAGE WARPAGE IS 0.05 MM
2. MAX ALLOWABLE BURR IS 0.076MM IN ALL DIRECTIONS
3. PIN #1 IS ON TOP WILL BE LASER MARKED
4. RED CIRCLE IN LAND PATTERN INDICATE THERMAL VIA. SIZE SHOULD BE 0.30-0.3MM IN DIAMETER AND SHOULD BE CONNECTED TO GND FOR MAX THERMAL PERFORMANCE
5. GREEN RECTANGLES (SHADED AREA) INDICATE SOLDER STENCIL OPENING ON EXPOSED PAD AREA. SIZE SHOULD BE 0.50x0.95 MM IN SIZE, 0.20 MM SPACING.

**8-Pin 3mm x 3mm DFN (ML)**

---

**MICREL, INC. 2180 FORTUNE DRIVE SAN JOSE, CA 95131 USA**TEL +1 (408) 944-0800 FAX +1 (408) 474-1000 WEB <http://www.micrel.com>

Micrel, Inc. is a leading global manufacturer of IC solutions for the worldwide high performance linear and power, LAN, and timing & communications markets. The Company's products include advanced mixed-signal, analog & power semiconductors; high-performance communication, clock management, MEMs-based clock oscillators & crystal-less clock generators, Ethernet switches, and physical layer transceiver ICs. Company customers include leading manufacturers of enterprise, consumer, industrial, mobile, telecommunications, automotive, and computer products. Corporation headquarters and state-of-the-art wafer fabrication facilities are located in San Jose, CA, with regional sales and support offices and advanced technology design centers situated throughout the Americas, Europe, and Asia. Additionally, the Company maintains an extensive network of distributors and reps worldwide.

Micrel makes no representations or warranties with respect to the accuracy or completeness of the information furnished in this datasheet. This information is not intended as a warranty and Micrel does not assume responsibility for its use. Micrel reserves the right to change circuitry, specifications and descriptions at any time without notice. No license, whether express, implied, arising by estoppel or otherwise, to any intellectual property rights is granted by this document. Except as provided in Micrel's terms and conditions of sale for such products, Micrel assumes no liability whatsoever, and Micrel disclaims any express or implied warranty relating to the sale and/or use of Micrel products including liability or warranties relating to fitness for a particular purpose, merchantability, or infringement of any patent, copyright, or other intellectual property right.

Micrel Products are not designed or authorized for use as components in life support appliances, devices or systems where malfunction of a product can reasonably be expected to result in personal injury. Life support devices or systems are devices or systems that (a) are intended for surgical implant into the body or (b) support or sustain life, and whose failure to perform can be reasonably expected to result in a significant injury to the user. A Purchaser's use or sale of Micrel Products for use in life support appliances, devices or systems is a Purchaser's own risk and Purchaser agrees to fully indemnify Micrel for any damages resulting from such use or sale.

© 2003 Micrel, Incorporated.