

## TABLE OF CONTENTS

Features .....	1	Upconverter Performance .....	8
Applications .....	1	Isolation and Return Loss .....	9
Functional Block Diagram .....	1	IF Bandwidth—Downconverter .....	11
General Description .....	1	IF Bandwidth—Upconverter .....	12
Revision History .....	2	Spurious and Harmonics Performance .....	13
Specifications .....	3	Theory of Operation .....	14
Absolute Maximum Ratings .....	4	Applications Information .....	15
Thermal Resistance .....	4	Typical Application Circuit .....	15
ESD Caution .....	4	Evaluation PCB Information .....	15
Pin Configuration and Function Descriptions .....	5	Outline Dimensions .....	16
Interface Schematics .....	5	Ordering Guide .....	16
Typical Performance Characteristics .....	6		
Downconverter Performance .....	6		

## REVISION HISTORY

1/2018—Revision 0: Initial Version

## SPECIFICATIONS

Ambient temperature ( $T_A$ ) = 25°C, IF = 1000 MHz, LO = 13 dBm, upper sideband. All measurements performed as a downconverter on the evaluation printed circuit board (PCB), unless otherwise noted.

Table 1.

Parameter	Symbol	Min	Typ	Max	Unit	Test Conditions/Comments	
FREQUENCY RANGE							
RF		10		26	GHz		
LO Input		10		26	GHz		
IF		dc		8	GHz		
LO AMPLITUDE							
		9	13	15	dBm		
10 GHz TO 18 GHz PERFORMANCE							
Downconverter							
Conversion Loss			8	10	dB	IF <sub>IN</sub> = 1000 MHz	
Single Sideband Noise Figure	SSB NF		8		dB		
Input Third-Order Intercept	IIP3	13	18		dBm		
Input 1 dB Compression Point	IP1dB		9.5		dBm		
Input Second-Order Intercept	IIP2		43		dBm		
Upconverter							
Conversion Loss			7		dB		
Input Third-Order Intercept	IIP3		18		dBm		
Input 1 dB Compression Point	IP1dB		7		dBm		
Isolation							
RF to IF		14	21		dB		
LO to RF			40		dB		
LO to IF		25	35		dB		
18 GHz TO 26 GHz PERFORMANCE							
Downconverter							
Conversion Loss			9	12	dB	IF <sub>IN</sub> = 1000 MHz	
Single Sideband Noise Figure	SSB NF		10		dB		
Input Third-Order Intercept	IIP3	18	23		dBm		
Input 1 dB Compression Point	IP1dB		13		dBm		
Input Second-Order Intercept	IIP2		46		dBm		
Upconverter							
Conversion Loss			8		dB		
Input Third-Order Intercept	IIP3		19		dBm		
Input 1 dB Compression Point	IP1dB		8.5		dBm		
Isolation							
RF to IF		25	35		dB		
LO to RF			40		dB		
LO to IF		30	43		dB		

## ABSOLUTE MAXIMUM RATINGS

Table 2.

Parameter	Rating
RF Input Power	25 dBm
LO Input Power	27 dBm
IF Input Power	25 dBm
IF Source/Sink Current	3 mA
Peak Reflow Temperature	260°C
Continuous Power Dissipation, $P_{Diss}$ ( $T_A = 85^\circ\text{C}$ , Derate 5 mW/ $^\circ\text{C}$ Above 85°C)	260 mW
Operating Temperature Range	-40°C to +85°C
Storage Temperature Range	-65°C to +150°C
Lead Temperature Range	-65°C to +150°C
Electrostatic Discharge (ESD) Sensitivity	
Human Body Model	500 V
Field Induced Charged Device Model	1000 V

Stresses at or above those listed under Absolute Maximum Ratings may cause permanent damage to the product. This is a stress rating only; functional operation of the product at these or any other conditions above those indicated in the operational section of this specification is not implied. Operation beyond the maximum operating conditions for extended periods may affect product reliability.

## THERMAL RESISTANCE

Thermal performance is directly linked to printed circuit board (PCB) design and operating environment. Careful attention to PCB thermal design is required.

$\theta_{JA}$  is the natural convection junction to ambient thermal resistance measured in a one cubic foot sealed enclosure.  $\theta_{JC}$  is the junction to case thermal resistance.

Table 3. Thermal Resistance

Package Type	$\theta_{JA}$	$\theta_{JC}$	Unit
E-12-4 <sup>1</sup>	120	200	$^\circ\text{C}/\text{W}$

<sup>1</sup> See JEDEC standard JESD51-2 for additional information on optimizing the thermal impedance (PCB with 3 × 3 vias).

## ESD CAUTION



**ESD (electrostatic discharge) sensitive device.** Charged devices and circuit boards can discharge without detection. Although this product features patented or proprietary protection circuitry, damage may occur on devices subjected to high energy ESD. Therefore, proper ESD precautions should be taken to avoid performance degradation or loss of functionality.

# PIN CONFIGURATION AND FUNCTION DESCRIPTIONS

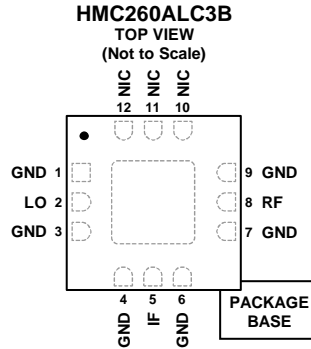

**NOTES**  
 1. NIC = NOT INTERNALLY CONNECTED. THESE PINS CAN BE CONNECTED TO RF/DC GROUND. PERFORMANCE IS NOT AFFECTED.  
 2. EXPOSED PAD. THE EXPOSED PAD MUST BE CONNECTED TO RF/DC GROUND.

Figure 2.

Table 4. Pin Function Descriptions

Pin No.	Mnemonic	Description
1, 3, 4, 6, 7, 9	GND	Ground. These pins and package bottoms connect to RF/dc ground.
2	LO	Local Oscillator Port. This pin is ac-coupled and matched to 50 Ω.
5	IF	Intermediate Frequency Port. This pin is dc-coupled. For applications, not requiring operation to dc, dc block this port externally using a series capacitor of a value chosen to pass the necessary IF frequency range. For operation to dc, this pin must not source or sink more than 3 mA of current or die malfunction and possible die failure may result. See Figure 5 for the interface schematic.
8	RF	Radio Frequency Port. This pin is ac-coupled and matched to 50 Ω.
10 to 12	NIC EPAD	Not Internally Connected. These pins can be connected to RF/dc ground. Device performance is not affected. Exposed Pad. The exposed pad must be connected to RF/dc ground.

## INTERFACE SCHEMATICS



Figure 3. GND Interface Schematic

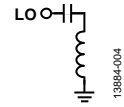

Figure 4. LO Interface Schematic

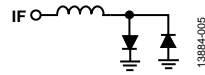

Figure 5. IF Interface Schematic

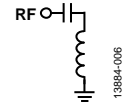

Figure 6. RF Interface Schematic

# TYPICAL PERFORMANCE CHARACTERISTICS

## DOWNCONVERTER PERFORMANCE

Downconverter performance at IF = 1000 MHz, upper sideband (low-side LO).

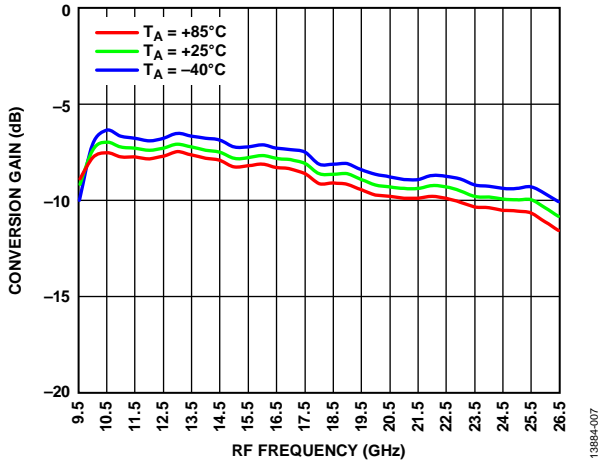

Figure 7. Conversion Gain vs. RF Frequency at Various Temperatures, LO = 13 dBm

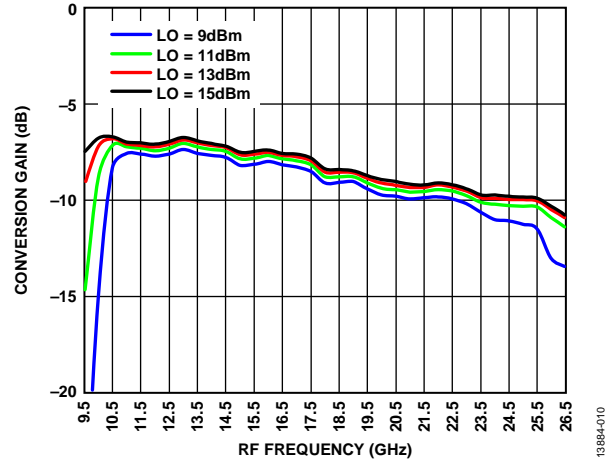

Figure 10. Conversion Gain vs. RF Frequency at Various LO Power Levels, TA = 25°C

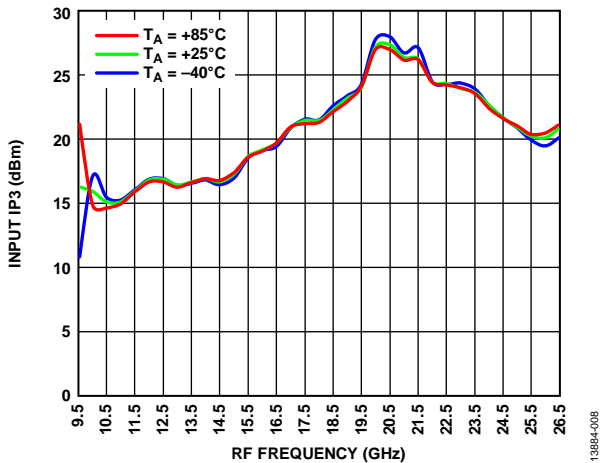

Figure 8. Input IP3 vs. RF Frequency at Various Temperatures, LO = 13 dBm

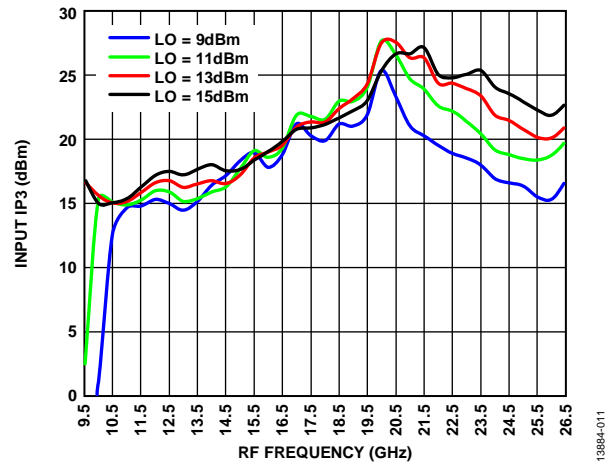

Figure 11. Input IP3 vs. RF Frequency at Various LO Power Levels, TA = 25°C

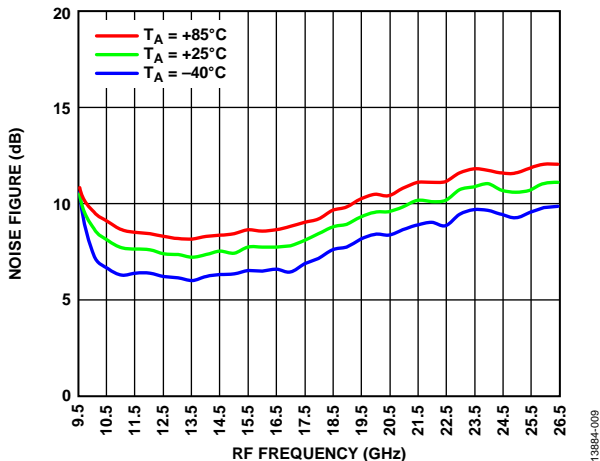

Figure 9. Noise Figure vs. RF Frequency at Various Temperatures, LO = 13 dBm

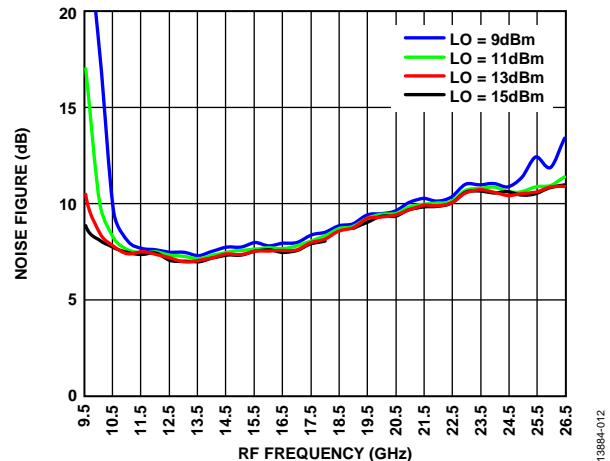

Figure 12. Noise Figure vs. RF Frequency at Various LO Power Levels, TA = 25°C

**Downconverter P1dB and IP2**

IF = 1000 MHz, upper sideband (low-side LO).

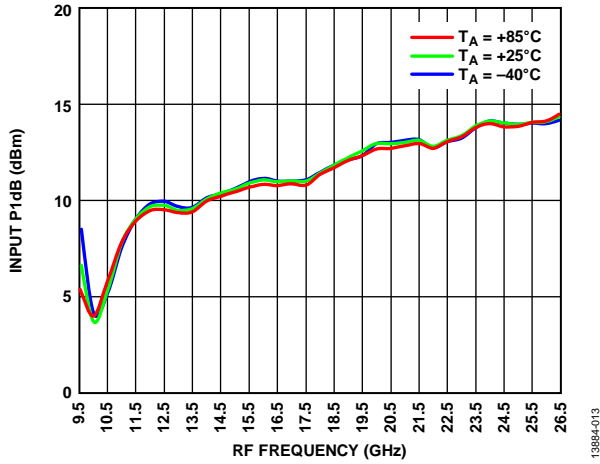

Figure 13. Input P1dB vs. RF Frequency at Various Temperatures, LO = 13 dBm

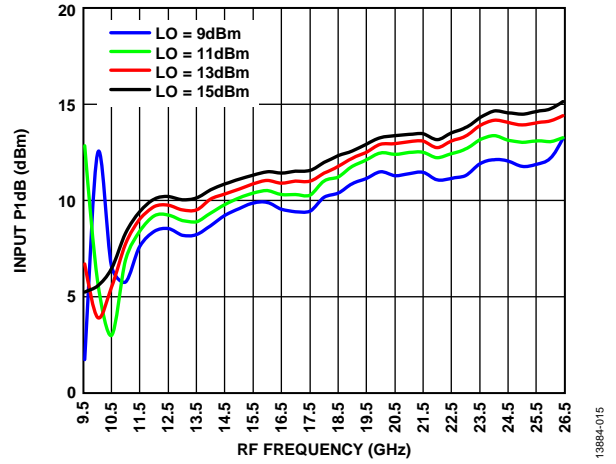

Figure 15. Input P1dB vs. RF Frequency at Various LO Power Levels, TA = 25°C

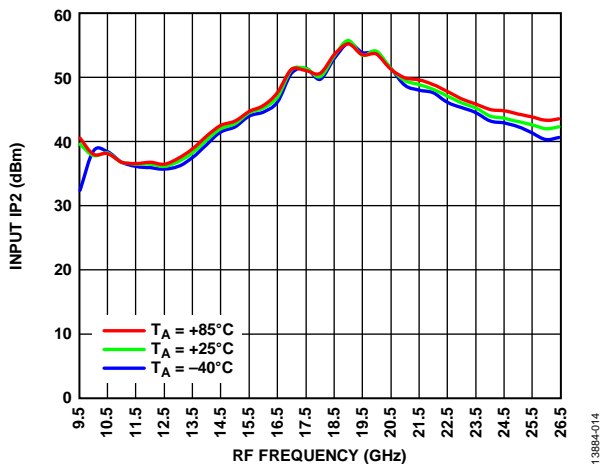

Figure 14. Input IP2 vs. RF Frequency at Various Temperatures, LO = 13 dBm

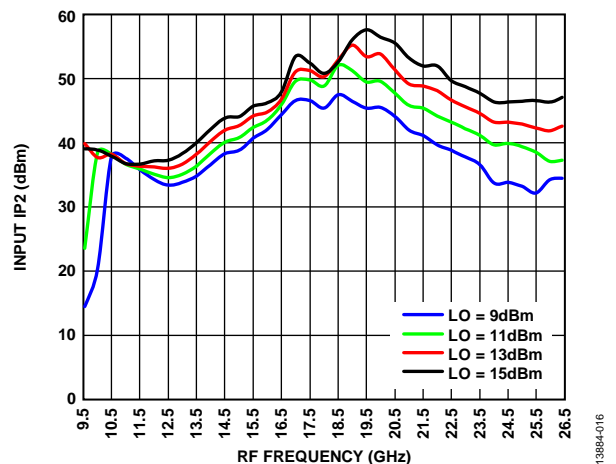

Figure 16. Input IP2 vs. RF Frequency at Various LO Power Levels, TA = 25°C

UPCONVERTER PERFORMANCE

Upconverter performance at input intermediate frequency ( $IF_{IN}$ ) = 1000 MHz, upper sideband (low-side LO).

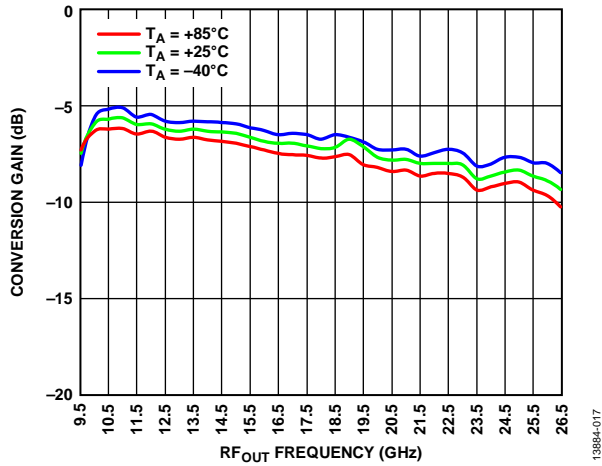

Figure 17. Conversion Gain vs.  $RF_{OUT}$  Frequency at Various Temperatures, LO = 13 dBm

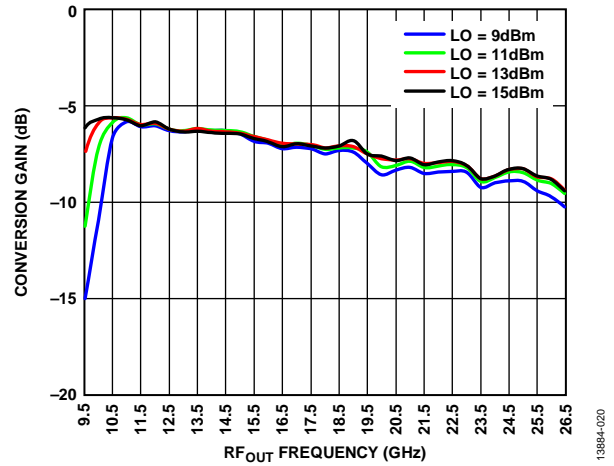

Figure 20. Conversion Gain vs.  $RF_{OUT}$  Frequency at Various LO Power Levels,  $T_A = 25^\circ\text{C}$

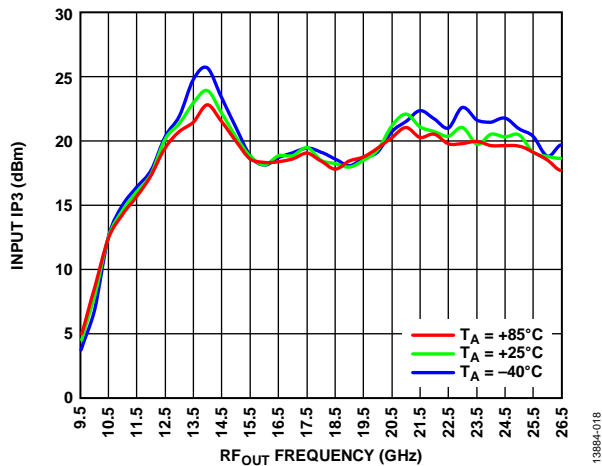

Figure 18. Input IP3 vs.  $RF_{OUT}$  Frequency at Various Temperatures, LO = 13 dBm

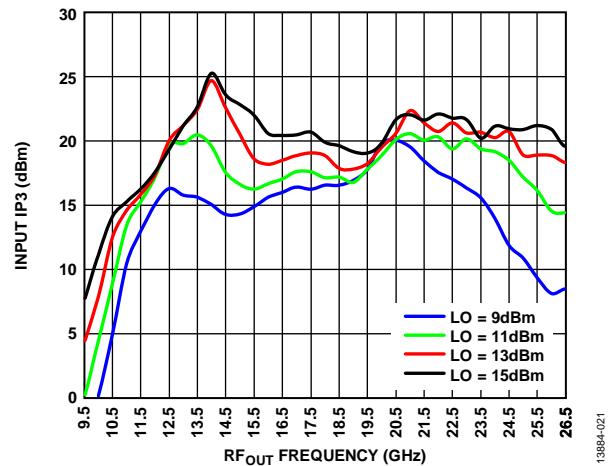

Figure 21. Input IP3 vs.  $RF_{OUT}$  Frequency at Various LO Power Levels,  $T_A = 25^\circ\text{C}$

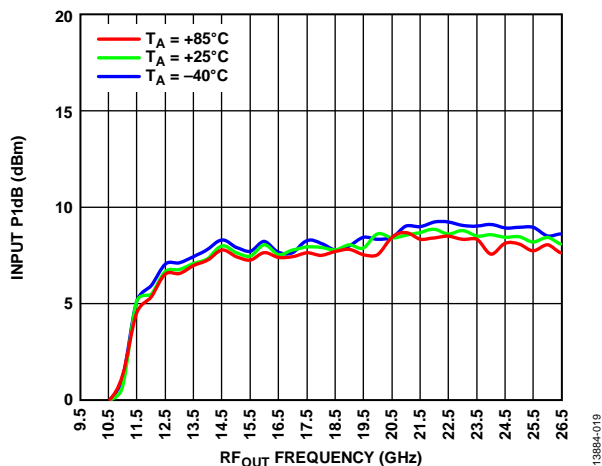

Figure 19. Input P1dB vs.  $RF_{OUT}$  Frequency at Various Temperatures, LO = 13 dBm

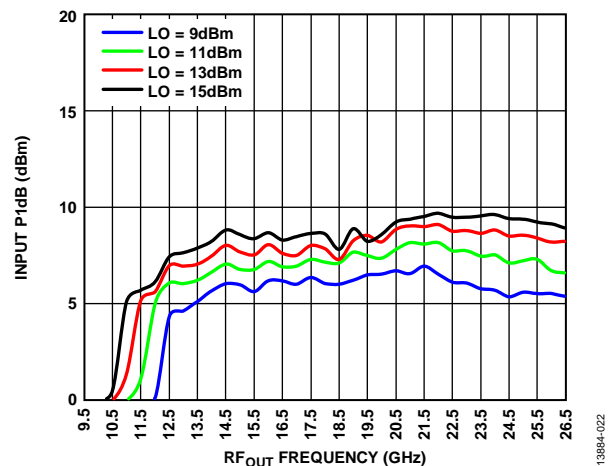

Figure 22. Input P1dB vs.  $RF_{OUT}$  Frequency at Various LO Power Levels,  $T_A = 25^\circ\text{C}$

**ISOLATION AND RETURN LOSS**

Downconverter performance at IF = 1000 MHz, upper sideband.

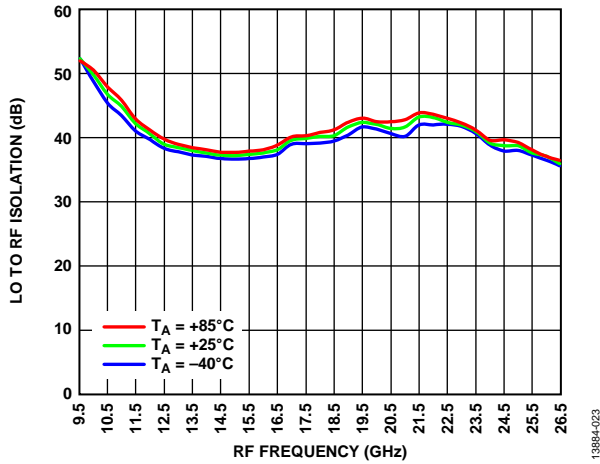

Figure 23. LO to RF Isolation vs. RF Frequency at Various Temperatures, LO = 13 dBm

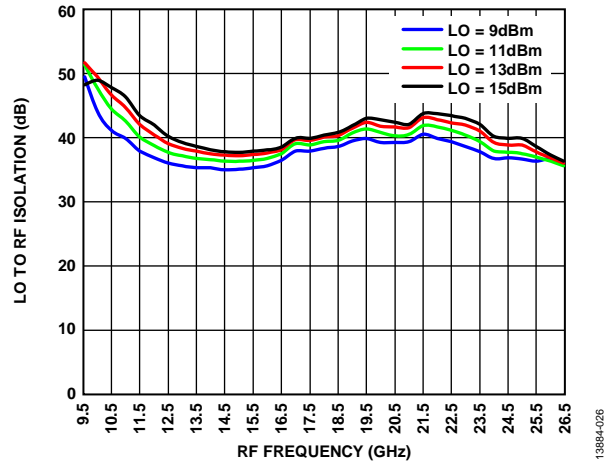

Figure 26. LO to RF Isolation vs. RF Frequency at Various LO Power Levels, TA = 25°C

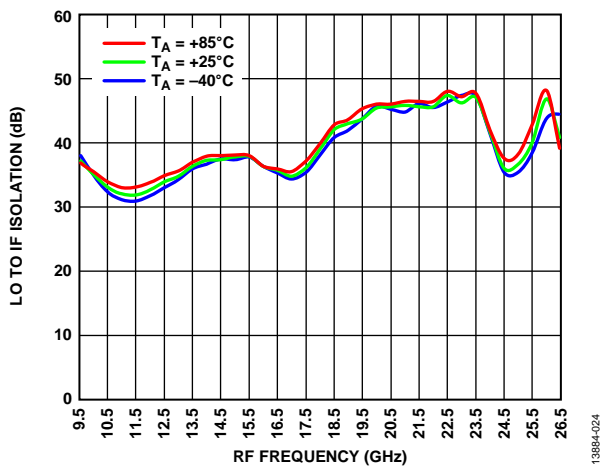

Figure 24. LO to IF Isolation vs. RF Frequency at Various Temperatures, LO = 13 dBm

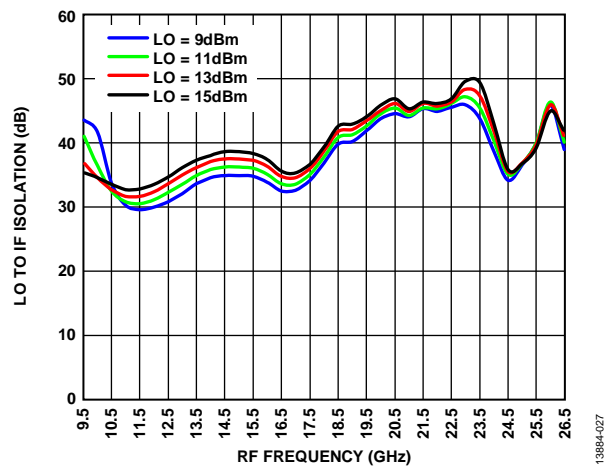

Figure 27. LO to IF Isolation vs. RF Frequency at Various LO Power Levels, TA = 25°C

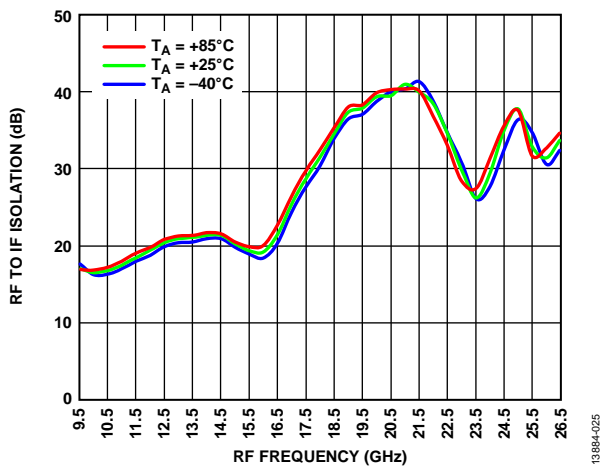

Figure 25. RF to IF Isolation vs. RF Frequency at Various Temperatures, LO = 13 dBm

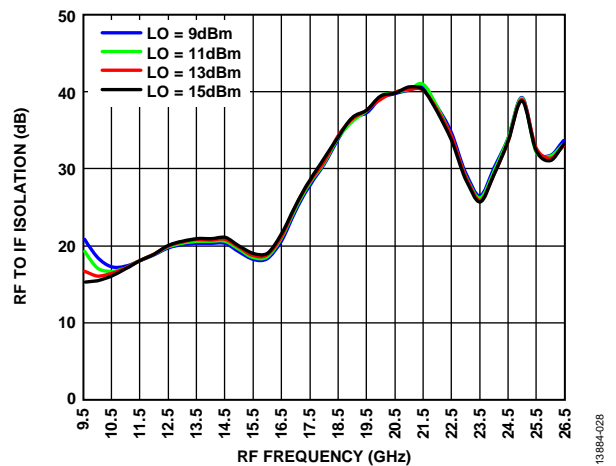

Figure 28. RF to IF Isolation vs. RF Frequency at Various LO Power Levels, LO = 17 GHz, TA = 25°C



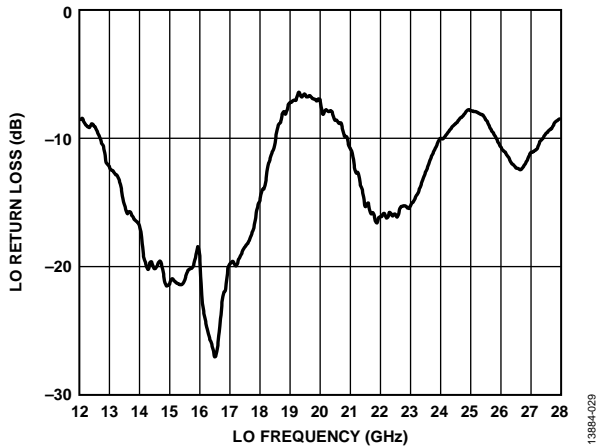

Figure 29. LO Return Loss vs. LO Frequency,  $T_A = 25^\circ\text{C}$ , LO = 13 dBm

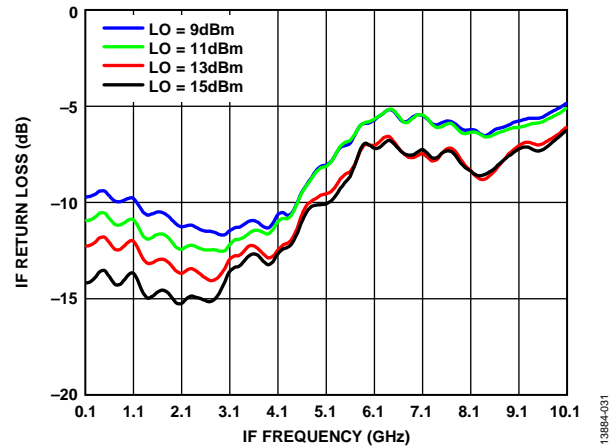

Figure 31. IF Return Loss vs. IF Frequency at Various LO Powers, LO = 17 GHz,  $T_A = 25^\circ\text{C}$

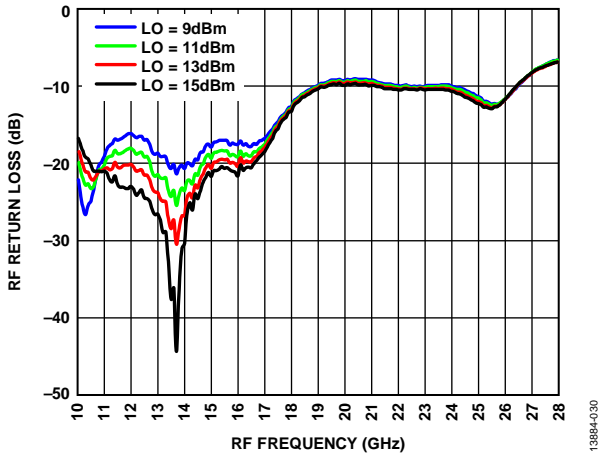

Figure 30. RF Return Loss vs. RF Frequency at Various LO Powers,  $T_A = 25^\circ\text{C}$

**IF BANDWIDTH—DOWNCONVERTER**

Upper sideband, RF = 20 GHz.

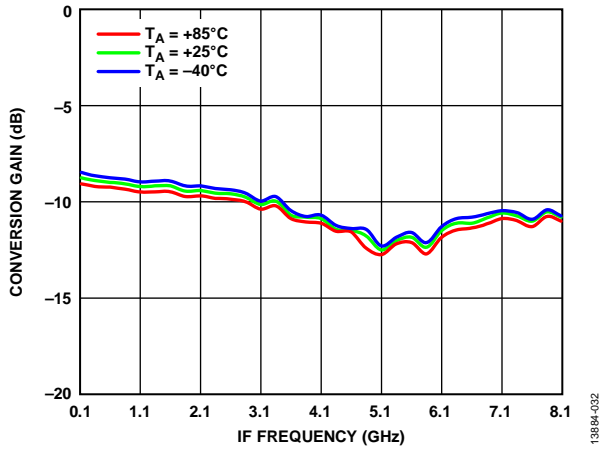

Figure 32. Conversion Gain vs. IF Frequency at Various Temperatures, LO = 13 dBm

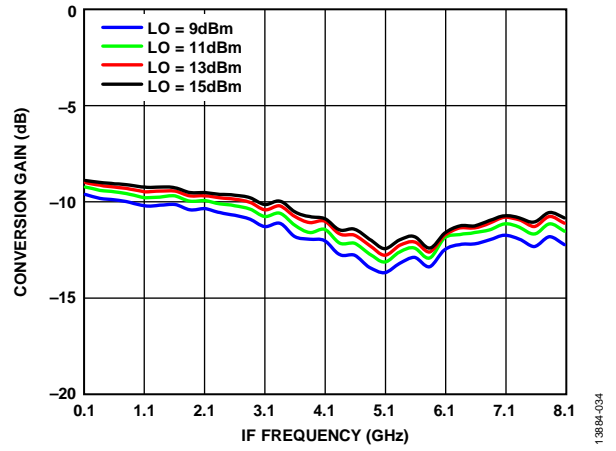

Figure 34. Conversion Gain vs. IF Frequency at Various LO Power Levels,  $T_A = 25^\circ\text{C}$

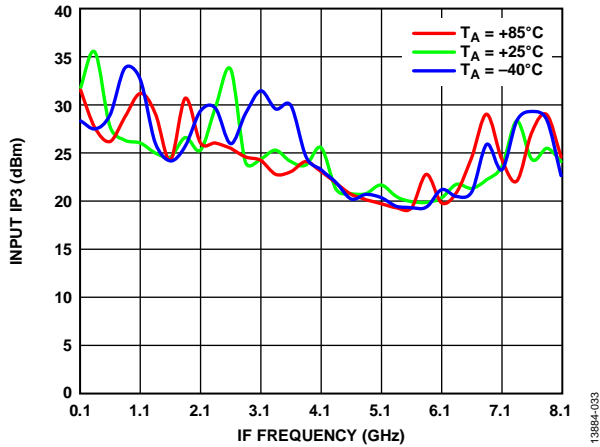

Figure 33. Input IP3 vs. IF Frequency at Various Temperatures, LO = 13 dBm

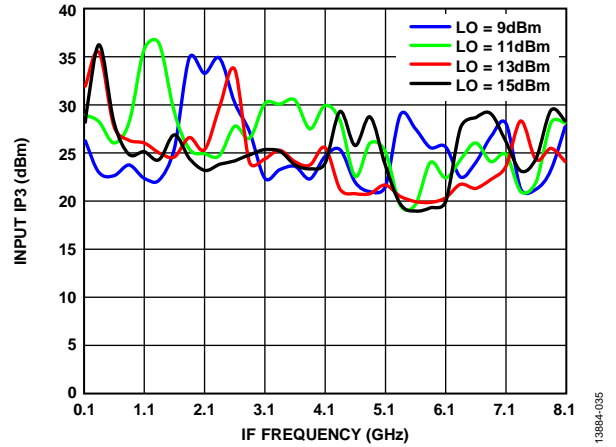

Figure 35. Input IP3 vs. IF Frequency at Various LO Power Levels,  $T_A = 25^\circ\text{C}$

**IF BANDWIDTH—UPCONVERTER**

Upper sideband,  $RF_{OUT} = 20$  GHz.

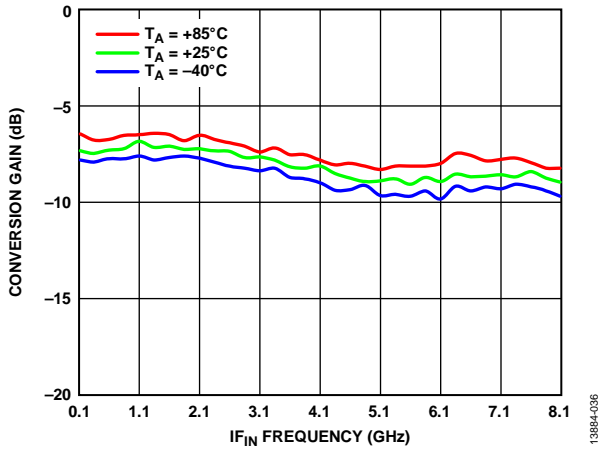

Figure 36. Conversion Gain vs.  $IF_{IN}$  Frequency at Various Temperatures,  $LO = 13$  dBm

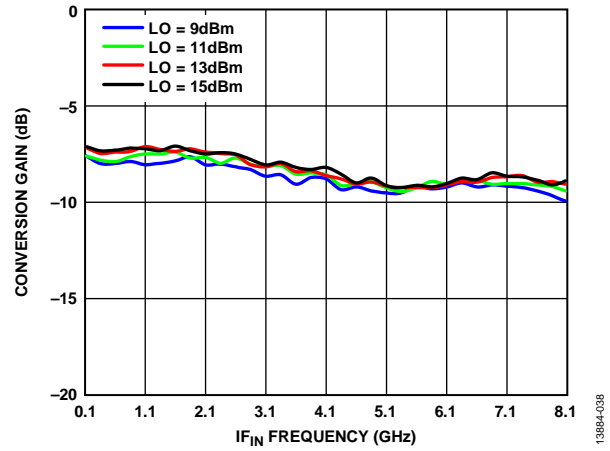

Figure 38. Conversion Gain vs.  $IF_{IN}$  Frequency at Various LO Power Levels,  $T_A = 25^\circ C$

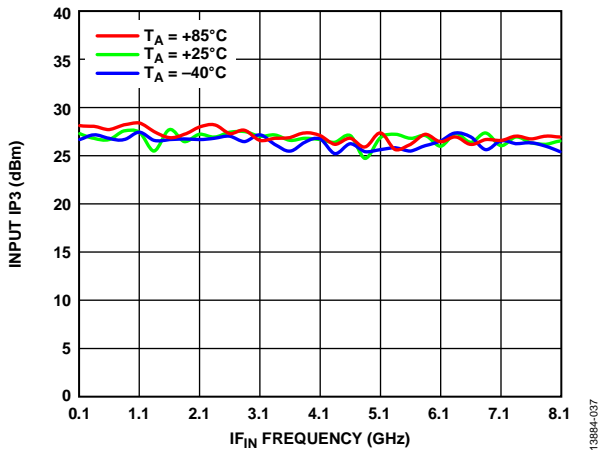

Figure 37. Input IP3 vs.  $IF_{IN}$  Frequency at Various Temperatures,  $LO = 13$  dBm

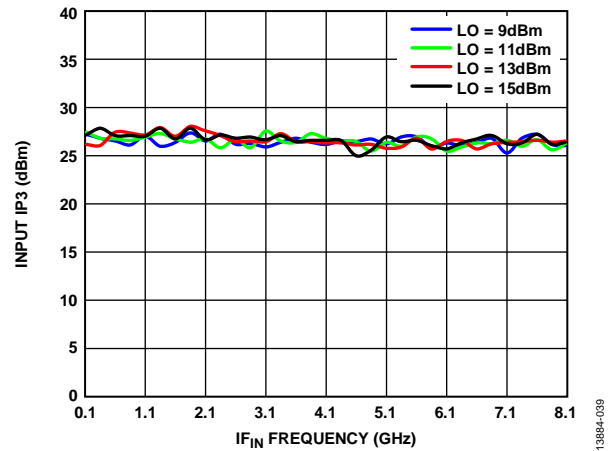

Figure 39. Input IP3 vs.  $IF_{IN}$  Frequency at Various LO Power Levels,  $T_A = 25^\circ C$

**SPURIOUS AND HARMONICS PERFORMANCE**

Mixer spurious products are measured in dBc from either the RF pin or IF pin output power level. N/A means not applicable.

**Downconverter  $M \times N$  Spurious Outputs**

Spur values are  $(M \times RF) - (N \times LO)$ .

RF = 18 GHz at -10 dBm, LO = 17 GHz at 13 dBm.

		N x LO				
		0	1	2	3	4
M x RF	0	N/A	7	19	N/A	N/A
	1	23	0	34	42	N/A
	2	67	71	66	71	68
	3	N/A	63	72	84	73
	4	N/A	N/A	64	74	77

**Upconverter  $M \times N$  Spurious Outputs**

Spur values are  $(M \times IF_{IN}) + (N \times LO)$ .

$IF_{IN}$  = 1000 MHz at -10 dBm, LO = 17 GHz at 13 dBm.

		N x LO				
		0	1	2	3	4
M x IF <sub>IN</sub>	-5	81	77	73	N/A	N/A
	-4	83	78	71	N/A	N/A
	-3	73	64	72	N/A	N/A
	-2	55	42	66	N/A	N/A
	-1	18	0	28	N/A	N/A
	0	0	9.5	17	N/A	N/A
	1	18	0	40	N/A	N/A
	2	55	45	67	N/A	N/A
	3	74	66	64	N/A	N/A
	4	81	74	66	N/A	N/A
	5	80	74	68	N/A	N/A

## THEORY OF OPERATION

The HMC260ALC3B is a general-purpose, double balanced mixer that can be used as an upconverter or a downconverter from 10 GHz to 26 GHz.

When used as a downconverter, the HMC260ALC3B downconverts RF between 10 GHz and 26 GHz to IF between dc and 8 GHz.

When used as an upconverter, the mixer upconverts IF between dc and 8 GHz to RF between 10 GHz and 26 GHz.

The mixer performs well with LO drives of 9 dBm or greater, and it provides LO to RF and LO to IF suppression due to optimized balun structures. The ceramic LCC package eliminates the need for wire bonding and is compatible with high volume, surface-mount manufacturing techniques.

# APPLICATIONS INFORMATION

## TYPICAL APPLICATION CIRCUIT

Figure 40 shows the typical application circuit for the HMC260ALC3B. The HMC260ALC3B is a passive device and does not require any external components. The LO and RF pins are internally ac-coupled. The IF pin is internally dc-coupled. When IF operation to dc is not required, use of an external series capacitor of a value chosen to pass the necessary IF frequency range is recommended. When IF operation to dc is required, do not exceed the IF source and sink current rating specified in the Absolute Maximum Ratings section.

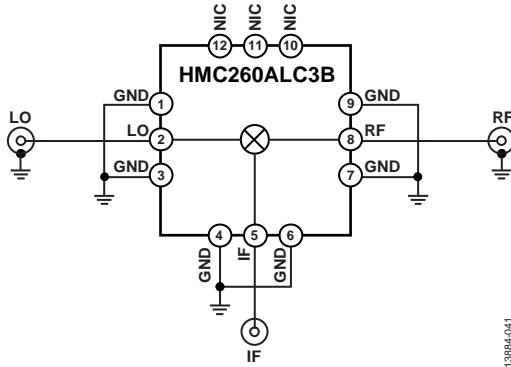

Figure 40. Typical Application Circuit

## EVALUATION PCB INFORMATION

Use RF circuit design techniques for the circuit board. Ensure that signal lines have 50 Ω impedance. Connect the package ground leads and the exposed pad directly to the ground plane (see Figure 41). Use a sufficient number of via holes to connect the top and bottom ground planes. The evaluation circuit board shown in Figure 41 is available from Analog Devices, Inc., upon request.

Table 5. Bill of Materials

Item	Description
J1, J2	PCB mount SRI 2.92 mm connectors
J3	PCB mount Johnson SMA connector
U1	HMC260ALC3B
PCB <sup>1</sup>	117611 evaluation board on Rogers 4350

<sup>1</sup> 117611 is the raw bare PCB identifier. Reference 109728 when ordering the complete evaluation PCB.

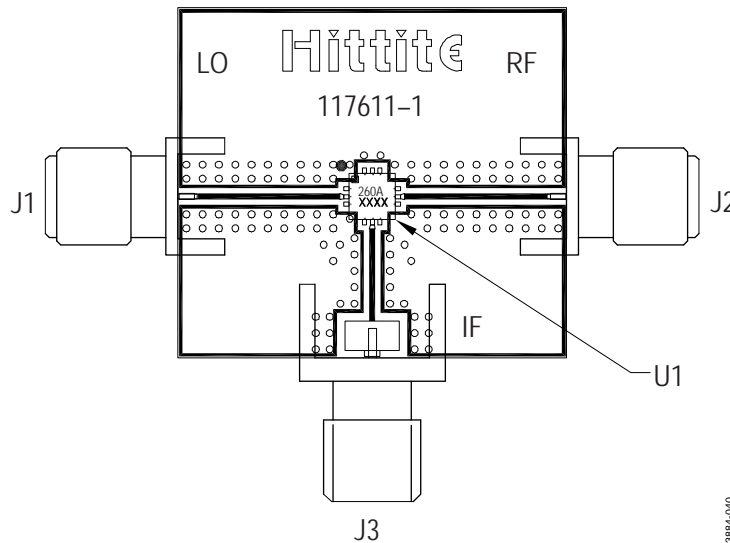

Figure 41. Evaluation PCB Top Layer

OUTLINE DIMENSIONS

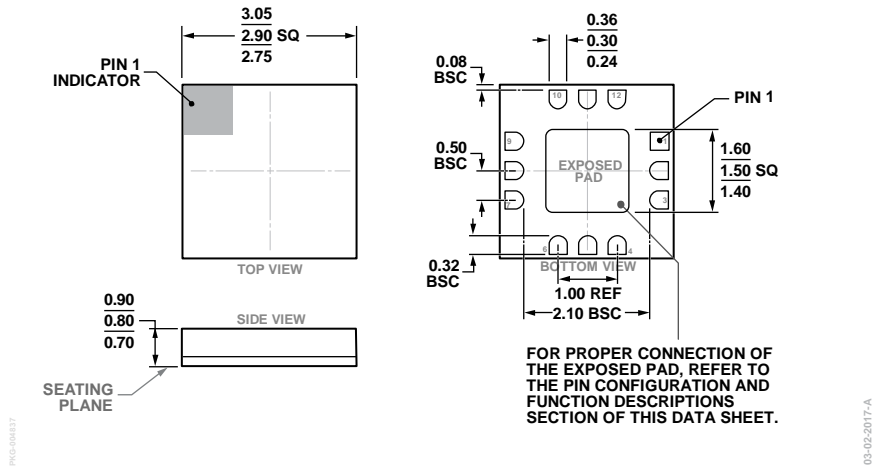

Figure 42. 12-Terminal Ceramic Leadless Chip Carrier (LCC)  
(E-12-4)  
Dimensions shown in millimeters

ORDERING GUIDE

Model <sup>1</sup>	Temperature Range	MSL Rating <sup>2</sup>	Package Description	Package Option
HMC260ALC3B	-40°C to +85°C	MSL3	12-Terminal LCC	E-12-4
HMC260ALC3BTR	-40°C to +85°C	MSL3	12-Terminal LCC	E-12-4
HMC260ALC3BTR-R5	-40°C to +85°C	MSL3	12-Terminal LCC	E-12-4
EV1HMC260ALC3B			Evaluation PCB	

<sup>1</sup> All models are RoHS compliant devices.

<sup>2</sup> The peak reflow temperature is 260°C. See Table 2 in the Absolute Maximum Ratings section.