

TABLE OF CONTENTS

Features	1
Applications.....	1
Functional Block Diagram	1
General Description	1
Revision History	2
Specifications.....	3
Typical Scattering Parameters.....	4
Absolute Maximum Ratings.....	5
Thermal Resistance	5
ESD Caution.....	5
Pin Configuration and Function Descriptions.....	6
Typical Performance Characteristics	7

REVISION HISTORY

10/13—Rev. A to Rev. B

Changed 1805 MHz to 2110 MHz	Throughout
Changes to Figure 27	10
Changes to Figure 34 and Table 6.....	12
Changes to Figure 35.....	13
Changes to Matching Procedures Section.....	14
Added Optimizing OP1dB Section, Table 10, Table 11, Table 12, and Figure 39; Renumbered Sequentially.....	15
Changes to Evaluation Board Section	16
Updated Outline Dimensions	18
Changes to Ordering Guide	18

6/12—Rev. 0 to Rev. A

Changes to Features Section and General Description Section.....	1
Added Application Section and Figure 2; Renumbered Sequentially	1
Changes to Specifications Section	3
Deleted θ_{JC} (Junction to Paddle) Parameter, Table 3.....	5

High Temperature and 3.3 V Operation	11
Applications Information	12
Basic Layout Connections.....	12
Soldering Information and Recommended PCB Land Pattern.....	13
Matching Procedure.....	14
Optimizing OP1dB	15
W-CDMA ACPR Performance	15
Evaluation Board	16
Outline Dimensions	18
Ordering Guide	18

Changes to Operating Temperature Range Parameter,

Table 3	5
Added Thermal Resistance Section and Table 4; Renumbered Sequentially	5
Added EPAD Notation to Figure 3	6
Added Figure 27	10
Added High Temperature and 3.3 V Operation Section and Figure 28 to Figure 33	11
Added Applications Information Section and Figure 35	12
Changes to Soldering Information and Recommended PCB Land Pattern	12
Changed -82 dBc to -80 dBc in W-CDMA ACPR Performance Section.....	14
Added Figure 39	14
Updated Outline Dimensions	17

2/08—Revision 0: Initial Version

SPECIFICATIONS

T_A = 25°C, unless otherwise noted.

Table 1.

Parameter	Test Conditions/Comments	3.3 V			5 V			Unit
		Min	Typ	Max	Min	Typ	Max	
OVERALL FUNCTION								
Frequency Range		400		2700	400		2700	MHz
FREQUENCY = 880 MHz								
Gain ¹			15.6		16.3	16.9	17.5	dB
vs. Frequency	±50 MHz		±0.2			±0.3		dB
vs. Temperature	−40°C ≤ T _A ≤ +85°C		±0.6			±0.6		dB
vs. Supply	3.2 V to 3.4 V, 4.75 V to 5.25 V		±0.2			±0.1		dB
Output 1 dB Compression Point			21.5			25.4		dBm
Output Third-Order Intercept	Δf = 1 MHz, P _{OUT} = 10 dBm per tone		34			45		dBm
Noise Figure			3.2			4.1		dB
FREQUENCY = 2140 MHz								
Gain ¹			12.2		12.4	13.2	14.0	dB
vs. Frequency	±50 MHz		±0.3			±0.33		dB
vs. Temperature	−40°C ≤ T _A ≤ +85°C		±0.7			±0.8		dB
vs. Supply	3.2 V to 3.4 V, 4.75 V to 5.25 V		±0.15			±0.06		dB
Output 1 dB Compression Point			22.6			25.7		dBm
Output Third-Order Intercept	Δf = 1 MHz, P _{OUT} = 10 dBm per tone		32			42		dBm
Noise Figure			3.7			4.4		dB
FREQUENCY = 2600 MHz								
Gain ¹			10.7		11.5	12.5	13.4	dB
vs. Frequency	±100 MHz		±0.2			±0.6		dB
vs. Temperature	−40°C ≤ T _A ≤ +85°C		±0.6			±1.1		dB
vs. Supply	3.2 V to 3.4 V, 4.75 V to 5.25 V		±0.2			±0.1		dB
Output 1 dB Compression Point			25.7			27.4		dBm
Output Third-Order Intercept	Δf = 1 MHz, P _{OUT} = 10 dBm per tone		29			37		dBm
Noise Figure			4.1			5.1		dB
POWER INTERFACE	Pin RF _{OUT}							
Supply Voltage			3.3		4.5	5	5.5	V
Supply Current			44			104	124	mA
vs. Temperature	−40°C ≤ T _A ≤ +85°C		±5.0			±6.0		mA
Power Dissipation	VSUP = 3.3 V, VSUP = 5 V		145			520		mW

¹ Guaranteed maximum and minimum specified limits on this parameter are based on six sigma calculations.

TYPICAL SCATTERING PARAMETERS

VSUP = 5 V and T_A = 25°C; the effects of the test fixture have been de-embedded up to the pins of the device.

Table 2.

Freq (MHz)	S11		S21		S12		S22	
	Magnitude (dB)	Angle (°)	Magnitude (dB)	Angle (°)	Magnitude (dB)	Angle (°)	Magnitude (dB)	Angle (°)
400	-1.42	-179.88	+14.16	+134.74	-32.56	+13.47	-3.42	+176.22
500	-1.38	+175.04	+13.97	+126.21	-32.02	+8.58	-3.71	+175.38
550	-1.42	+173.05	+13.81	+122.24	-31.84	+6.81	-3.84	+175.10
600	-1.48	+171.25	+13.66	+118.41	-31.70	+5.25	-3.96	+174.89
650	-1.54	+169.59	+13.49	+114.71	-31.56	+3.85	-4.08	+174.74
700	-1.62	+168.11	+13.32	+111.12	-31.43	+2.63	-4.19	+174.71
750	-1.70	+166.66	+13.17	+107.64	-31.29	+1.35	-4.30	+174.74
800	-1.80	+165.36	+13.05	+104.27	-31.16	+0.20	-4.41	+174.89
850	-1.90	+163.99	+12.94	+100.86	-31.01	-0.95	-4.52	+175.10
900	-2.01	+162.65	+12.84	+97.48	-30.85	-2.23	-4.62	+175.37
950	-2.13	+161.32	+12.73	+94.09	-30.69	-3.43	-4.71	+175.78
1000	-2.27	+159.98	+12.65	+90.72	-30.52	-4.80	-4.81	+176.29
1050	-2.43	+158.61	+12.62	+87.34	-30.32	-6.24	-4.89	+176.85
1100	-2.63	+157.11	+12.59	+83.90	-30.15	-7.92	-4.98	+177.52
1150	-2.84	+155.60	+12.56	+80.41	-29.95	-9.61	-5.06	+178.29
1200	-3.09	+153.91	+12.55	+76.75	-29.74	-11.56	-5.12	+179.17
1250	-3.39	+152.08	+12.56	+73.03	-29.54	-13.63	-5.18	-179.85
1300	-3.73	+150.14	+12.57	+69.24	-29.33	-15.87	-5.25	-178.72
1350	-4.13	+147.98	+12.61	+65.23	-29.12	-18.39	-5.28	-177.52
1400	-4.59	+145.57	+12.66	+61.05	-28.91	-21.17	-5.29	-176.26
1450	-5.13	+143.05	+12.72	+56.75	-28.69	-24.17	-5.27	-174.93
1500	-5.76	+140.31	+12.79	+52.20	-28.48	-27.48	-5.19	-173.52
1550	-6.48	+137.18	+12.83	+47.46	-28.28	-31.05	-5.12	-172.60
1600	-7.36	+133.46	+12.89	+42.49	-28.10	-34.99	-5.06	-171.45
1650	-8.45	+129.65	+12.93	+37.41	-27.95	-39.05	-4.94	-170.38
1700	-9.74	+125.36	+12.98	+32.12	-27.81	-43.45	-4.80	-169.52
1750	-11.32	+120.71	+12.99	+26.74	-27.70	-48.12	-4.65	-168.95
1800	-13.34	+115.47	+12.99	+21.16	-27.61	-53.06	-4.47	-168.68
1850	-16.00	+109.24	+12.97	+15.43	-27.56	-58.23	-4.30	-168.76
1900	-19.89	+100.84	+12.93	+9.57	-27.55	-63.67	-4.14	-169.26
1950	-26.68	+83.39	+12.86	+3.65	-27.58	-69.38	-3.99	-170.11
2000	-33.34	-26.40	+12.76	-2.46	-27.65	-75.33	-3.86	-171.37
2050	-23.21	-71.32	+12.64	-8.60	-27.75	-81.44	-3.74	-172.97
2100	-18.39	-83.50	+12.49	-14.83	-27.89	-87.92	-3.65	-175.01
2150	-15.39	-92.08	+12.31	-21.09	-28.07	-94.55	-3.58	-177.37
2200	-13.26	-100.04	+12.11	-27.46	-28.29	-101.56	-3.54	+179.90
2250	-11.63	-107.86	+11.88	-33.90	-28.54	-108.80	-3.50	+176.83
2300	-10.31	-115.84	+11.62	-40.49	-28.82	-116.46	-3.47	+173.43
2350	-9.20	-123.94	+11.33	-47.09	-29.15	-124.41	-3.44	+169.75
2400	-8.23	-132.24	+11.01	-53.81	-29.50	-132.81	-3.42	+165.83
2450	-7.38	-140.88	+10.64	-60.65	-29.89	-141.70	-3.40	+161.63
2500	-6.61	-149.66	+10.24	-67.57	-30.31	-150.89	-3.36	+157.29
2550	-5.89	-158.59	+9.78	-74.53	-30.76	-160.57	-3.31	+152.82
2600	-5.23	-167.51	+9.27	-81.60	-31.23	-170.68	-3.24	+148.32
2650	-4.62	-176.26	+8.70	-88.50	-31.73	+178.90	-3.17	+143.81
2700	-4.05	+175.18	+8.07	-95.43	-32.22	+168.34	-3.09	+139.40

ABSOLUTE MAXIMUM RATINGS

Table 3.

Parameter	Rating
Supply Voltage, VSUP	6.5 V
Input Power (50 Ω Impedance)	20 dBm
Internal Power Dissipation (Paddle Soldered)	683 mW
Maximum Junction Temperature	150°C
Operating Temperature Range	-40°C to +105°C
Storage Temperature Range	-65°C to +150°C

Stresses above those listed under Absolute Maximum Ratings may cause permanent damage to the device. This is a stress rating only; functional operation of the device at these or any other conditions above those indicated in the operational section of this specification is not implied. Exposure to absolute maximum rating conditions for extended periods may affect device reliability.

THERMAL RESISTANCE

Table 4 lists the junction-to-air thermal resistance (θ_{JA}) and the junction-to-paddle thermal resistance (θ_{JC}) for the ADL5320.

Table 4. Thermal Resistance

Package Type	θ_{JA} ¹	θ_{JC} ²	Unit
3-Lead SOT-89	35	11	°C/W

¹ Measured on Analog Devices, Inc., evaluation board. For more information about board layout, see the Soldering Information and Recommended PCB Land Pattern section.

² Based on simulation with JEDEC standard JESD51.

ESD CAUTION



ESD (electrostatic discharge) sensitive device.

Charged devices and circuit boards can discharge without detection. Although this product features patented or proprietary protection circuitry, damage may occur on devices subjected to high energy ESD. Therefore, proper ESD precautions should be taken to avoid performance degradation or loss of functionality.

PIN CONFIGURATION AND FUNCTION DESCRIPTIONS

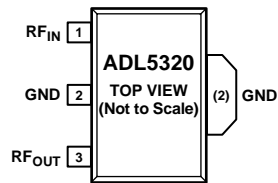

NOTES

1. THE EXPOSED PAD IS INTERNALLY CONNECTED TO GND. SOLDER TO A LOW IMPEDANCE GROUND PLANE.

05944-002

Figure 3. Pin Configuration

Table 5. Pin Function Descriptions

Pin No.	Mnemonic	Description
1	RF _{IN}	RF Input. Requires a dc blocking capacitor.
2	GND	Ground. Connect to a low impedance ground plane.
3	RF _{OUT}	RF Output and Supply Voltage. DC bias is provided to this pin through an inductor that is connected to the external power supply. RF path requires a dc blocking capacitor.
	Exposed Paddle	Expose Paddle. Internally connected to GND. Solder to a low impedance ground plane.

TYPICAL PERFORMANCE CHARACTERISTICS

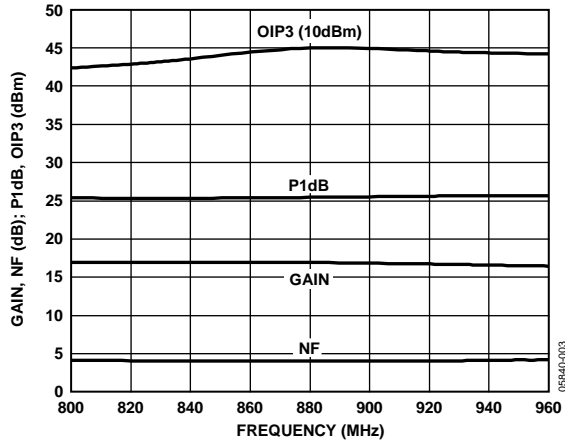

Figure 4. Gain, P1dB, OIP3, and Noise Figure vs. Frequency, 800 MHz to 960 MHz

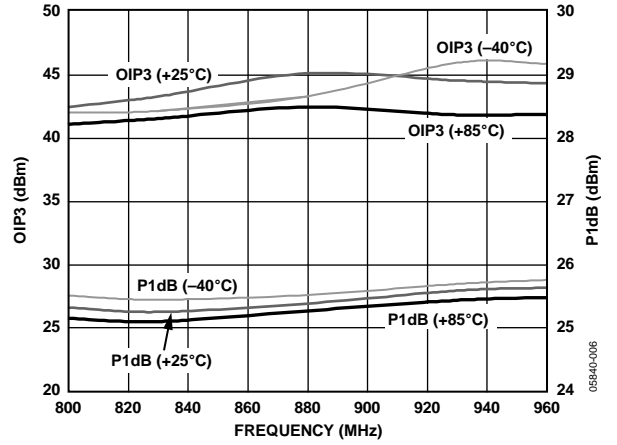

Figure 7. OIP3 and P1dB vs. Frequency and Temperature, 800 MHz to 960 MHz

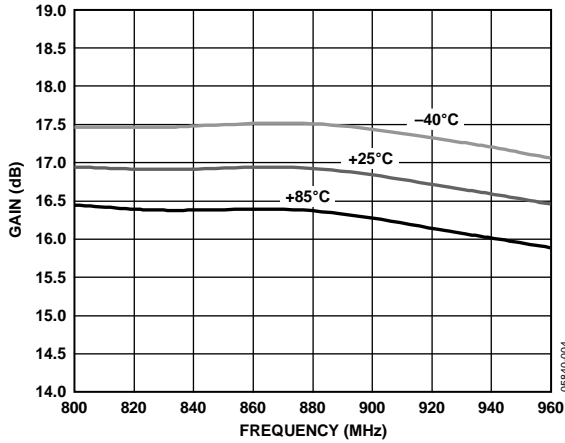

Figure 5. Gain vs. Frequency and Temperature, 800 MHz to 960 MHz

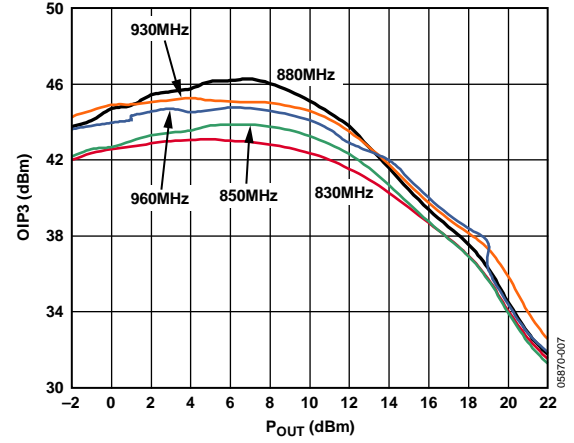

Figure 8. OIP3 vs. P_{OUT} and Frequency, 800 MHz to 960 MHz

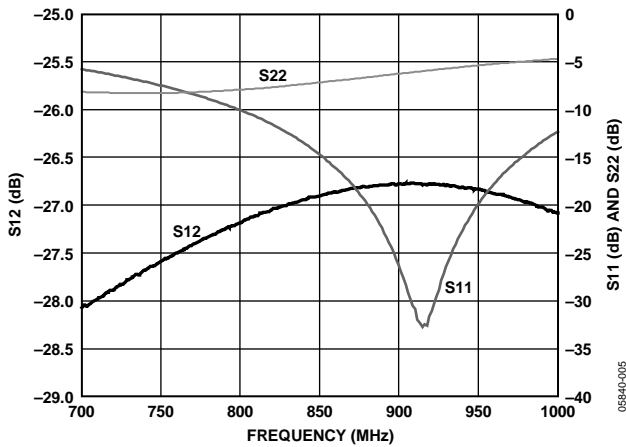

Figure 6. Input Return Loss (S11), Output Return Loss (S22), and Reverse Isolation (S12) vs. Frequency, 800 MHz to 960 MHz

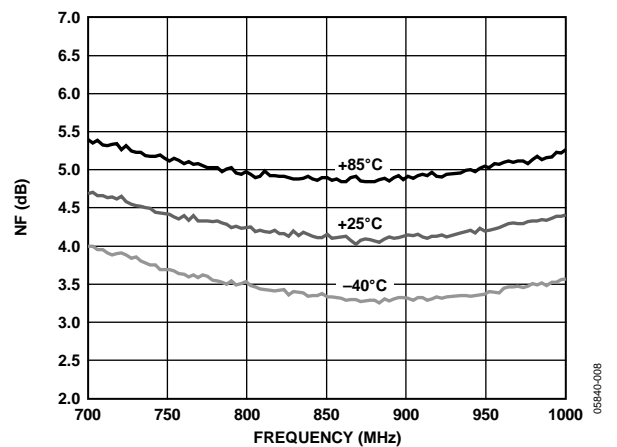

Figure 9. Noise Figure vs. Frequency and Temperature, 800 MHz to 960 MHz

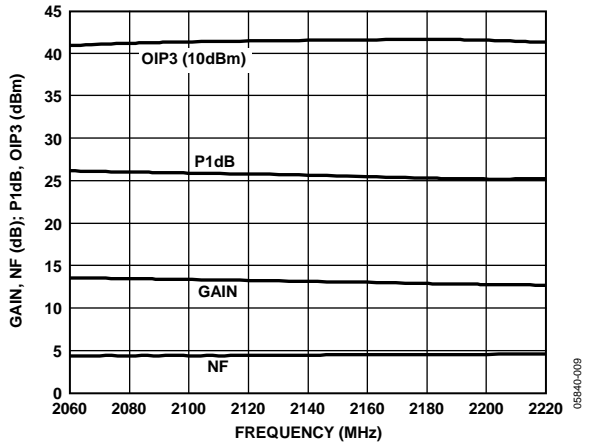

Figure 10. Gain, P1dB, OIP3, and Noise Figure vs. Frequency, 2060 MHz to 2200 MHz

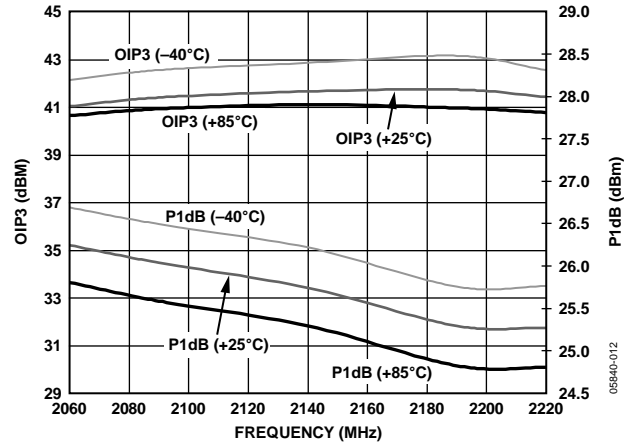

Figure 13. OIP3 and P1dB vs. Frequency and Temperature, 2060 MHz to 2200 MHz

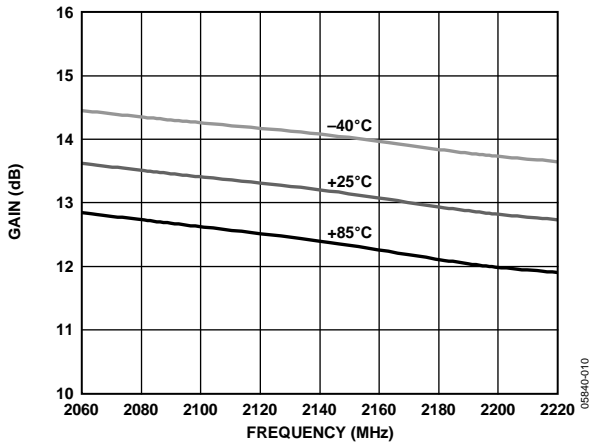

Figure 11. Gain vs. Frequency and Temperature, 2060 MHz to 2200 MHz

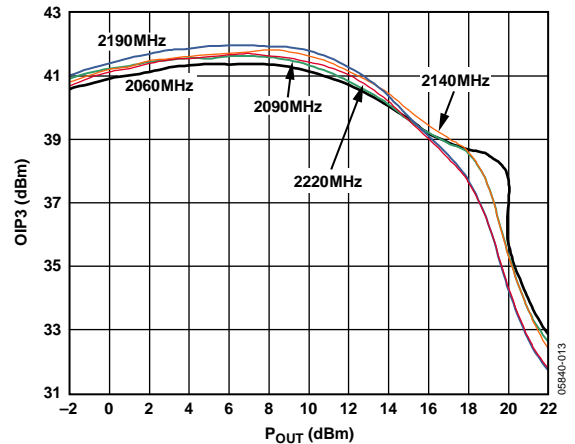

Figure 14. OIP3 vs. POUT and Frequency, 2060 MHz to 2200 MHz

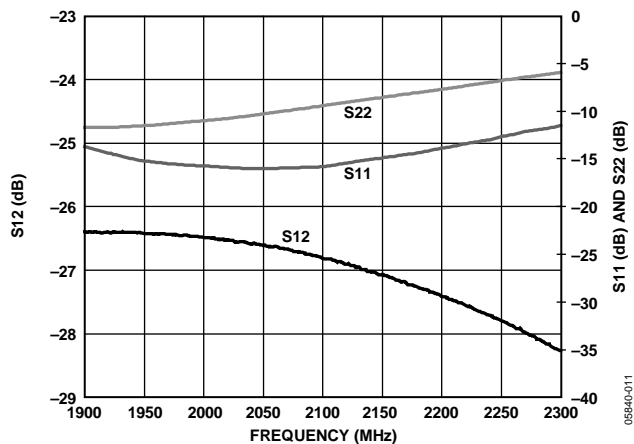

Figure 12. Input Return Loss (S11), Output Return Loss (S22), and Reverse Isolation (S12) vs. Frequency, 2060 MHz to 2200 MHz

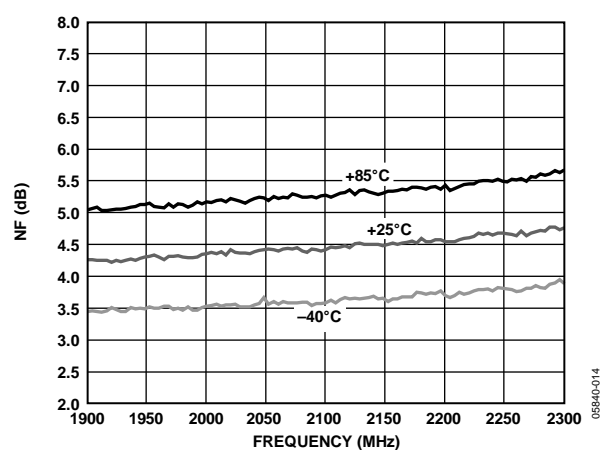

Figure 15. Noise Figure vs. Frequency and Temperature, 2060 MHz to 2200 MHz

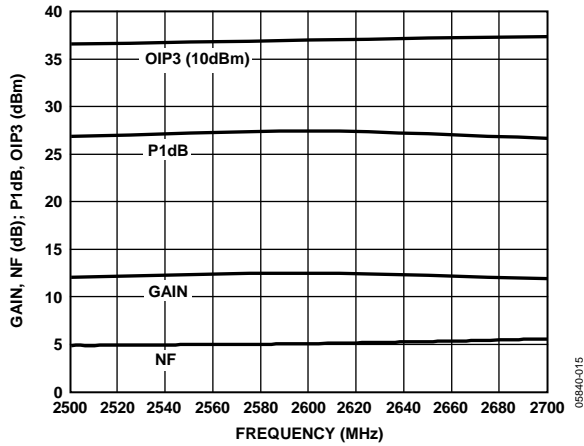

Figure 16. Gain, P1dB, OIP3, and Noise Figure vs. Frequency, 2500 MHz to 2700 MHz

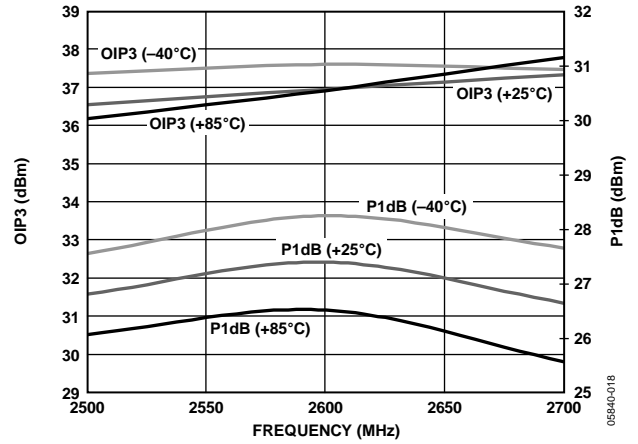

Figure 19. OIP3 and P1dB vs. Frequency and Temperature, 2500 MHz to 2700 MHz

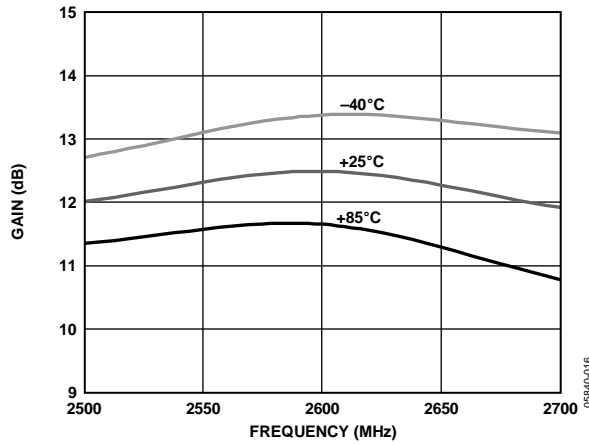

Figure 17. Gain vs. Frequency and Temperature, 2500 MHz to 2700 MHz

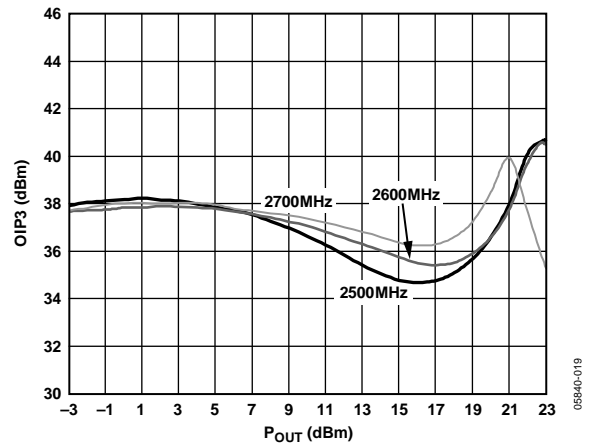

Figure 20. OIP3 vs. P_{OUT} and Frequency, 2500 MHz to 2700 MHz

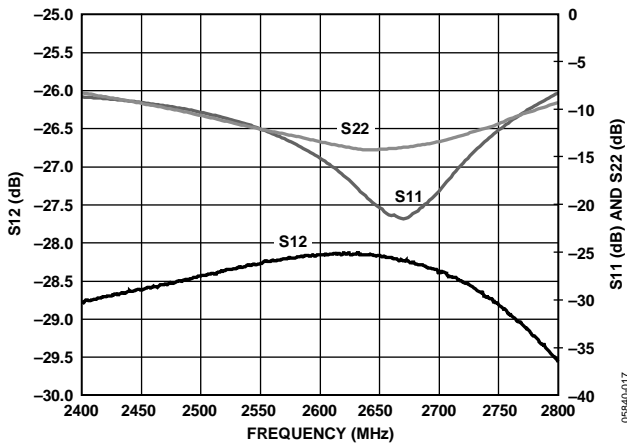

Figure 18. Input Return Loss (S11), Output Return Loss (S22), and Reverse Isolation (S12) vs. Frequency, 2500 MHz to 2700 MHz

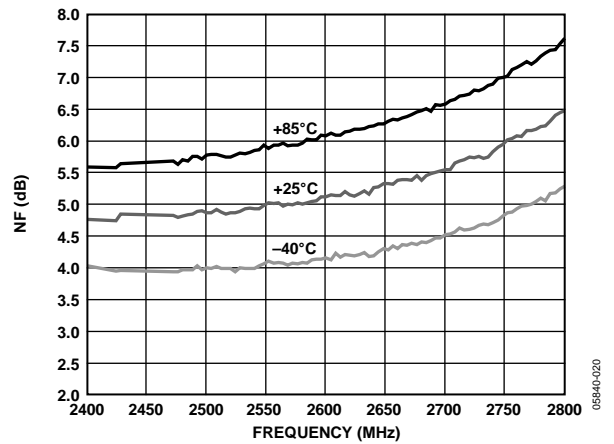

Figure 21. Noise Figure vs. Frequency and Temperature, 2500 MHz to 2700 MHz

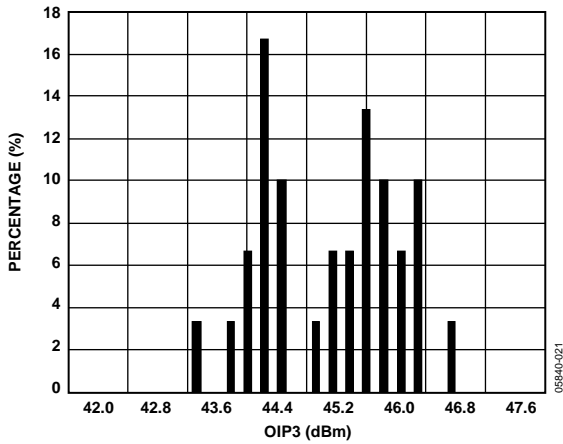

Figure 22. OIP3 Distribution at 880 MHz

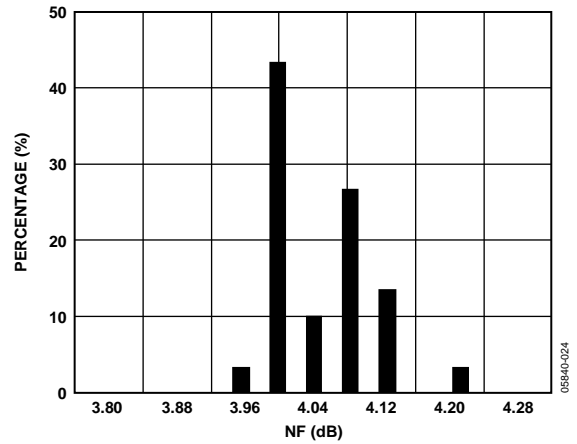

Figure 25. Noise Figure Distribution at 880 MHz

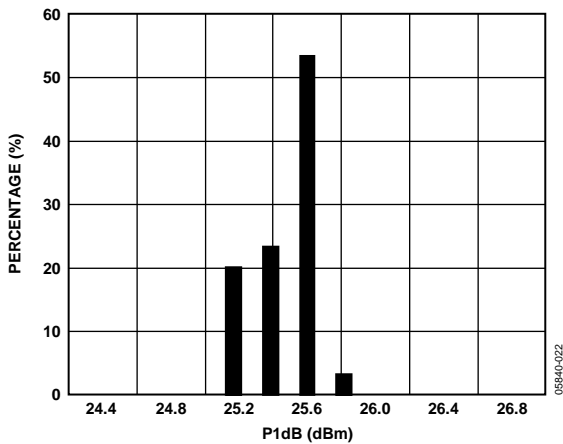

Figure 23. P1dB Distribution at 880 MHz

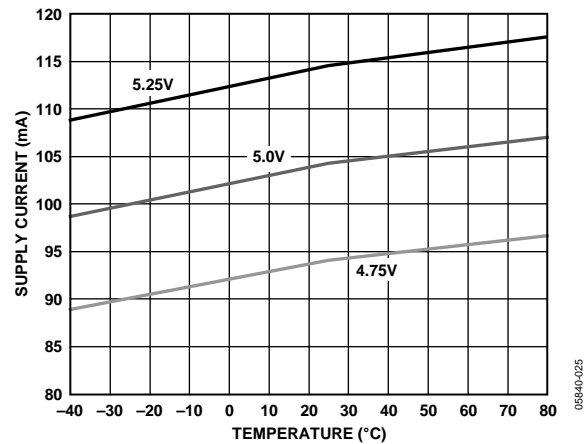

Figure 26. Supply Current vs. Supply Voltage and Temperature (Using 880 MHz Matching Components)

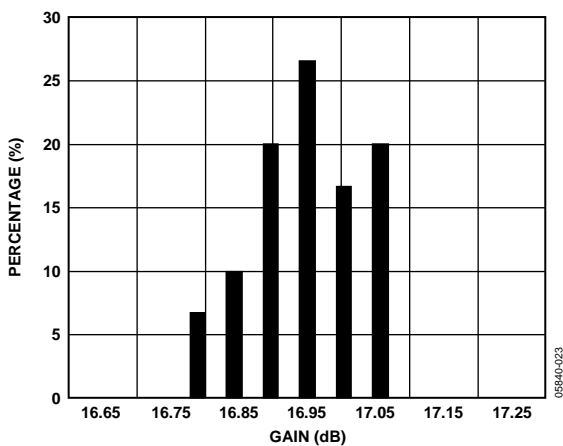

Figure 24. Gain Distribution at 880 MHz

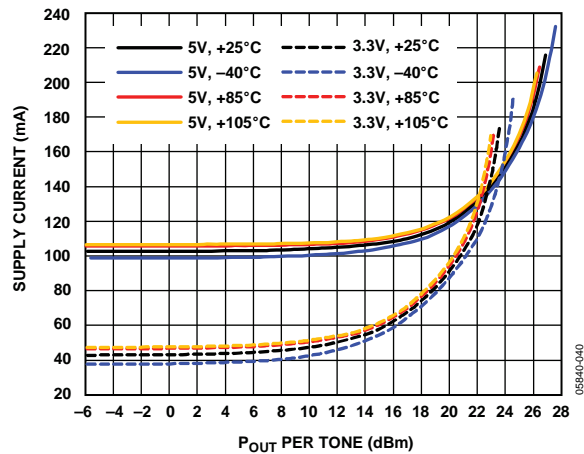

Figure 27. Supply Current vs. P_{OUT} and Temperature (2140 MHz Matching Components)

HIGH TEMPERATURE AND 3.3 V OPERATION

The ADL5320 has excellent performance at temperatures higher than 85°C. At 105°C, the gain and P1dB decrease by 0.2 dB, the OIP3 decreases by 0.4 dB, and the noise figure increases by 0.2 dB, compared with the data at 85°C. Figure 28, Figure 29, and Figure 30 show the performance at 105°C.

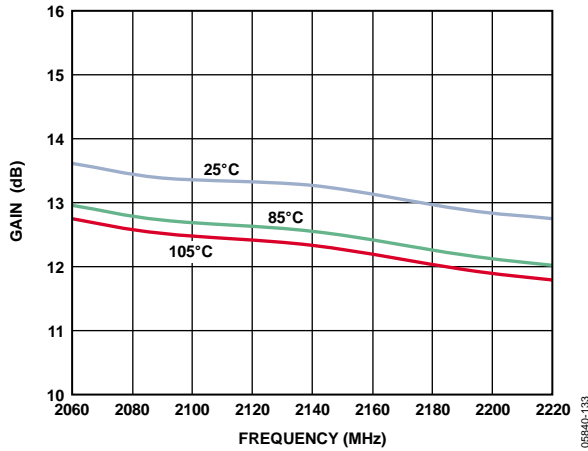

Figure 28. Gain vs. Frequency and Temperature, 5 V Supply, 2060 MHz to 2200 MHz

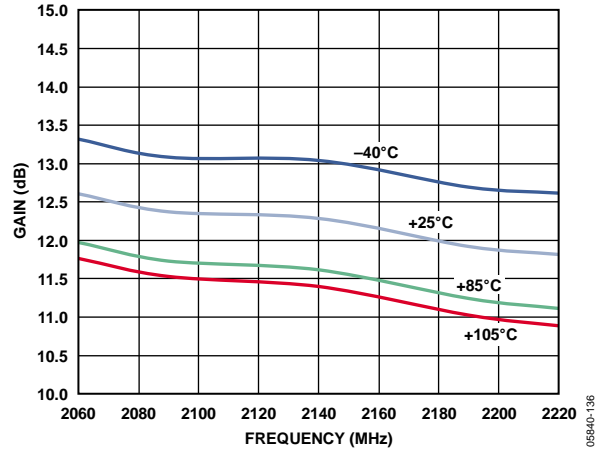

Figure 31. Gain vs. Frequency and Temperature, 3.3 V Supply, 2060 MHz to 2200 MHz

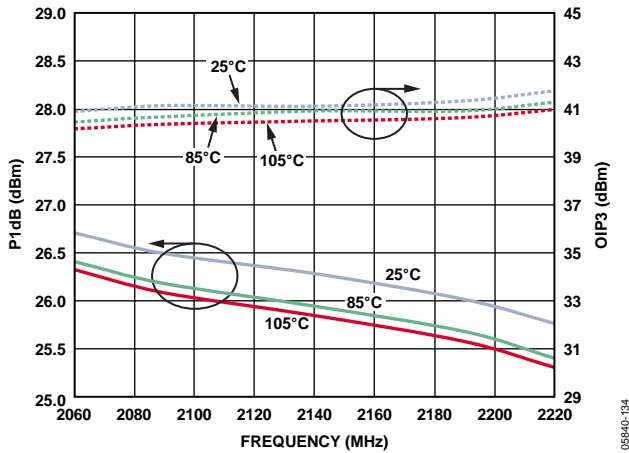

Figure 29. OIP3 and P1dB vs. Frequency and Temperature, 5 V Supply, 2060 MHz to 2200 MHz

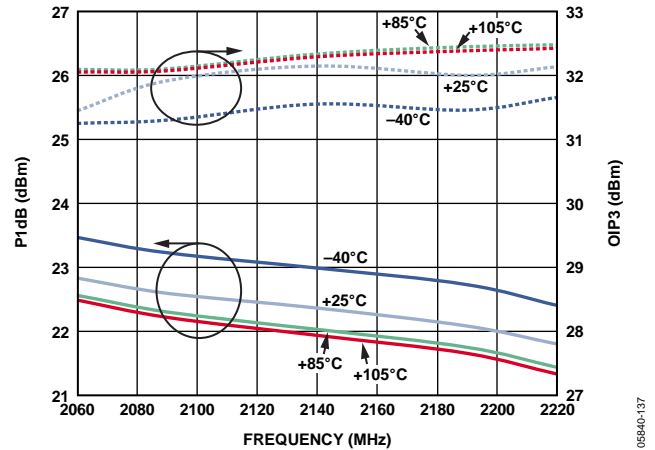

Figure 32. OIP3 and P1dB vs. Frequency and Temperature, 3.3 V Supply, 2060 MHz to 2200 MHz

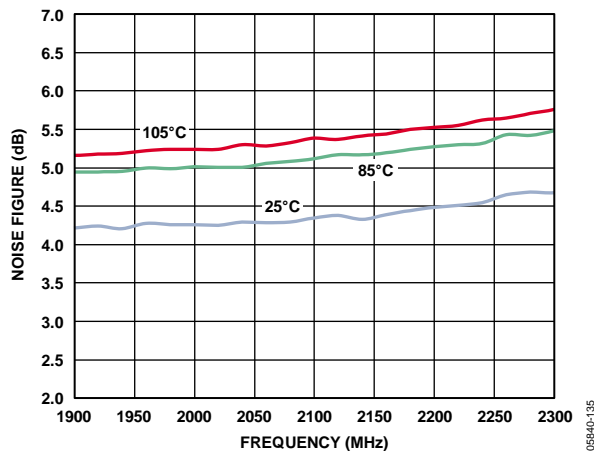

Figure 30. Noise Figure vs. Frequency and Temperature, 5 V Supply, 2060 MHz to 2200 MHz

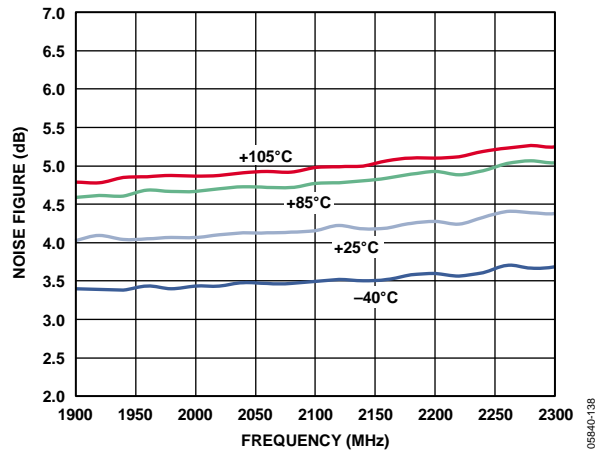

Figure 33. Noise Figure vs. Frequency and Temperature, 3.3 V Supply, 2060 MHz to 2200 MHz

APPLICATIONS INFORMATION

BASIC LAYOUT CONNECTIONS

The basic connections for operating the ADL5320 are shown in Figure 34. Table 6 lists the required matching components. Capacitors C1, C2, C3, C4, and C7 are Murata GRM155 series (0402 size) and Inductor L1 is a Coilcraft 0603CS series (0603 size). For all frequency bands, the placement of C3 and C7 are critical. From 2300 MHz to 2700 MHz, the placement of C2 is also important. Table 7 lists the recommended component placement for various frequencies.

A 5 V dc bias is supplied through L1 which is connected to RF_{OUT} (Pin 3). In addition to C4, 10 nF and 10 μ F power supply decoupling capacitors are also required. The typical current consumption for the ADL5320 is 110 mA.

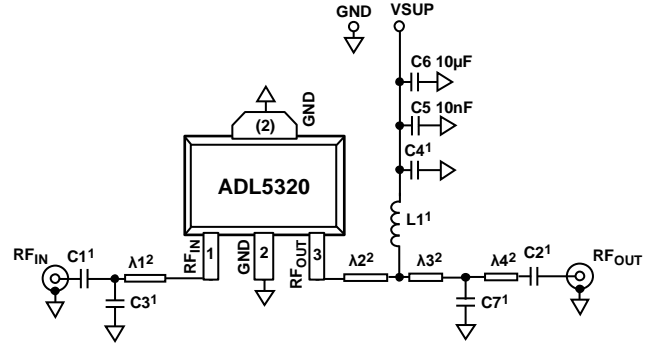

¹SEE TABLE 6 FOR FREQUENCY SPECIFIC COMPONENTS.
²SEE TABLE 7 FOR RECOMMENDED COMPONENT SPACING.

Figure 34. Basic Connections

05640-026

Table 6. Recommended Components for Basic Connections

Frequency (MHz)	C1 (pF)	C2 (pF)	C3 (pF)	C4 (pF)	C5 (nF)	C6 (μ F)	C7 (pF)	L1 (nH)
450 to 500	100	100	18	100	10	10	6.8	47
800 to 960	47	47	6.8	100	10	10	2.2	47
2110 to 2170	22	22	0.5	22	10	10	1.5	15
2300 to 2400	12	2.2	1.2	12	10	10	1.0	15
2500 to 2700	12	1.0	1.8	12	10	10	0.5	15

Table 7. Matching Component Spacing

Frequency (MHz)	λ 1 (mils)	λ 2 (mils)	λ 3 (mils)	λ 4 (mils)
450 to 500	391	75	364	50
800 to 960	200	75	100	350
2110 to 2170	300	75	175	275
2300 to 2400	225	75	125	125
2500 to 2700	142	75	89	75

SOLDERING INFORMATION AND RECOMMENDED PCB LAND PATTERN

Figure 35 shows the recommended land pattern for the ADL5320. To minimize thermal impedance, the exposed paddle on the SOT-89 package underside is soldered down to a ground plane along with Pin 2. If multiple ground layers exist, stitch them together using vias. For more information on land pattern design and layout, refer to the [Application Note AN-772, A Design and Manufacturing Guide for the Lead Frame Chip Scale Package \(LFCSP\)](#).

The land pattern on the ADL5320 evaluation board provides a measured thermal resistance (θ_{JA}) of 35°C/W. To measure θ_{JA} , the temperature at the top of the SOT-89 package is found with an IR temperature gun. Thermal simulation suggests a junction temperature 10°C higher than the top of the package temperature. With additional ambient temperature and input/output power measurements, θ_{JA} can be determined.

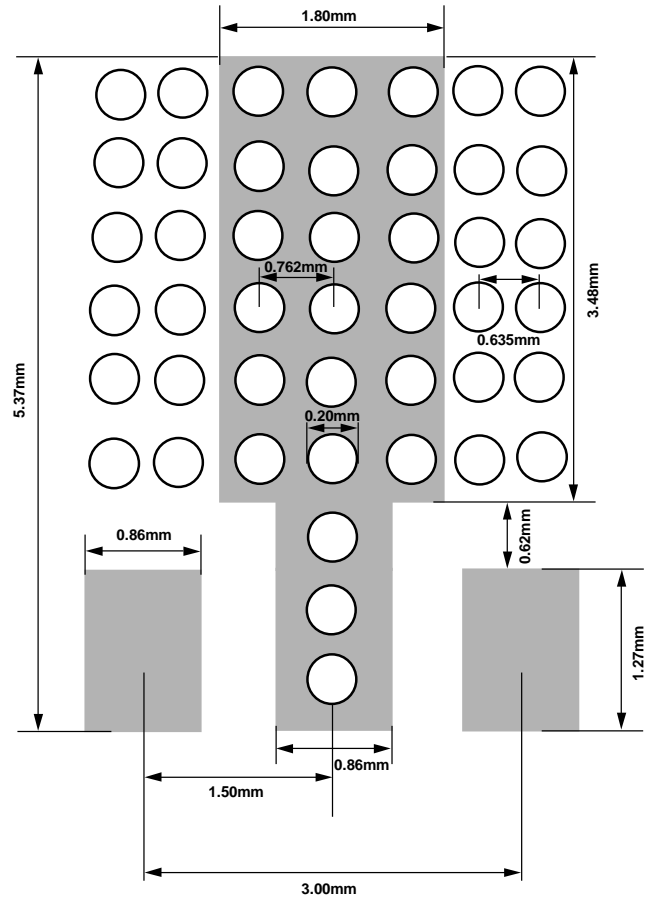

Figure 35. Recommended Land Pattern

0854-0041

MATCHING PROCEDURE

The ADL5320 is designed to achieve excellent gain and IP3 performance. To achieve this, both input and output matching networks must present specific impedance to the device. The matching components listed in Table 7 were chosen to provide -10 dB input return loss while maximizing OIP3. The load-pull plots (Figure 36, Figure 37, and Figure 38) show the load impedance points on the Smith chart where optimum OIP3, gain, and output power can be achieved. These load impedance values (that is, the impedance that the device sees when looking into the output matching network) are listed in Table 8 and Table 9 for maximum gain and maximum OIP3, respectively. The contours show how each parameter degrades as it is moved away from the optimum point.

From the data shown in Table 8 and Table 9, it becomes clear that maximum gain and maximum OIP3 do not occur at the same impedance. This can also be seen on the load-pull contours in Figure 36, Figure 37, and Figure 38. Thus, output matching generally involves compromising between gain and OIP3. In addition, the load-pull plots demonstrate that the quality of the output impedance match must be compromised to optimize gain and/or OIP3. In most applications, where line lengths are short and where the next device in the signal chain presents a low input return loss, compromising on the output match is acceptable.

To adjust the output match for operation at a different frequency or if a different trade-off between OIP3, gain, and output impedance is desired, the following procedure is recommended.

For example, to optimize the ADL5320 for optimum OIP3 and gain at 700 MHz, take the following steps:

1. Install the recommended tuning components for a 800 MHz to 960 MHz tuning band, but do not install C3 and C7.
2. Connect the evaluation board to a vector network analyzer so that input and output return loss can be viewed simultaneously.
3. Starting with the recommended values and positions for C3 and C7, adjust the positions of these capacitors along the transmission line until the return loss and gain are acceptable. Push-down capacitors that are mounted on small sticks can be used in this case as an alternative to soldering. If moving the component positions does not yield satisfactory results, then the values of C3 and C7 should be increased or decreased (most likely increased in this case as the user is tuning for a lower frequency). Repeat this process until the desired gain and return loss are achieved.
4. Once the desired gain and return loss are realized, OIP3 should be measured. Most likely, it will be necessary to go back and forth between return loss/gain and OIP3 measurements (probably compromising most on output return loss) until an acceptable compromise is achieved.

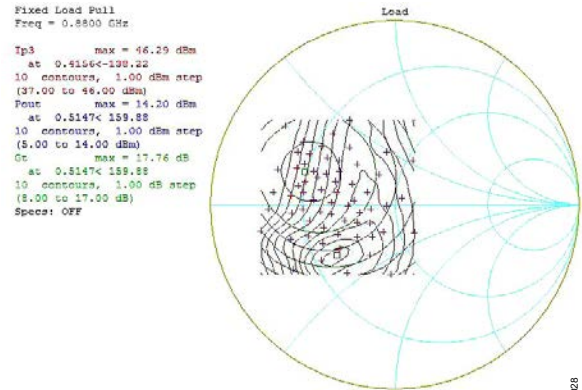

Figure 36. Load-Pull Contours, 880 MHz

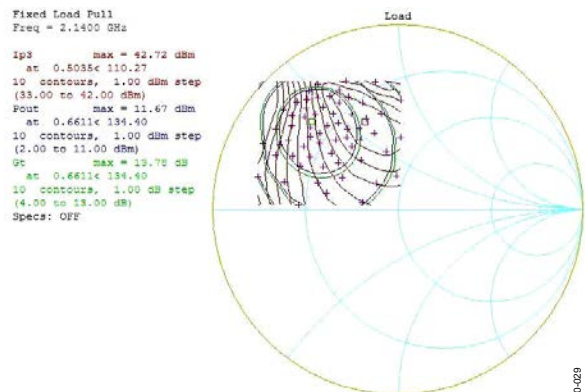

Figure 37. Load-Pull Contours, 2140 MHz

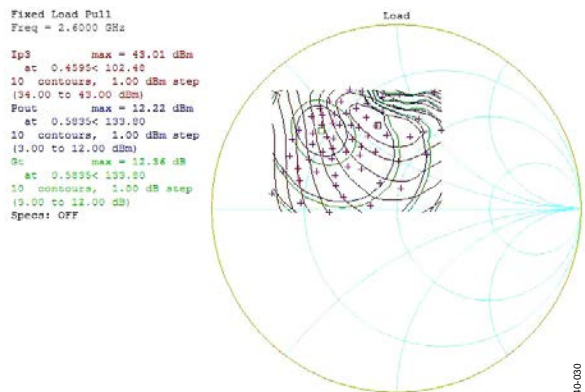

Figure 38. Load-Pull Contours, 2600 MHz

Table 8. Load Conditions for Gain_{MAX}

Frequency (MHz)	Γ_{Load} (Magnitude)	Γ_{Load} (°)	Gain _{MAX} (dB)
880	0.5147	159.88	17.76
2140	0.6611	134.40	13.78
2600	0.5835	133.80	12.36

Table 9. Load Conditions for IP3_{MAX}

Frequency (MHz)	Γ_{Load} (Magnitude)	Γ_{Load} (°)	IP3 _{MAX} (dBm)
880	0.4156	-138.22	46.29
2140	0.5035	+110.27	42.72
2600	0.4595	+102.48	43.01

OPTIMIZING OP1dB

In some applications, power handling (P1dB) is a more important parameter than IP3. In such cases, it is possible to retune the output load to increase the compression point of the ADL5320. Table 10 shows the performance of the ADL5320 after tuning the output load for higher OP1dB. Table 11 lists the component spacing, and Table 12 lists the component values.

Table 10. OP1dB, Gain, and IP3 Results with Optimized OP1dB

Frequency (MHz)	Gain (dB)	OIP3 (dBm)	OP1dB (dBm)
880	17.9	36	28.5
2140	13.5	40	28
2600	12.4	35	28.2

Table 11. Matching Component Spacing for Optimized OP1dB

Frequency (MHz)	λ_1 (mils)	λ_2 (mils)	λ_3 (mils)	λ_4 (mils)
800 to 960	200	75	339	100
2110 to 2170	300	75	89	275
2500 to 2700	142	75	89	75

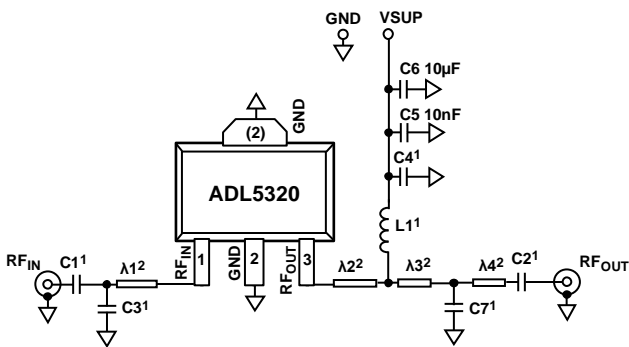

¹SEE TABLE 12 FOR FREQUENCY SPECIFIC COMPONENTS.
²SEE TABLE 11 FOR RECOMMENDED COMPONENT SPACING.

Figure 39. Component Values and Spacing for Increased OP1dB

05840-039

W-CDMA ACPR PERFORMANCE

Figure 40 shows a plot of adjacent channel power ratio (ACPR) vs. P_{OUT} for the ADL5320. The signal type being used is a single W-CDMA carrier (Test Model 1–64) at 2140 MHz. This signal is generated by a very low ACPR source. ACPR is measured at the output by a high dynamic range spectrum analyzer, which incorporates an instrument noise correction function.

The ADL5320 achieves an ACPR of –80 dBc at 0 dBm output, at which point device noise and not distortion is beginning to dominate the power in the adjacent channels. At an output power of 10 dBm, ACPR is still very low at –70 dBc, making the device particularly suitable for PA driver applications.

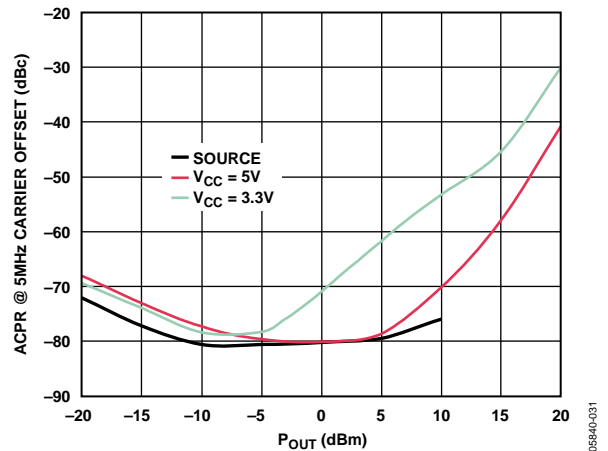

Figure 40. ACPR vs. P_{OUT}, Single Carrier W-CDMA (Test Model 1–64) at 2140 MHz Evaluation Board

05840-031

Table 12. Matching Component Values for Optimized OP1dB

Frequency (MHz)	C1 (pF)	C2 (pF)	C3 (pF)	C4 (pF)	C5 (nF)	C6 (μF)	C7 (pF)	L1 (nH)
800 to 960	47	47	6.8	100	10	10	5.6	47
2110 to 2170	22	22	0.5	22	10	10	1.8	15
2500 to 2700	12	1.0	1.8	12	10	10	1.0	15

EVALUATION BOARD

The schematic of the ADL5320 evaluation board is shown in Figure 41. This evaluation board uses 25 mil wide traces and is made from FR4 material. The evaluation board comes tuned for operation in the 2110 MHz to 2170 MHz tuning band. Tuning options for other frequency bands are also provided in Table 13. The recommended placement for these components is provided in Table 14. The inputs and outputs should be ac-coupled with appropriately sized capacitors. DC bias is provided to the amplifier via an inductor connected to the RF_{OUT} pin. A bias voltage of 5 V is recommended.

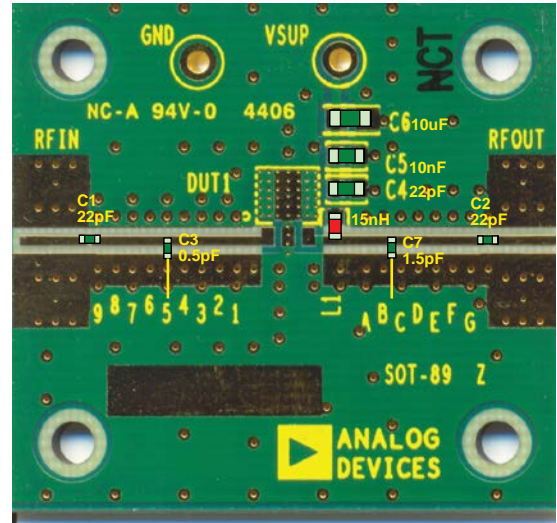

Figure 42. Evaluation Board Layout and Default Component Placement for Operation from 2110 MHz to 2170 MHz

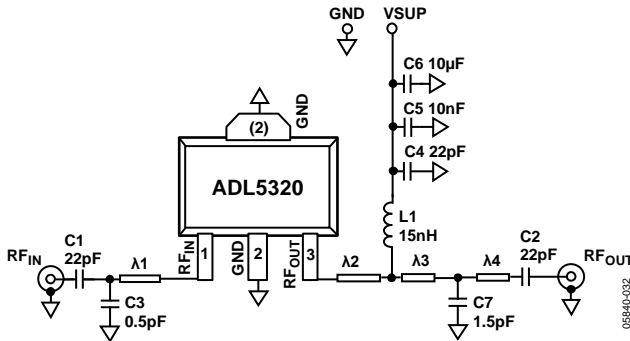

Figure 41. Evaluation Board, 2110 MHz to 2170 MHz

Table 13. Evaluation Board Configuration Options

Component	Function	450 MHz to 500 MHz	800 MHz to 960 MHz	2110 MHz to 2170 MHz (Default Configuration)	2300 MHz to 2400 MHz	2500 MHz to 2700 MHz
C1, C2	AC coupling capacitors	0402, 100 pF	0402, 47 pF	0402, 22pF	C1= 0402 12 pF, C2 = 0402 2.2 pF	C1 = 0402 12 pF, C2 = 0402 1.0 pF
C4, C5, C6	Power supply bypassing capacitors	C4 = 0603 100 pF, C5 = 0603 10 nF, C6 = 1206 10 μF	C4 = 0603 100 pF, C5 = 0603 10 nF, C6 = 1206 10 μF	C4 = 0402 22pF, C5 = 0603 10 nF, C6 = 1206 10 μF	C4 = 0603 12 pF, C5 = 0603 10 nF, C6 = 1206 10 μF	C4 = 0603 12 pF, C5 = 0603 10 nF, C6 = 1206 10 μF
L1	DC bias inductor	0603, 47 nH	0603, 47 nH	0603, 15 nH	0603, 15 nH	0603, 15 nH
C3, C7	Tuning capacitors	C3 = 0402 18 pF, C7 = 0402 6.8 pF	C3 = 0402 6.8 pF, C7 = 0402 2.2 pF	C3 = 0402 0.5 pF, C7 = 0402 1.5 pF	C3 = 0402 1.2 pF, C7 = 0402 1.0 pF	C3 = 0402 1.8 pF, C7 = 0402 0.5 pF
R1					R1 = 0402 0 Ω	R1 = 0402 0 Ω
VSUP, GND	Power supply connections	VSUP red test loop, GND black test loop	VSUP red test loop, GND black test loop	VSUP red test loop, GND black test loop	VSUP red test loop, GND black test loop	VSUP red test loop, GND black test loop

Table 14. Recommended Component Spacing on Evaluation Board

Frequency (MHz)	λ1 (mils)	λ2 (mils)	λ3 (mils)	λ4 (mils)
450 to 500	391	75	364	50
800 to 960	200	75	100	350
2110 to 2170	300	75	175	275
2300 to 2400	225	75	125	125
2500 to 2700	142	75	89	75

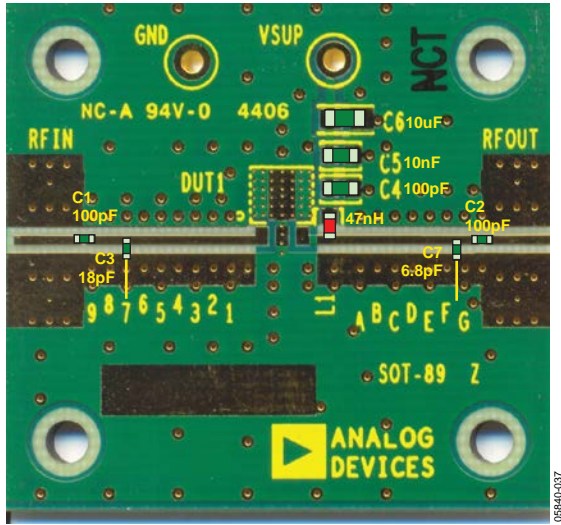

Figure 43. Evaluation Board Layout and Component Placement
450 MHz to 500 MHz Operation

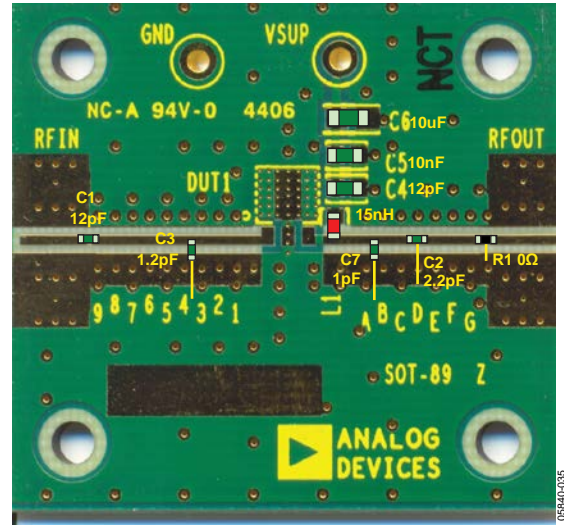

Figure 45. Evaluation Board Layout and Component Placement
2300 MHz to 2400 MHz Operation

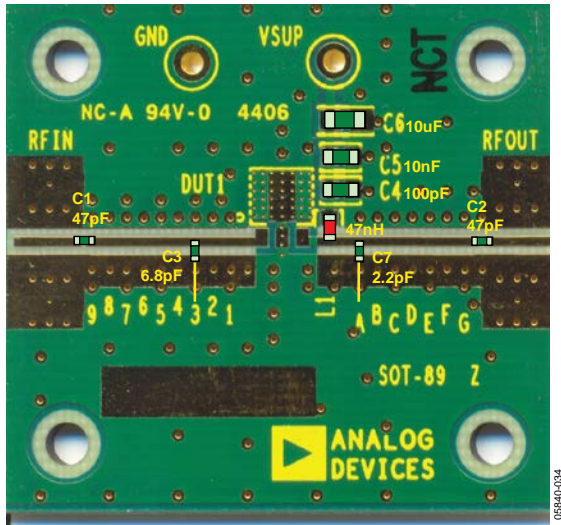

Figure 44. Evaluation Board Layout and Component Placement
800 MHz to 960 MHz Operation

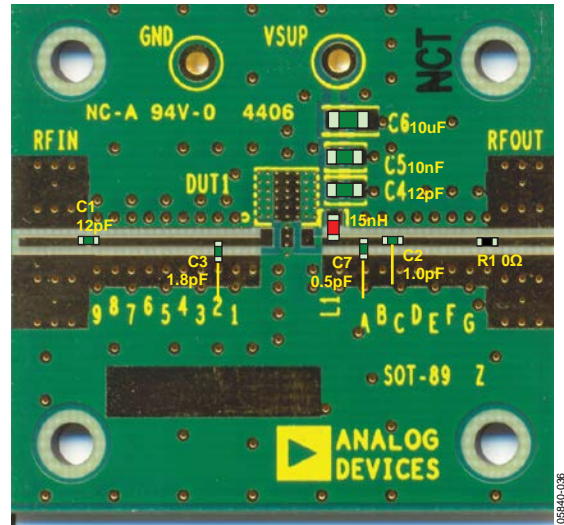
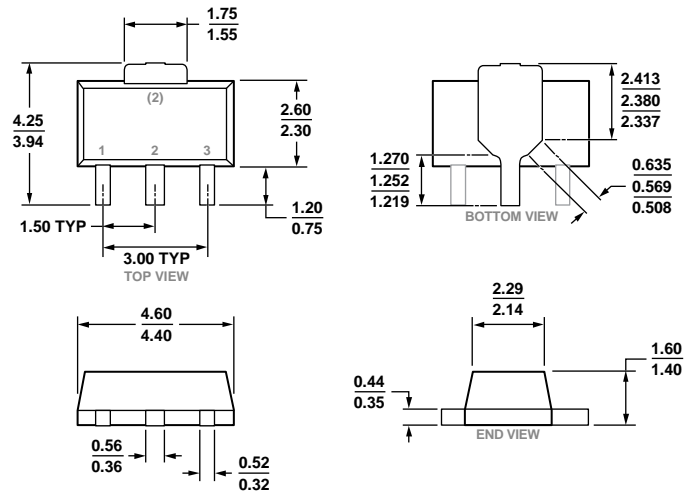

Figure 46. Evaluation Board Layout and Component Placement
2500 MHz to 2700 MHz Operation

OUTLINE DIMENSIONS



COMPLIANT TO JEDEC STANDARDS TO-243

Figure 47. 3-Lead Small Outline Transistor Package [SOT-89] (RK-3)
Dimensions shown in millimeters

ORDERING GUIDE

Model ¹	Temperature Range	Package Description	Package Option
ADL5320ARKZ-R7	-40°C to +105°C	3-Lead SOT-89, 7" Tape and Reel	RK-3
ADL5320-EVALZ		Evaluation Board	

¹ Z = RoHS Compliant Part.

NOTES

NOTES